

SUZUKI

DR 250/250S
DR 350/350S

OIL COOLER SET

INSTALLATION MANUAL

FOREWORD

This manual contains instructions for proper installation of the oil cooler set on models DR250, DR250S, DR350 and DR350S.

Before carrying out the installation work, read this manual thoroughly and try to make clear all information and procedures involved with the installation. When installing the oil cooler, be sure to follow all the instructions and procedures described.

CONTENTS

COMPONENT PARTS	1
INSTALLATION	2

COMPONENT PARTS

The oil cooler set consists of the parts shown in the illustration below. Upon unpacking the carton, check to make sure all of these parts are contained.

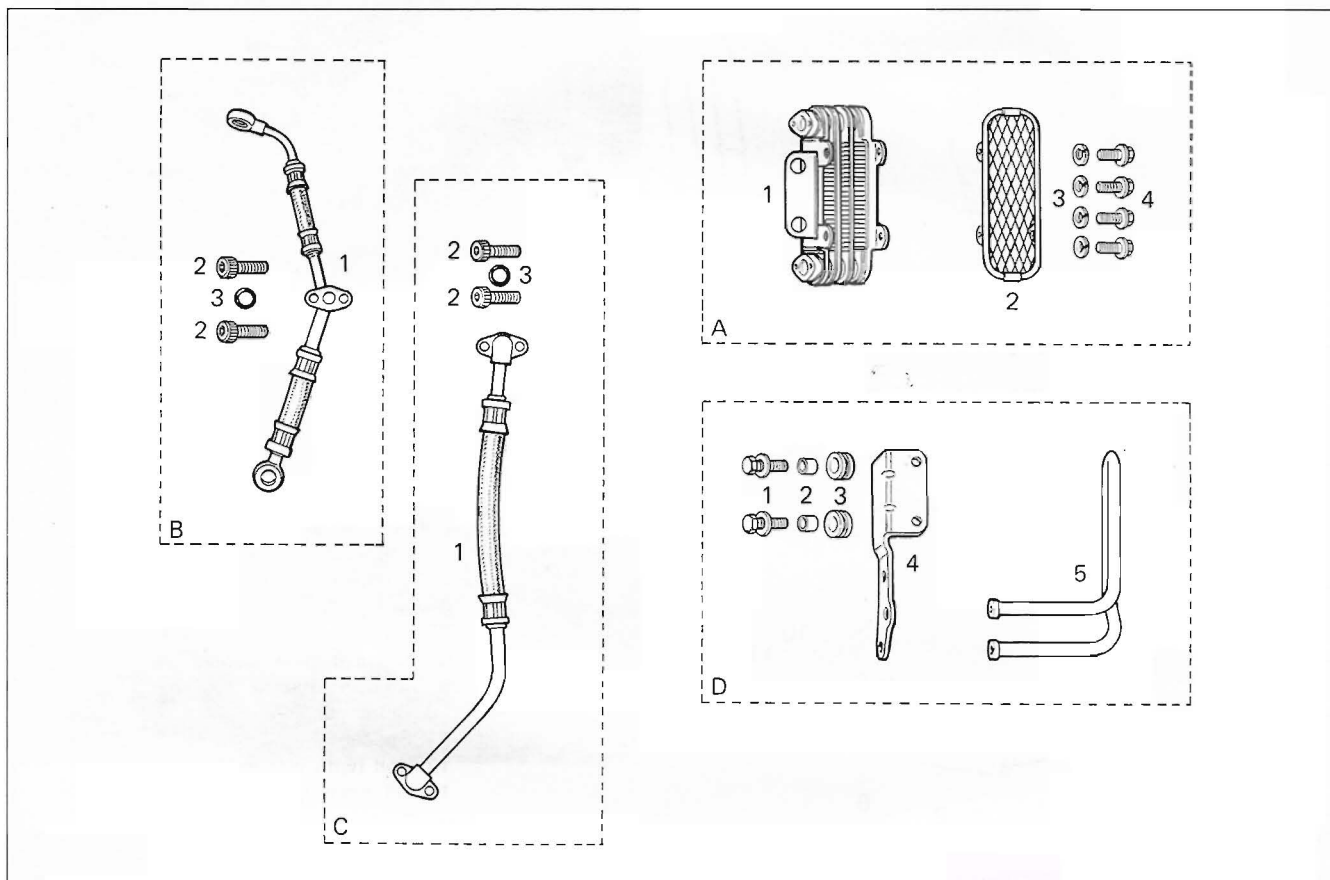

Item	Part Name	Q'ty	Remarks
A1	Oil cooler assembly	1	
2	Oil cooler bumper	1	
3	Lock washer	4	
4	Bolt, bumper	4	
B1	Oil cooler hose (Upper)	1	
2	Bolt, oil hose	2	
3	O-ring, oil hose	1	

Item	Part Name	Q'ty	Remarks
C1	Oil cooler hose (Lower)	1	
2	Bolt, oil hose	2	
3	O-ring, oil hose	2	
D1	Bolt, oil cooler	2	
2	Spacer, oil cooler	2	
3	Cushion, oil cooler	2	
4	Oil cooler bracket	1	
5	Oil cooler guard	1	

ASSEMBLING OIL COOLER COMPONENTS

Prior to installation, assemble the set component parts referring to the following illustration.

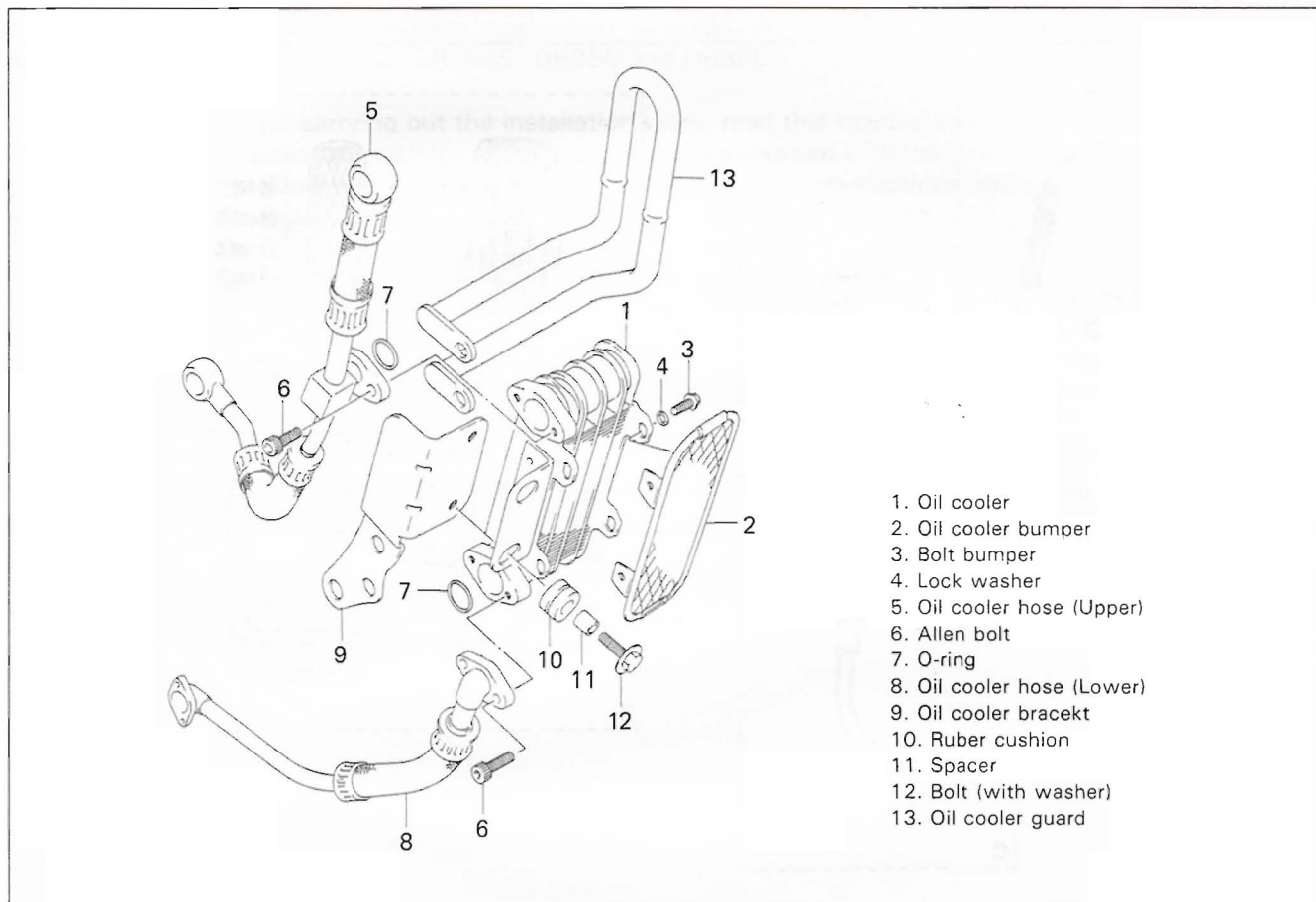

NOTE:
At this stage, the oil cooler guard ⑬ is not assembled.

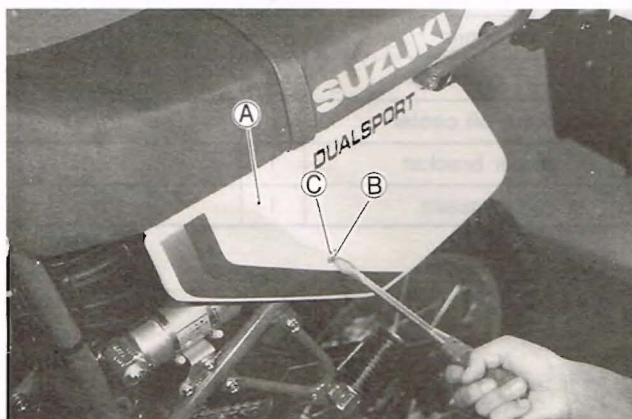

INSTALLATION

REMOVING PARTS FROM MOTORCYCLE

To make possible the installation of oil cooler as an assembly on the motorcycle, some parts should be temporarily removed from the motorcycle. The parts removal procedures are as follows:

1. Remove the frame covers, right and left, after removing the attaching screw and stepped washer.

- A: Frame cover
- B: Screw
- C: Stepped washer



2. Remove two bolts and dismount the seat.

A: Seat
B: Bolt

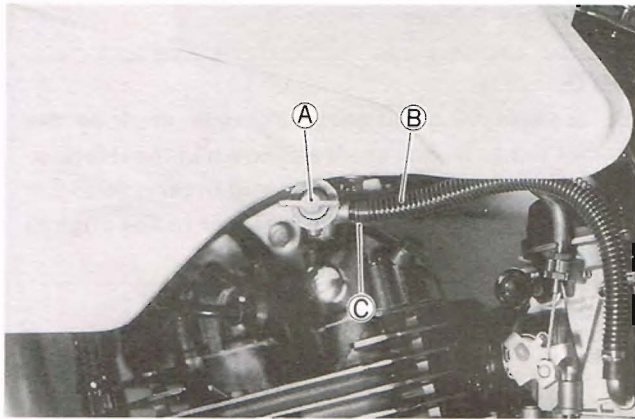

3. Turn the fuel cock to "OFF" position and disconnect the fuel hose from the fuel cock.

A: Fuel cock
B: Fuel hose
C: Clip

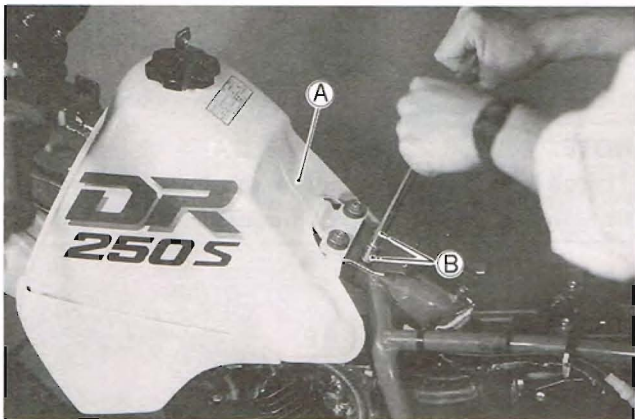

4. Loosen two the mounting bolts and remove the fuel tank from the frame.

A: Fuel tank
B: Bolt

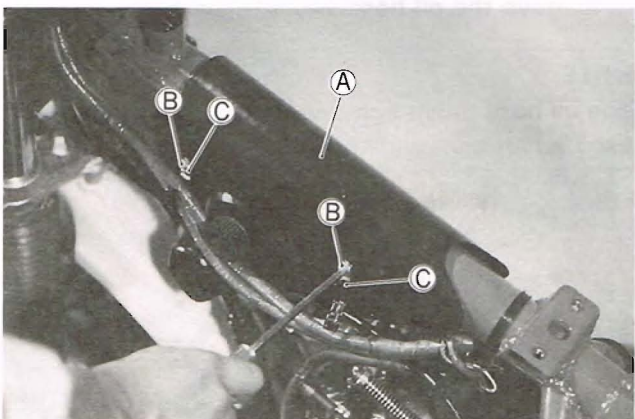

5. Remove the wiring harness clamp. Also remove the protector from the frame after loosening its four attaching screws.

A: Protector
B: Screw
C: Harness clamp

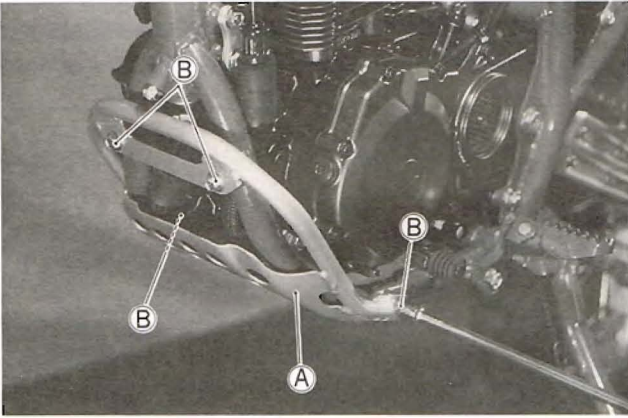

6. Remove the engine guard after loosening four attaching bolts.

A: Engine guard
B: Bolt

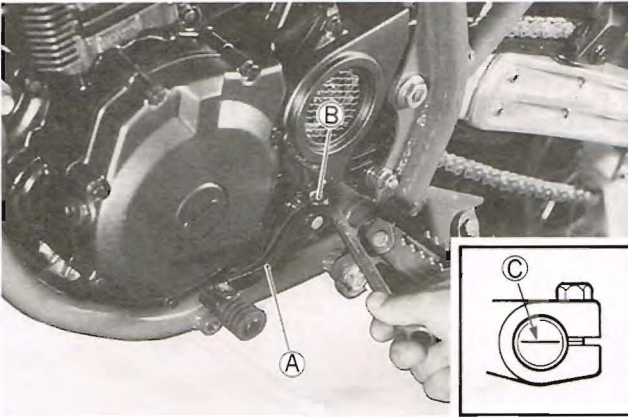

7. Remove the gearshift lever.

NOTE:

Before removing the gearshift lever, mark on the end of the gearshift shaft as shown in the left photo to indicate the lever's slit position relative to the shaft. This will help locate the lever to the original position at the time of reinstallation.

A: Gearshift lever
B: Bolt
C: Mark

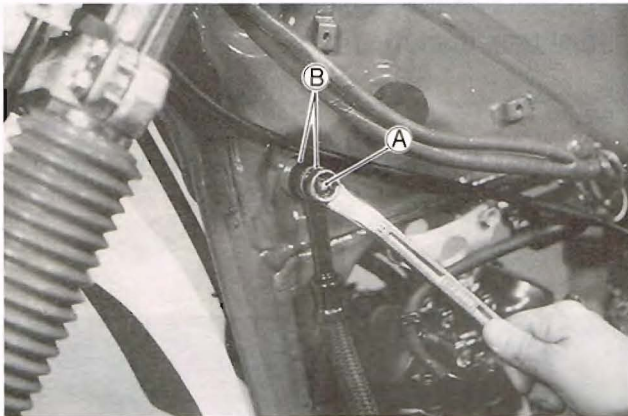

8. Place a suitable oil drain pan under the engine. As shown in the photo, remove the oil hose upper union bolt.

NOTE:

The oil hose union bolt and its gaskets will be re-used when installing the oil cooler.

A: Bolt
B: Gasket

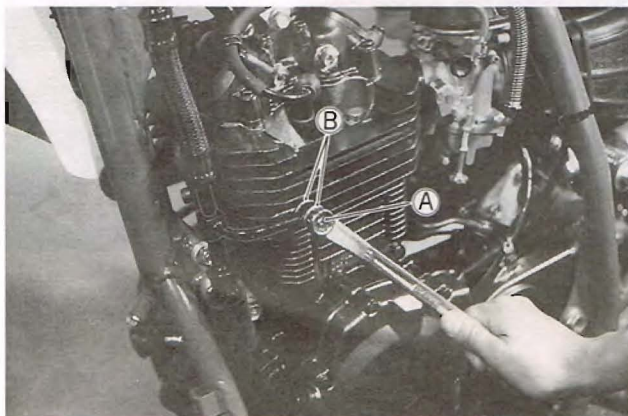

9. Remove the oil hose lower union bolt.

NOTE:

The oil hose union bolt and its gaskets will be re-used when installing the oil cooler.

A: Bolt
B: Gasket

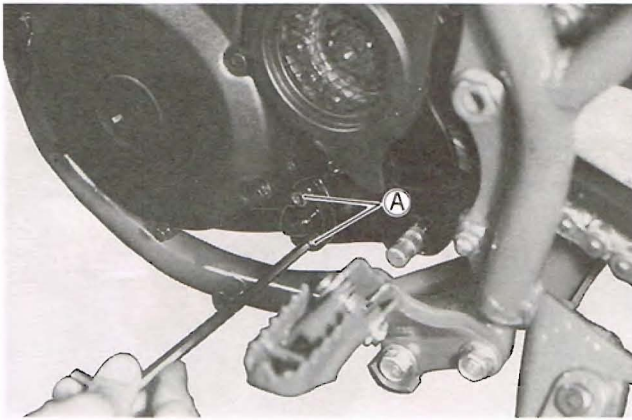

10. Remove the lower oil hose fitting bolts.

NOTE:

The "O" ring and two fitting bolts will be reused when installing the oil cooler.

A: Bolt

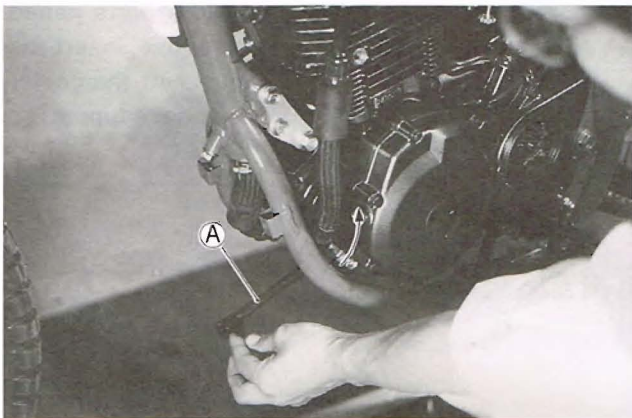

11. Remove the oil hose from the motorcycle as shown in the photo.

A: Oil hose

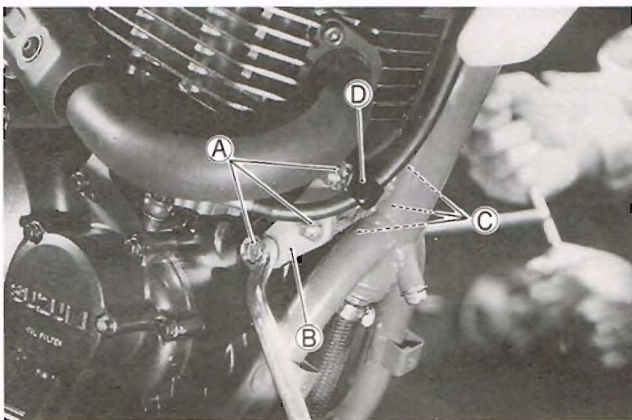

12. Remove the engine mounting bolts, nuts and plates.

NOTE:

The engine right mounting plate will be reused when installing the oil cooler.

A: Nut
B: Plate
C: Bolt
D: Clamp

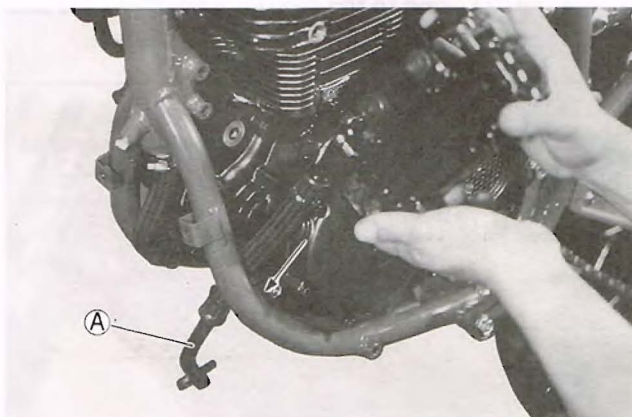

INSTALLING OIL COOLER ASSEMBLY

1. Pass the oil cooler hose (lower) between the engine and frame as shown in the photo.

A: Oil cooler hose (Lower)

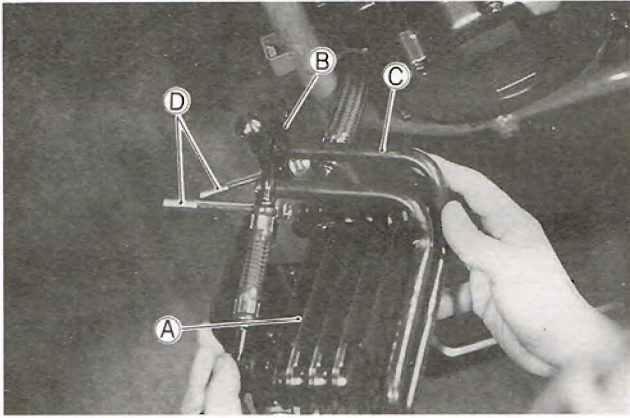

2. Insert the 8-mm bolt into the hole provided in both the oil cooler guard and oil cooler bracket.

- A: Oil cooler assembly
- B: Oil cooler bracket
- C: Oil cooler guard
- D: 8 mm bolt

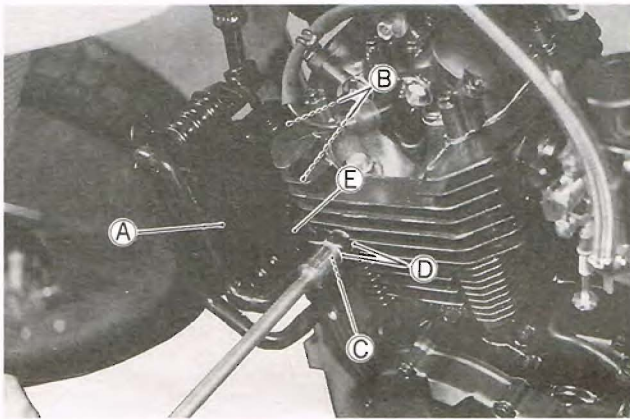

3. With the oil cooler and the relate parts joined together with the 8-mm bolt as above, insert the 8-mm bolt into the chassis to mount the cooler assembly. Connect the oil cooler hose (upper) to the engine.

- A: Oil cooler assembly
- B: Bolt
- C: Oil hose union bolt
- D: Gasket
- E: Oil cooler hose (Upper)

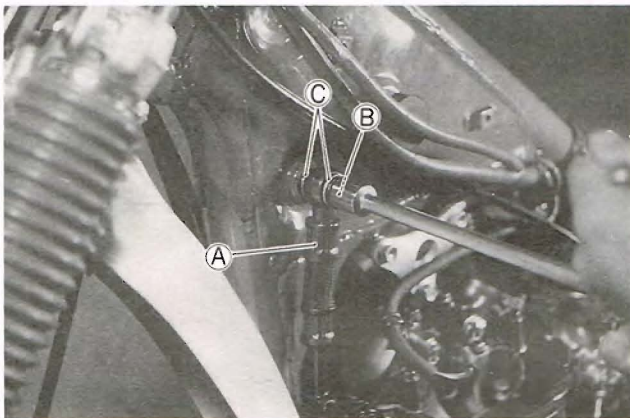

4. Install the oil cooler hose (upper).

- A: Oil cooler hose (Upper)
- B: Union bolt
- C: Gasket

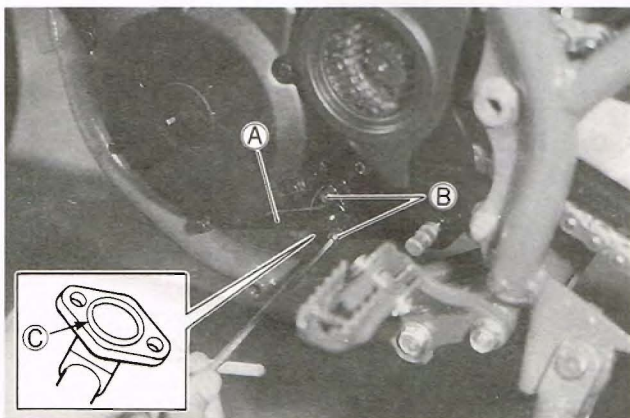

5. Fit the "O" ring to the oil cooler hose (lower) and attach the hose connector to the engine.

NOTE:

When fitting the "O" ring to the hose, apply grease to prevent it from coming off during handling.

- A: Oil cooler hose (Lower)
- B: Bolt
- C: O-ring

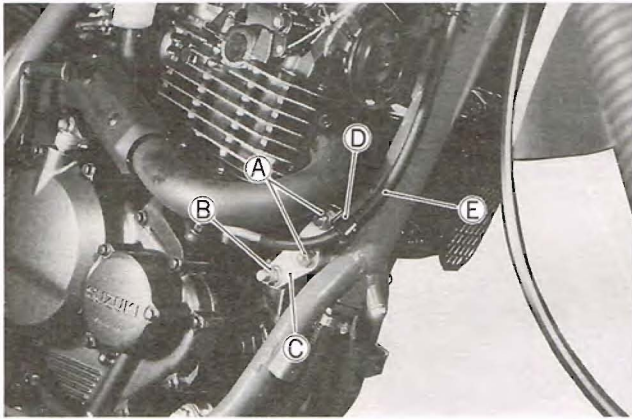

6. Install the oil cooler assembly to the frame using 10-mm bolts, nuts and plate. As shown in the photo, install the clutch cable clamp together to the upper bolt. Clamp the clutch cable.

Tightening torque

	kg-m	lb-ft	N·m
Ⓐ	1.8–2.8	13.0–20.0	18.0–28.0
Ⓑ	6.0–7.2	43.5–52.0	60.0–72.0

A: Nut 8 mm
 B: Nut 10 mm
 C: Plate
 D: Clamp
 E: Clutch cable

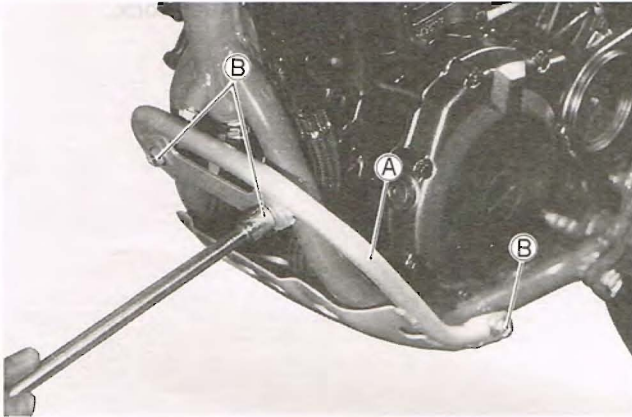

REINSTALLING PARTS PREVIOUSLY REMOVED

1. Install the engine guard using four bolts.

A: Engine guard
 B: Bolt

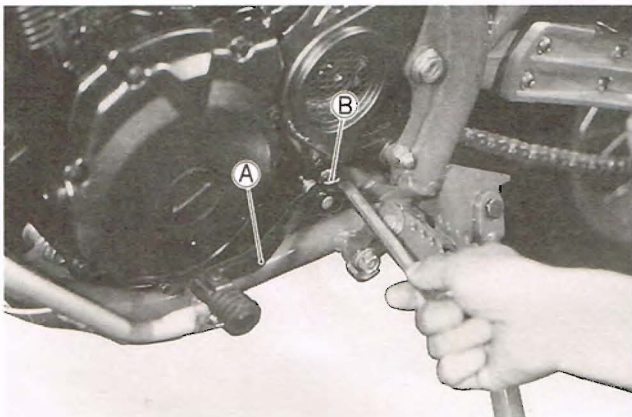

2. Install the gearshift lever.

A: Gearshift lever
 B: Bolt

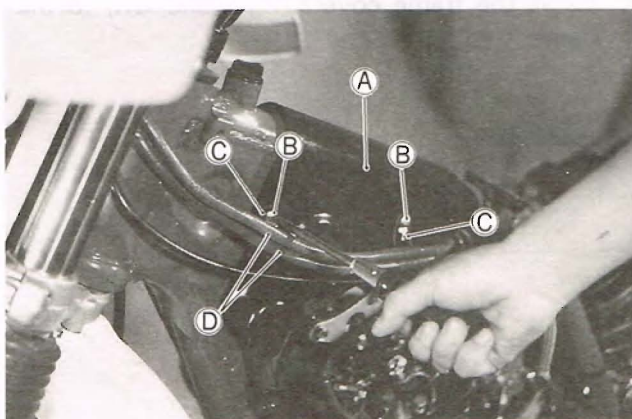

3. Install the protector to the frame using four screws.

NOTE:
 Install the wiring harness clamp together to the left attaching screw.
 Clamp the wiring harness.

A: Protector
 B: Screw
 C: Harness clamp
 D: Wiring harness



4. Fit the fuel tank mounting bracket to the cushion and install the fuel tank to the frame using two bolts.

A: Fuel tank
 B: Cushion
 C: Bolt

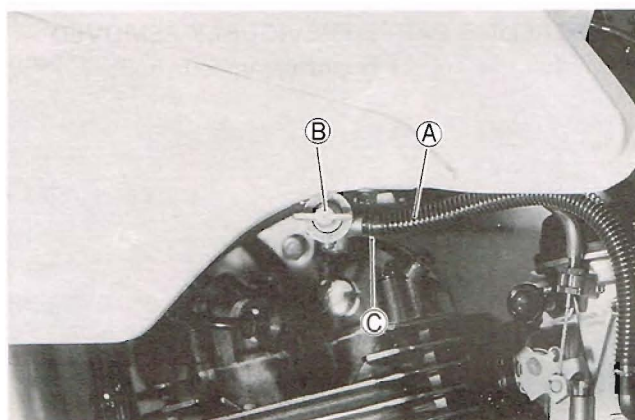

5. Connect the fuel hose to the fuel cock.

A: Fuel hose
 B: Fuel cock
 C: Clip



6. Mount the seat to the frame.

A: Seat
 B: Bolt

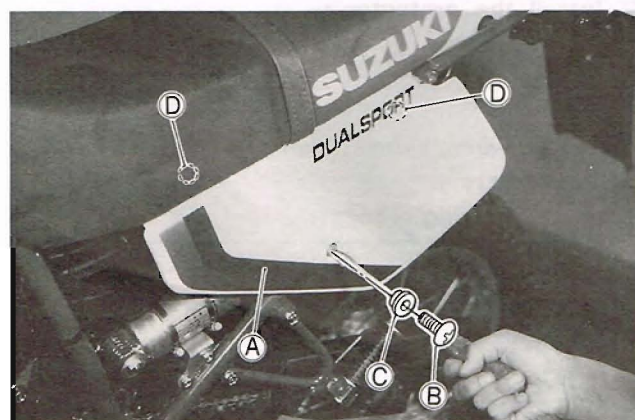

7. Install the frame covers, right and left, to the frame.

A: Frame cover
 B: Screw
 C: Stepped washer
 D: Boss

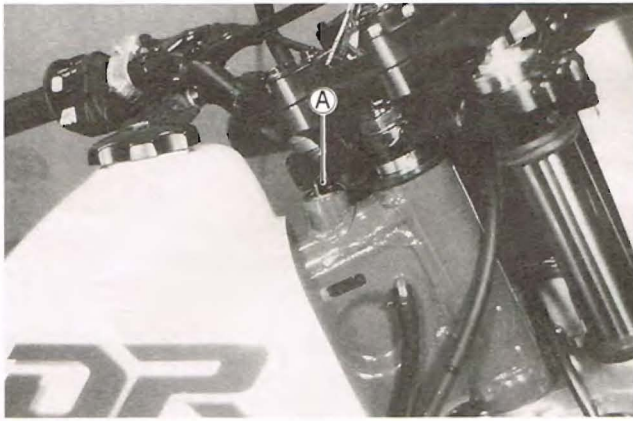

CHECKING ENGINE OIL LEVEL

Check the engine oil level. If the level is not sufficient, replenish it.

NOTE:

For details, refer to Owners Manual.

A: Engine oil filler plug
(Engine oil dipstick)