

**850-T**



**owner's manual**



*Dear rider,*

*First of all we wish to thank you for choosing this motorcycle of our production.*

*By following the instructions outlined in this manual you will ensure your bike a long and troublefree life.*

*Before riding, please read thoroughly this manual in order to know your motorcycle's features and how to operate it safely.*

*All major checking and overhaul jobs are best carried out by our dealers who have the necessary facilities to quickly and competently repair your Moto Guzzi.*

*Repairs or adjustments by other than a Guzzi dealer during the warranty period could invalidate the warranty right.*



# INDEX

- 4 Main features
- 10 Controls and accessories
- 12 Identification data
- 13 Instruments and controls
- 19 Riding instructions
- 22 Maintenance
- 28 Removal of wheels
- 31 Lubrication and maintenance chart
- 36 Lubrications
- 39 Carburation
- 42 Valve gearing
- 43 Ignition - Checking and adjustment of double contact breaker
- 45 Checking of Ignition timing «fixed advance»
- 47 Electrical equipment

## 4 MAIN FEATURES

### Engine

2-cylinder 4-stroke	
Cylinder disposition	«V» 90°
Bore	mm 83
Stroke	mm 78
Displacement	cc 844
Compression ratio	9,5
Revs. at max. engine speed	7000 r.p.m.
Maximum horsepower	HP 68

### Valve gear

O.H.V. push rod operated.  
Timing data:  
*inlet:* opens 20° before TDC  
          closes 52° after BDC  
*exhaust:* opens 52° before BDC  
            closes 20° after TDC  
Rocker clearance for valve timing mm 1,5.  
Normal rocker clearance, **cold engine**, mm 0,22.

### Carburation

2 Dell'Orto carburetors type VHB 30 CD (right),  
VHB 30 CS (left).

<b>Lubrication</b>	Pressure, by gear pump. Normal lubrication pressure $3,8 \div 4,2$ kg/sqcm (controlled by relief-valve). Electrically controlled oil pressure gauge.
<b>Generator</b>	Front (14 V - 13 A) on the mainshaft.
<b>Ignition</b>	By battery, with double contact breaker and automatic advance.
<b>Ignition data</b>	Initial advance <span style="float: right;">8°</span> Automatic advance <span style="float: right;">26°</span> Full advance <span style="float: right;">34°</span> Contact breaker gap mm $0,42 \div 0,48$ Spark plugs: long thread ( $\varnothing$ 14 x 1,25) Thermal degree 240 Plug points gap mm 0,6 2 ignition coils.
<b>Starting</b>	Electric starter with electromagnetic ratchet control. Ring gear bolted on flywheel. Starter button, right on the handlebar.

## Transmission

<b>Clutch</b>	Dry type, twin plates, flywheel driven. Controlled by lever, on the handlebar (left).
<b>Gear box</b>	<p>Five speeds, frontal engagement, constant mesh gears. Cush drive incorporated. Controlled by pedal on the left side of the motorcycle.</p> <p><i>Bevel gear ratio:</i> 1 : 4,625 (<math>Z = 8-37</math>).</p> <p>Overall gear ratios:</p> <p>low gear = 1 : 11,424 second gear = 1 : 7,928 third gear = 1 : 5,980 fourth gear = 1 : 4,963 top gear = 1 : 4,284</p>
<b>Frame</b>	Duplex cradle, tubular structure.
<b>Suspension</b>	<p>Telescopic front fork incorporating hydraulic dampers. Rear swinging fork with externally adjustable springs.</p>
<b>Wheels</b>	Spoked rims, WM 3/2,15 x 18 front and rear.



**Tires**

Front 3,50 H - 18 S 41 studded.

Rear 4,10 H - 18 S 41 studded.

Pressure:

front	solo	}	1,8	kg/sqcm
	with passenger			
rear	solo		2,2	kg/sqcm
	with passenger			

*The above data are for normal riding (cruising speed). If using the motorcycle at constant high speed or on motorways, it is recommended to increase pressure by 0,2 kg/sqcm.*

**Brakes**

Front: hydraulic disc brake. Disc  $\varnothing$  mm 300.  
Controlled by lever, right on the handlebar.

Rear: expansion type ( $\varnothing$  220 x 25). Controlled by pedal on the right side of the motorcycle.

**Dimensions and weights**

Wheelbase m 1,470

Max. width m 0,780

Max. length m 2,200

Max. height m 1,060

Min. ground clearance m 0,150

Engine weight (dry) with carburetors and elec-



Passing of a 55 feet long truck travelling at 50 m.p.h.

— Time: 8,7 seconds

— Distance travelled: 900 feet

The above includes a safety distance of 40 and 100 feet respectively between the passing and pace vehicle at the beginning and end of the manoeuvre.

**Braking ability**

Stopping distance from 60 m.p.h. (solo, using both brakes): 177 feet.

Stopping distance with passenger from 60 m.p.h. (using both brakes): 193 feet.

**Fuel and oil capacities**

<b>Group or part</b>	<b>Quantity</b>	<b>Recommendation</b>
Fuel tank	I. 25 }	Petrol 98/100 NO-RM
Reserve	I. 4 }	
Sump	I. 3,5	Agip F.1 Supermotoroil SAE 20 W/50
Gear box	I. 0,750	Agip F.1 Rotra MP SAE 90
Rear drive box (bevel set lubrication)	I. 0,340	Agip F.1 Rotra MP SAE 90
	I. 0,020	Molykote type A
Front fork (each leg)	I. 0,050	Agip F.1 ATF Dexron
Front brake		Agip F.1 Brake fluid

## 10 CONTROLS AND ACCESSORIES

(fig. 2)

- |    |  |    |  |
|----|--|----|--|
| 1  | Front brake disc.                      | 14 | Indicator panel.                               |
| 2  | Front brake pliers.                    | 15 | Mile counter.                                  |
| 3  | Pump and fluid reservoir, front brake. | 16 | Rev-counter.                                   |
| 4  | Front brake control lever.             | 17 | Clutch control lever.                          |
| 5  | Throttle control grip.                 | 18 | Horn, flashing light and turn signals buttons. |
| 6  | Starter and engine emergency stop.     | 19 | Lighting switch.                               |
| 7  | Key switch.                            | 20 | Gearshift pedal.                               |
| 8  | Fuel filler cap.                       | 21 | Rear turn signals.                             |
| 9  | Rear brake pedal.                      | 22 | Rear light.                                    |
| 10 | Footrest                               |    |  |
| 11 | Footrest passenger.                    |    |  |
| 12 | Headlight.                             |    |  |
| 13 | Front turn signals.                    |    |  |

*Right and left are intended as it seen in riding position.*

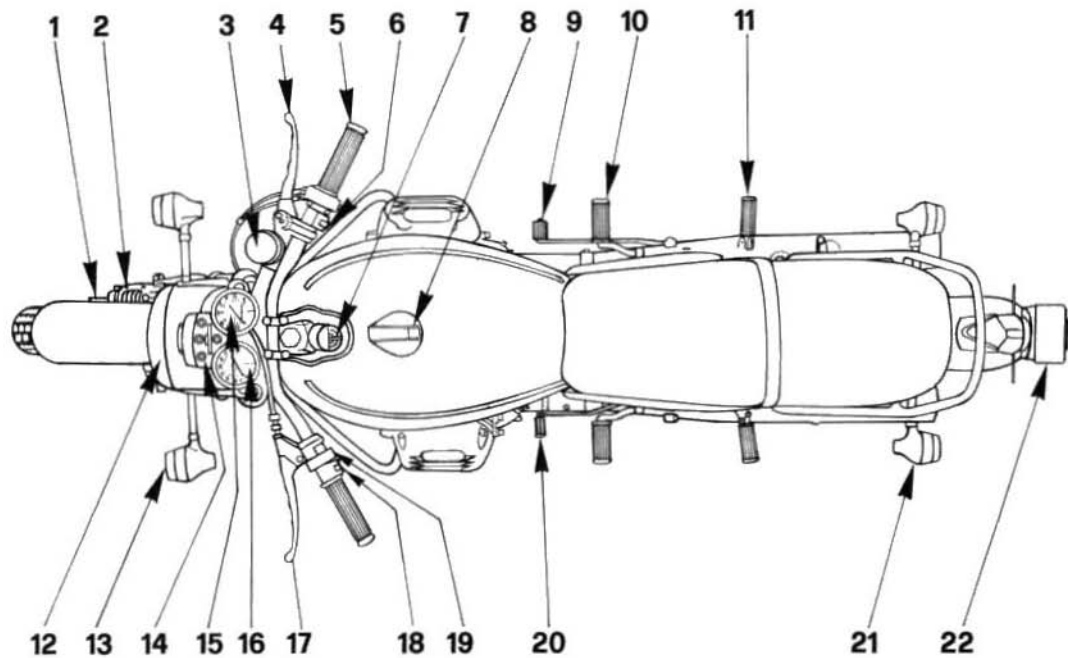



## INSTRUMENTS AND CONTROLS

### Instrument panel

(fig. 4)

- 1 Mile counter.
- 2 Rev.-counter.
- 3 Red warning light indicating insufficient current from the generator for battery charge. It must go out when the engine reaches a certain number of revolutions.

4 Orange neutral indicator. It lights when the gearbox is in neutral position. It may be well to make sure that this position is correct. In any case it is a good practice to pull the clutch before starting.

5 Red warning light. Oil pressure gauge. It goes

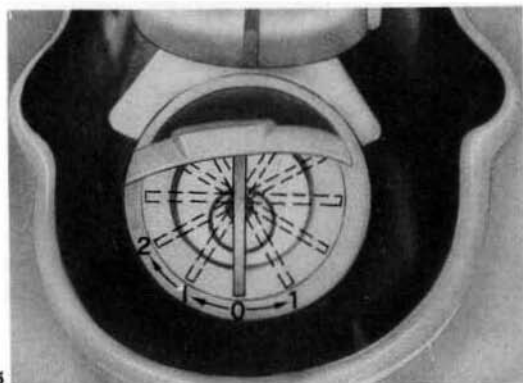
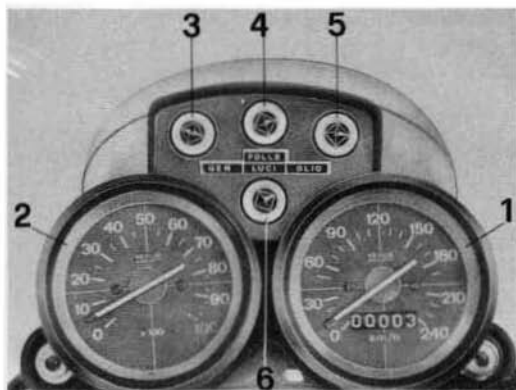

14 out when the pressure is sufficient for normal engine lubrication. Should it not go out, the pressure is not correct; in this case the engine has to be stopped and suitable checkings are to be carried out.

6 High beam warning light (red).

*By day riding all warning lights are to be out.*

## Ignition key and steering lock

The key has four positions (fig. 5):

- |                       |   |
|-----------------------|---|
| «0»                   | Standstill, key not removable.  |
| «1»                   | Turned anticlockwise, standstill, key removable. Steering locked on removal of key and turning of the handlebar right or left.                |
| «1»<br>(intermediate) | Turned clockwise, between position «0» and position «2», key removable. In this position the key can be removed without locking the steering. |
| «2»                   | Turned clockwise, ready to start, all controls are in.  |



## Lights switch

Left, on the handlebar, 4 positions (fig. 6 «B»).

- «1» OFF Lights off.
- «2» PARK Rear light.
- «3» L Low beam.
- «4» H High beam.
- «5» Safety (to come back to position OFF press the button towards the left).

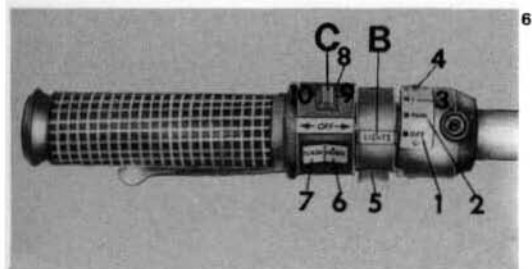

## Horn, flashing light and turn signals

Left, on the handlebar (fig. 6 «C»).

- « 6 » HORN Horn button.
- « 7 » FLASH Flashing light button.
- « 8 » Turn signals button.
- « 9 » When turned to the right operates the right signals.
- «10» When turned to the left operates the left signals.

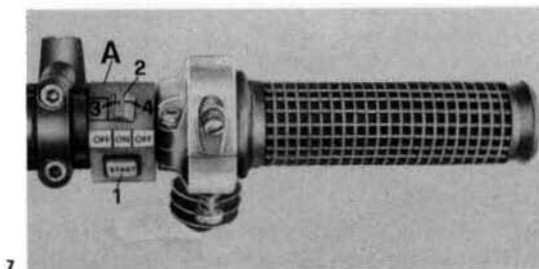

## 16 Starting and engine emergency stop

Right, on the handlebar (fig. 7 «A»).

With the ignition key in position «2» the motorcycle is ready to be started. To start the engine (see «A») press the button «1» START.

To stop the engine (in case of emergency) turn the button in position «3» or «4» OFF.

## Carburetor starter control

The two levers for starting a **cold engine** are located left on the left carburetor and right on the right carburetor (fig. 23).

«A» Starting position.

«B» Riding position

## Throttle control

Right on the handlebar; throttle is opened by turning toward the rider and closed viceversa.

## Clutch control lever

Left on the handlebar, to be used for starting and gearshifting only.

## Front brake control lever

Right on the handlebar, connected with the brake pump fluid reservoir.

## Rear brake pedal

On the right side of the motorcycle.

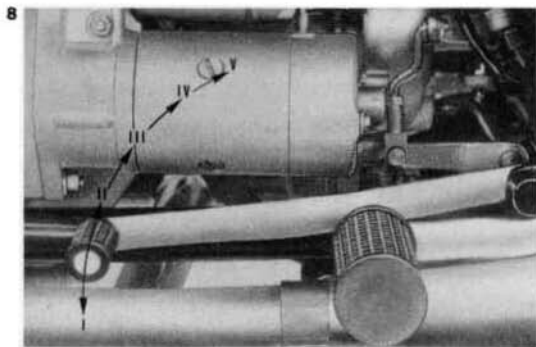

## Gearshift pedal

On the left side of the motorcycle (fig. 8).

Low gear: pedal down.

2. 3. 4. and top gear: pedal up.

Neutral position: between low and 2nd gear.

*Before operating the gearshift pedal, the clutch lever has to be completely pulled in.*

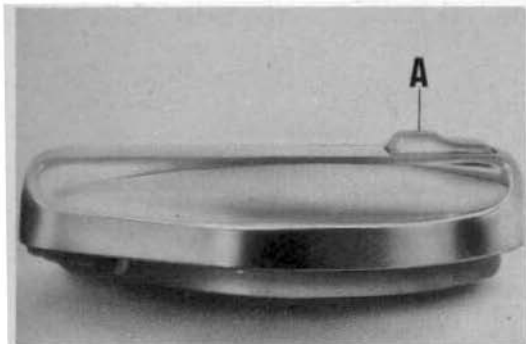

## Fuel filler cap

17

To open it, press the control button «A» (fig. 9).

## Fuel taps

They are located rear, under the fuel tank (fig. 10).

Positions:

«A» Open (vertical).

«R» Reserve (horizontal) see «R» on the taps.

«C» Closed (horizontal) see «C» on the taps.

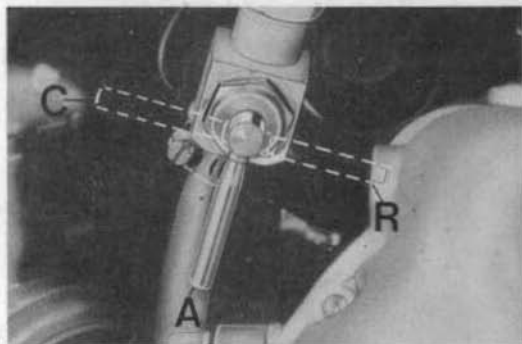

## 18 Terminal block with fuses

It is located under the seat (fig. 11) and holds n. 6 15 A fuses.

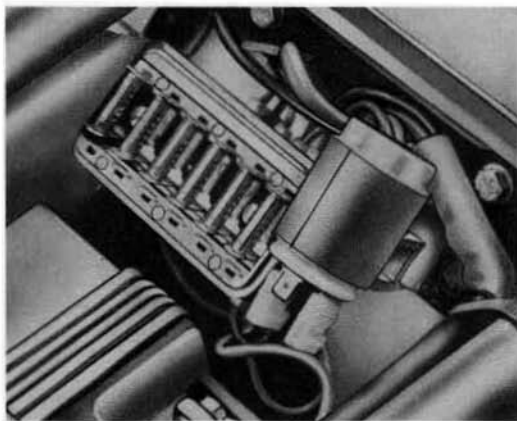

## RIDING INSTRUCTIONS

### Checking

Before starting the engine ensure that:

- there is sufficient fuel in the tank;
- the oil in the engine sump is at correct level;
- the ignition key is in position «2» (see fig. 5);
- the warning lights: **red** (oil pressure gauge and generator); **orange** (neutral indicator) are lit;
- the starter levers on the carburetors, for cold engine are in starting position (vertical) see «A» in fig. 23.

### Engine starting

After the first checking, turn the twist grip 1/4 towards the rider and push the start button, right on the handlebar «1» START in fig. 7.

After the engine has been started, before returning the starter control levers into riding position

(horizontal) see «B» in fig. 23, let the engine idle a short while in the hot season and a few minutes in the cold season.

**Should the control starter levers be left in starting position «A» in fig. 23) by riding, there would be irregular carburation and increased fuel consumption and even worse, there could be the possibility of seizures because of too much petrol going into the cylinders.**

*Do not forget that if the engine is in gear, the neutral indicator light (orange) is not lit; to start the engine in such conditions could be very dangerous, unless the clutch is kept fully disengaged, as the motorcycle itself may start off.*

### Starting a hot engine

In this case it is not necessary to set the starter control levers on the carburetors in starting position («A» in fig. 23) as this would richen the carburation too much.

## 20 On the way

To change to another gear close the throttle control, pull in completely the clutch lever and shift into the new gear; release gently the clutch lever and open the throttle control at the same time. The gearshift pedal has to be firmly actuated and foot accompanied.

When shifting down to a lower gear, gradually operate brakes and throttle control not to cause the engine to go over revs when releasing the clutch lever.

### Stopping the motorcycle

Close the throttle control and simultaneously operate both the brake control levers, the clutch lever will be pulled in when the motorcycle comes almost to stopping.

This manoeuvre has to be very co-ordinately carried out not to let the motorcycle going beyond control.

To normally reduce speed, use the engine braking power by correctly gearshifting and paying

attention that the engine does not go over revs. On wet or slippery roads, the brakes, especially the front one, have to be carefully operated.

To stop the engine turn the ignition key to position «0» see fig. 5.

**When the engine is stopped remember to close the taps by turning them to position «C» in fig. 10.**

### Parking

By parking by night on insufficiently lighted roads, it is necessary to let the rear light on, by turning the ignition key to position «1» see fig. 5 and the light switch to position «2».

To lock the steering with the key in position «1» see fig. 5 turn the handlebar completely left or right then take off the key from the switch.

### Running in

During the first 1600 kms (1000 miles) a new or overhauled motorcycle has to be used very care-

fully; as efficiency, performance and life of the engine are largely dependant on how the motor-cycle is run in.

The engine should never be allowed to reach a

high number of revolutions before having a chance to warm up sufficiently.

Never exceed the following speeds and do not force the engine long time.

### Running in speeds

Distance	Max. permissible speeds km/h (miles/h)				
	low gear	2nd gear	3rd gear	4th gear	5th gear
Up to 800 km (500 miles)	45 (28)	65 (40)	85 (53)	100 (62)	115 (72)
From 800 up to 1600 km 500 1000 miles	55 (34,5)	80 (50)	105 (65)	120 (75)	140 (87,5)
From 1600 up to 3000 km 1000 1800 miles	Increase gradually the speed up to the max. permissible limits.				

#### After the first 500 km (300 miles)

Change the engine oil.

Tighten all nuts and bolts.

Check, tighten spokes.

If necessary adjust valve rocker clearance.

Check contact breaker points.

#### Every 500 km (300 miles)

Check oil level; correct level is nearly at the maximum mark (see the marks on the oil filler cap dipstick).

## 22 MAINTENANCE

### Cleaning: fuel tank, fuel taps, filters and fuel lines

Every 10000 km (6000 miles) or so, or any time fuel flow to the carburetors is not regular, it is necessary to clean the fuel tank, the fuel taps the filters and the fuel lines.

The tap filters and ducts, the filters on the carburetors and the fuel lines are to be cleaned in petrol and then to be blown with compressed air.

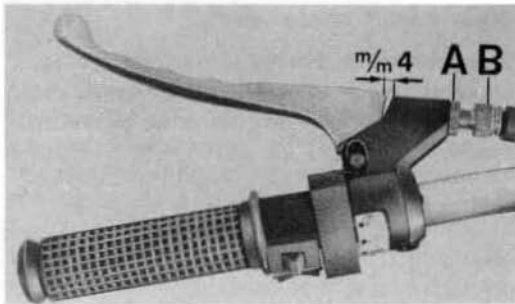

### Adjusting the clutch lever

If the free play at the handlebar (fig. 12) is more or less than mm 4, slacken thumb screw «B» and screw in or out adjuster «A» to obtain the correct play.

This adjustment can also be carried out by slackening nuts «C» and acting on adjuster «D» that is located right on the gear box.

12

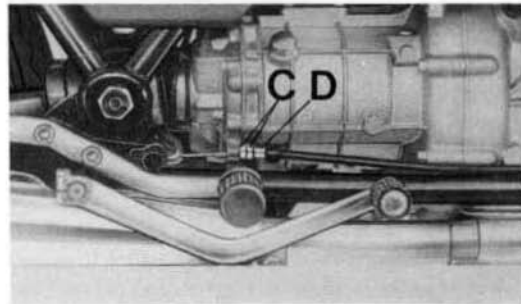



## Front brake

For a good working of the front brake (fig. 13) these directions are to be followed:

- periodically check the fluid level (it has to be nearly at the gaiter «E» located in the fluid reservoir on the handlebar); it has never to be lower than 8 mm under maximum level;
- periodically fill up the fluid reservoir «A» (if necessary) after loosening the cap «F»; take the fluid from an original container which must only be opened when using the fluid;
- completely renew the brake fluid every 15000 km (9000 miles) or at least once a year.

The fluid ducts have to be always full and without air; a long and elastic movement of the control lever «B» evidences the presence of air inside the ducts.

Fluid to be used «Agip F.1 brake fluid».  
Use only fresh fluid in case of washing.

No alcohol is to be used for washing and no compressed air for drying up; use Trichloroethylene for metallic parts.

- check that the play between the float on the pump and the end of the control lever on the handlebar is  $0,1 \div 0,3$  mm; otherwise get it by acting on the adjuster «G»;
- every 5000 km (3000 miles) check the wearing of the brake pads:
  - new pad thick. mm 9;
  - wear limit thick. mm 6 a.

If thick. is under the wear limit, it is necessary to replace the pads. After this operation has been carried out, do not drain the air but only operate the control lever on the handlebar «B» several times until the small pistons of the pliers reach their normal position; pad distance from the disc a. 0,2 mm.

By the replacement of the pads check the condition of the fluid ducts, should they be damaged, replace them immediately;

24

the brake disc must be accurately clean, without oil, fat or other dirt and must not show any deep rifling.

In case of replacement or overhauling of the brake disc, it is necessary to check the fluttering of the same. This checking is carried out by means of a proper gauge that must never read more than 0,2 mm.

Should the fluttering be higher, carefully check the mounting of the disc on the hub and the play of the hub bearings.

Connection torque between disc and hub is kg/cmq  $2,2 \div 2,4$ .

*Pad replacement and disc checking are best carried out by officially appointed Moto Guzzi dealers.*

## Draining the air from the braking unit

This operation is required when the movement of the control lever on the handlebar is long and elastic because of the presence of air inside the braking circuit.

Operations are as follows:

13

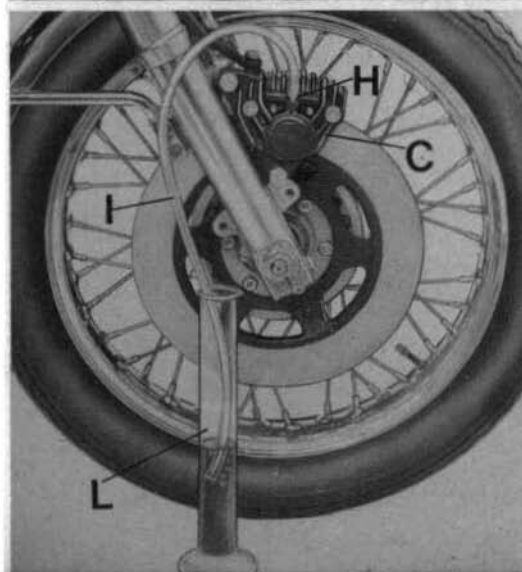
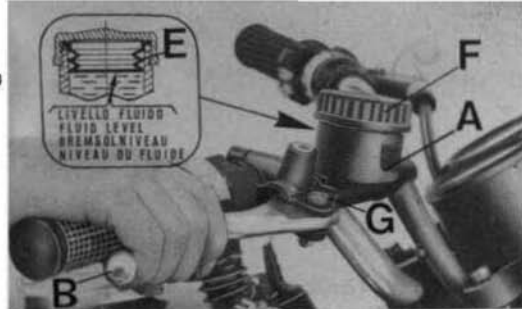

- turn the handlebar until the fluid reservoir «A» reaches the horizontal position;
- if necessary, fill up the fluid reservoir «A» (take care that during the air draining the fluid does not go 8 mm lower than the maximum level);
- by the air draining act on a pliers-half «C» at a time:
  - a) take out the rubber cover, then fit a transparent flexible duct «I» on the drain plug «H»; the other end of this duct will be plunged into a transparent container «L» partially filled up with fluid of the same type;
  - b) loosen the drain plug «H»;
  - c) completely operate several times the brake control lever «B» on the handlebar, release it slowly and wait for a few seconds before operating it again. Repeat this operation until the duct plunged into the transparent container emits airless fluid;
  - d) keep the control lever «B» completely drawn and lock the drain plug «H» then take off the duct «I» and mount the rubber cover.

If the air draining has been correctly carried out, a direct and efficient working of the fluid will be realized immediately after the initial idle movement of the lever «B»; otherwise repeat the air draining.

## Adjustment of the rear brake control pedal

This adjustment is carried out by acting on the adjuster «A» (fig. 14). Excessive play is corrected by screwing this adjuster.

The lever is correctly adjusted when there is a  $20 \div 25$  mm, play before the linings contact the drum.

## Adjustment of the rear suspension

The external springs of the rear suspension can be adjusted on five positions by acting on the levers «A».

26

Starting from position «I» turn the levers «A» (see the arrow in fig. 15) into positions «II», «III», «IV», «V».

In case of faulty damper operation, have them checked by our dealers.

*Do not forget that the two springs have to be adjusted at the same positions, to ensure a good stability of the motorcycle.*

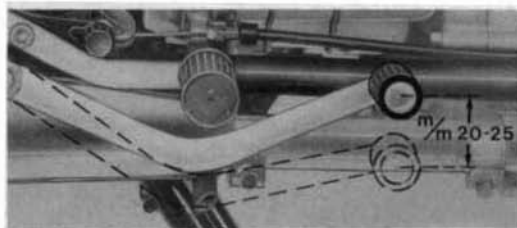

14



## Adjusting the steering

For a safe riding, steering has to be so adjusted (fig. 16) to allow a free movement of the handlebar but without excessive play.

To correctly adjust steering operate as follows:

- slacken the steering head fixing bolt «A» loosen the nut «B» and screw in or out the adju-

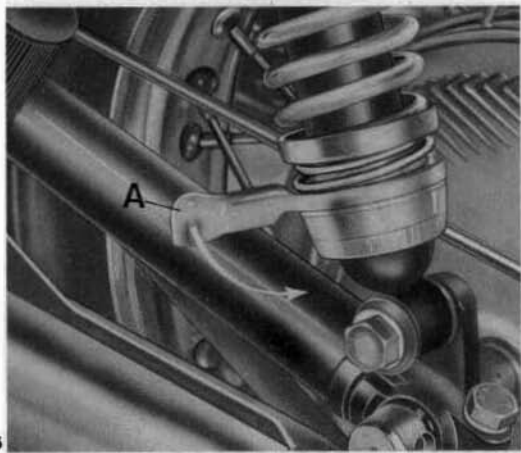

15

ster «C» to take up excessive play. After this adjustment has been made, lock nut «B» and the steering head fixing bolt «A».

*It is recommended to have this operation carried out by our dealers.*

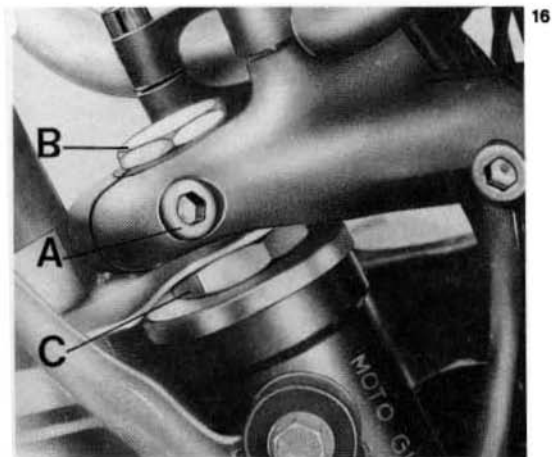

## 28 REMOVAL OF WHEELS

### Front wheel

The front wheel (fig. 17) is removed as follows:

- unscrew the wheel spindle nut «A» on the right fork cover;
- slacken the screws securing the fork covers

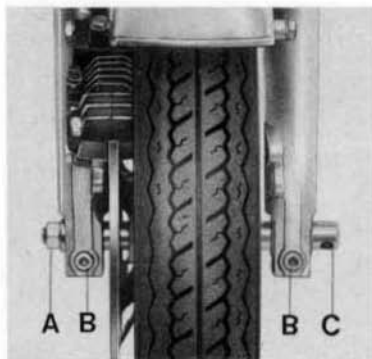

17

to the wheel spindle «B» and slide out the wheel spindle «C»;

- lift the motorcycle so to slide the braking disc out of its pliers fixed on the right fork cover.

To re-assemble the wheel operate viceversa, do

not forget to check the play between the brake pads and the brake disc (see the chapter **Maintenance** «Front brake»).

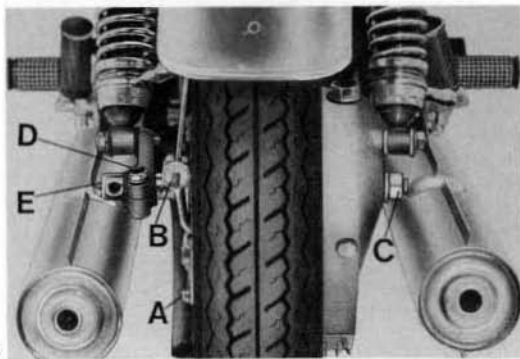

18

## Rear wheel

To remove the rear wheel (fig. 18) from the rear drive and from the arm of the rear suspension proceed as follows:

- slacken the locknut «B» on the drag link of the brake block lever;
- unscrew nut «C» which secures the wheel spindle to the rear drive box;
- unscrew nut «A» which secures the anchoring bracket to the brake block;
- unscrew nut «D» which secures the rear suspension arm to the wheel spindle, then slide the spindle «E» out of rear drive box, wheel hub and rear suspension arm;
- shift the wheel to the left to free the driving gear from the sleeve in the drive box;
- lean the motorcycle to the left and remove the wheel.

To re-assemble the wheel operate viceversa; **remember to fix the anchoring bracket to the brake block.**

## Adjusting the spokes

Check that all spokes are tightened and the wheel is not out of centre by proceeding as follows:

- get the wheel turn and check its centering, if necessary act on the right or left spokes until the wheel turns properly. This checking has to be carried out after the first 500 km (300 miles) and later on every 1500 km (900 miles) or so.

## Wheel balance

To improve stability and decrease vibrations at high speeds the wheels have to be kept balanced.

Operations are as follows:

- after removing the wheel and checking that all spokes are tight and the wheel centering, suspend it on a fork;
- spin the wheel lightly several times and see if it stops always in various positions, thus indicating a correct balance;

- If one side of the wheel always stops at the bottom, put a balance weight on a spoke opposite that side;
- repeat this operation until the wheel is correctly balanced then fix the balance weights to the spokes by means of pliers.

Balance weights are available from our dealers in 15, 20, 30 grams.

Normally, an imbalance of less than 15 grams does not affect the motorcycle stability.



## LUBRICATION AND MAINTENANCE CHART

(fig. 19)

Monthly every 3000 km  
(2000 miles)

1 Check electrolyte level in battery (see chapter **Electrical Equipment** «Battery»).

5 Check all tighten spokes and wheel centering (see chapter **Removal of wheels** «Adjusting the spokes»).

6 Check rocker clearance (see chapter **Valve gearing** «Tappet clearance»).

Periodically

2 Check tyre pressure (see chapter **Main features** pag. 7).

Every 500 km (300 miles)

7 Check oil level in the crankcase (see chapter **Lubrications**).

After the first 500 km  
(300 miles)

3 Replace the crankcase oil (see chapter **Lubrications**).

Every 1500 km (900 miles)

8 Check all tighten spokes and centering of wheels (see chapter **Removal of wheels** «Adjusting the spokes»).

4 Tighten all nuts and bolts.

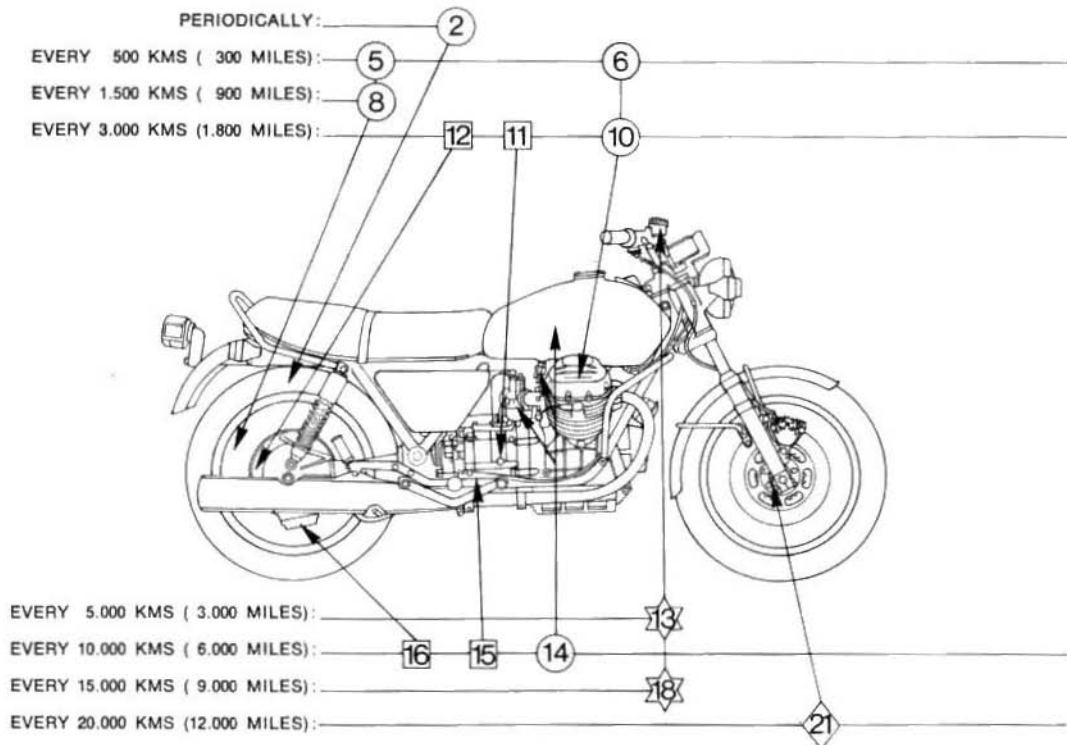

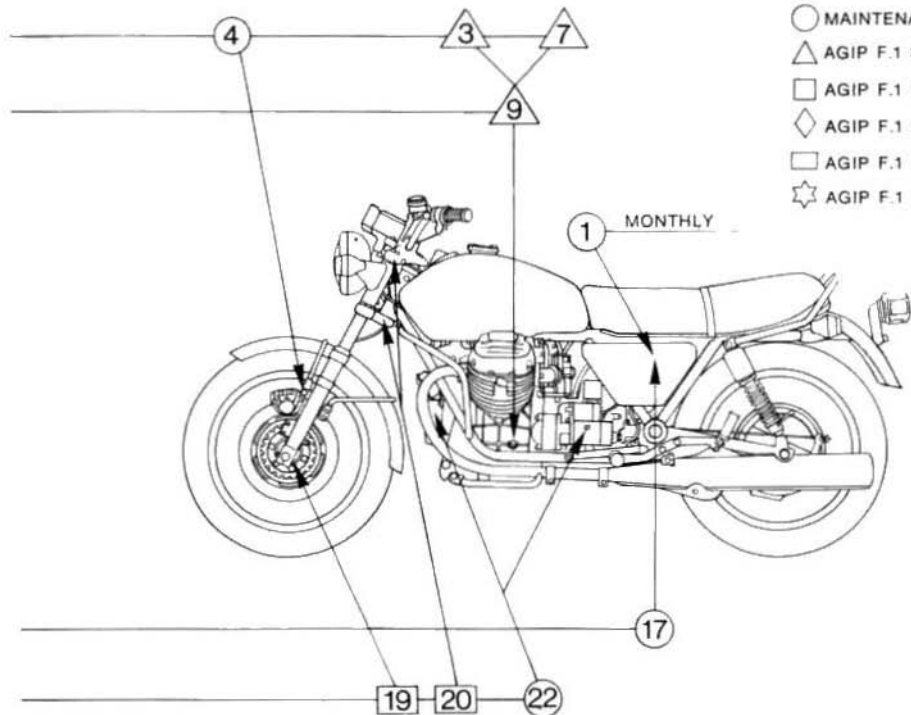

- MAINTENANCE
- △ AGIP F.1 SUPERMOTOROIL SAE 20 W/50
- AGIP F.1 ROTRA MP SAE 90
- ◇ AGIP F.1 ATF DEXRON
- AGIP F.1 GREASE 30
- ☆ AGIP F.1 BRAKE FLUID

## 34 Every 3000 km (2000 miles)

- 9 Replace oil in the engine crankcase (see chapter **Lubrications**).
- 10 Check rocker clearance (see chapter **Valve gearing** «Tappet clearance»).
- 11 Check the oil level in the gear box (see chapter **Lubrications**).
- 12 Check oil level in the rear drive box (see chapter **Lubrications**).

## Every 5000 km (3000 miles)

- 13 Check the fluid level in the brake fluid reservoir (see chapter **Maintenance** «Front brake»).

## Every 10000 km (6000 miles)

- 14 Clean the fuel tank, the fuel taps, the filters and the fuel lines (see chapter **Maintenance** «Cleaning the fuel tank, filters, taps and fuel lines»).

- 15 Replace the oil in the gear box (see chapter **Lubrications**).

- 16 Replace the oil in the rear drive box (see chapter **Lubrications**).

- 17 Clean and smear all battery connections (see chapter **Electrical equipment** «Battery»).

## Every 15000 km (9000 miles)

- 18 Replace the brake fluid of the front brake (see chapter **Maintenance** «Front brake»).

## After the first 20000 km (12000 miles)

All checkings hereunder described must be carried out by our dealers:

- 19 Check that there is sufficient grease in the wheel bearings «Agip F.1 Grease 30» or equivalent.

**20** Check that there is sufficient grease in the steering bearings «Agip F.1 Grease 30».

**21** Replace the oil in the fork covers (use «Agip F.1 ATF Dexron») quantity l. 0,020 (half a glass a.) per cover.

**22** Clean starter motor and generator commutators using a clean rag slightly moistened with petrol.

## 36 LUBRICATIONS

### Engine lubrication

(fig. 20)

#### Engine oil

Using the oil filler dipstick «A» check the sump level every 500 km (300 miles).

Correct oil level is nearly at the maximum mark. Should the level be lower than recommended, fill up with oil of the same type and features.

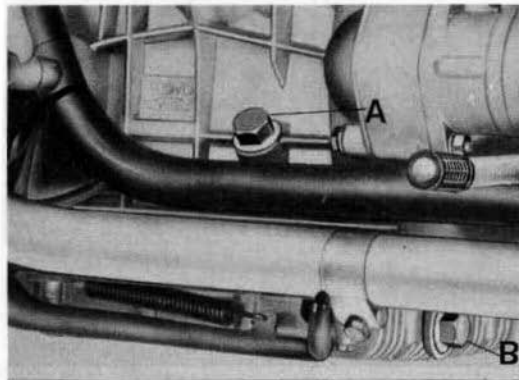

20

### Replacing the engine oil

After the first  $300 \div 500$  km ( $200 \div 300$  miles) a. and later on every 3000 km (2000 miles) or so, change the engine oil.

The oil has to be replaced when the engine is warm. Remember to allow all the old oil to drain before introducing fresh oil.

«A» oil filler cap.

«B» oil drain plug.

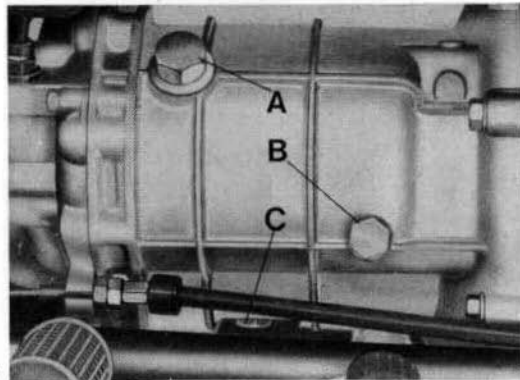

21

Quantity required: l. 3,5 of oil «Agip F.1 Super-motoroil SAE 20 W/50».

## Gear box

(fig. 21)

### Checking the oil level

Every 3000 km (2000 miles) check that the oil level is nearly at the inspection hole «B». If this level is not correct, fill up with oil of the same type and features.

### Changing the oil

Every 10000 km (6000 miles) or so, change the oil in the gear box.

This operation should be carried out a short time after a ride when the oil is still warm and easily drained.

Remember to drain all the old oil before introducing fresh oil.

- «A» oil filler cap.
- «B» level inspection plug.
- «C» oil drain plug.

Quantity required: l. 0,750 of oil «Agip F.1 Rotra MP SAE 90».

37

## Rear drive box

(fig. 22)

### Checking the oil level

Every 3000 km (2000 miles) check that the oil level is nearly at the inspection hole «A». If the level is not correct, fill up with oil of the same type and features.

22

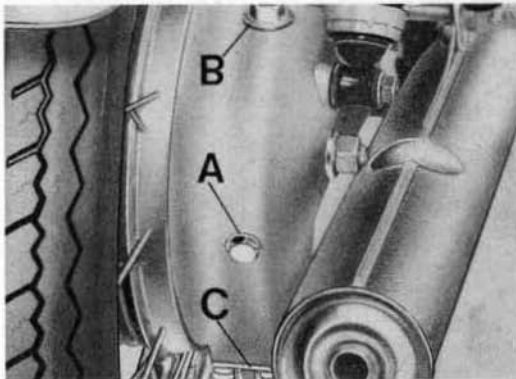

## 38 Changing the oil

Every 10000 km (6000 miles) change the oil in the rear drive box.

This operation should be carried out a short time after a ride when the oil is still warm and easily drained.

Remember to drain all the old oil before introducing fresh oil.

«A» inspection level plug.

«B» oil filler cap.

«C» oil drain plug.

Quantity required:

l. 0,340 of oil «Agip F.1 Rotra MP SAE 90»

l. 0,020 of oil «Molykote A».

## Front fork, steering bearings, wheels and rear suspension

For these lubrications it is suggested to apply to our dealers.



## CARBURATION

### Carburetors

(fig. 23)

N. 2 Dell'Orto Carburetors «VHB 30 CD» (right)  
«VHB 30 CS» (left).

Double controls:

- throttle control grip, right on the handlebar;
- starter control levers, left on the left carburetor and right on the right carburetor.

#### Standard carburetor setting

Choke	∅ mm 30
Throttle	40
Atomizer	265
Main jet	142
Idling jet	50
Starter jet	80
Needle	V 9 (2nd notch)
Float	10 grams

Idling screw: open 2 to 2½ turns for the left carburetor - open 2¼ to 2¾ turns for the right carburetor.

23

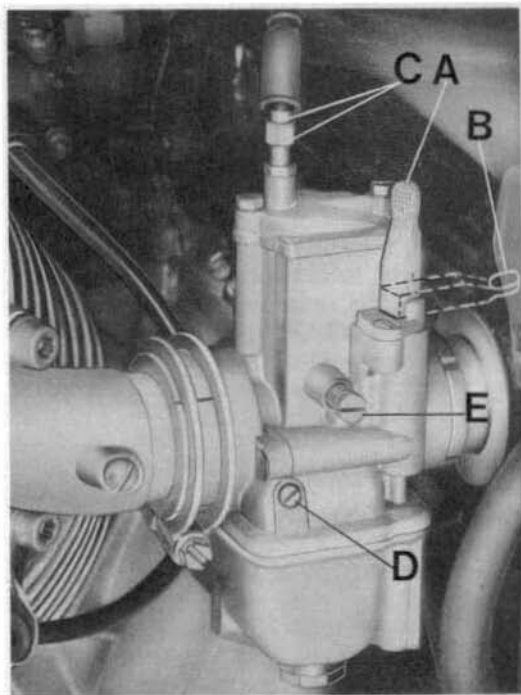

## 40 Adjusting the carburation (fig. 23)

The carburation is adjusted on a hot engine after the inlet and exhaust tappets have been set at a correct distance.

Proceed as follows:

1 With the carburetor rubber inlet manifold removed, check that both gas valves open at the same time. This is done by turning the throttle grip and at the same time feeling with your fingers on the carburetor slides if these open simultaneously by the same amount.

Should one valve open before the other, correct by setting screw «C» in fig. 23 in the position where by turning the throttle grip both valves open simultaneously.

2 Adjust the idling speed by acting on the screw «D». Screwing this in reduces the fuel flow and viceversa increases it. To adjust, tighten the screw then undo it 2 to 2½ turns for the left carburetor and 2¼ to 2¾ turns for the right carburetor.

With the engine revolving at about 1000 ÷ 1200 r.p.m. disconnect the plug lead of any one of the cylinders and lightly turn screw «D» of the

opposite carburetor to the position which will give the best idling speed, i.e. until the engine revs increase slightly.

The same operation should be repeated on the carburetor of the opposite cylinder. This will give a correct idling speed and prevent engine popping.

### Min. engine speed

Due to the constructive characteristics of this engine, the idling speed adjustment should never be made with the engine running at less than 1000 ÷ 1200 r.p.m.

A good idling speed is obtained as follows:

3 Disconnect the right cylinder plug lead, start the engine and ensure that it stops after firing 4-5 strokes; if it dies out earlier or later adjust idling screw «E» until the engine stops after firing 4 or 5 times.

Repeat the same operation on the right cylinder with the left cylinder plug lead disconnected.

If the right cylinder is normal, the engine should stop after firing 4-5 strokes. If not, screw «E»

should be similarly adjusted to the position where the engine does so. Then reconnect the left cylinder plug lead.

4 Reconnect the carburetor inlet rubber manifold.

*For these adjustments it is recommended to apply to our dealers.*

## 42 VALVE GEARING

### Tappet clearance

(fig. 24)

Every 3000 km (2000 miles) or any time valve operation is too noisy, tappet clearance should be checked.

This adjustment is made on a cold engine with the piston at TDC exactly at the end of its compression stroke.

After removing the head cover, operate as follows:

- 1 slacken nut «A»;
- 2 screw in or out the adjuster screw «B» until the following clearances are obtained:

- inlet valve mm 0,22;
- exhaust valve mm 0,22.

Use a feeler gauge «C» to check this clearance. When this is excessive, there will be noisy valve operation; if it is less, the valves may not close fully causing inconveniences such as:

- compression loss;
- engine overheating, etc.

On a new engine, this adjustment must be made after the first 500 km (300 miles).

### Checking of valve timing

A job of this kind is best done by officially appointed Moto Guzzi dealers.

24

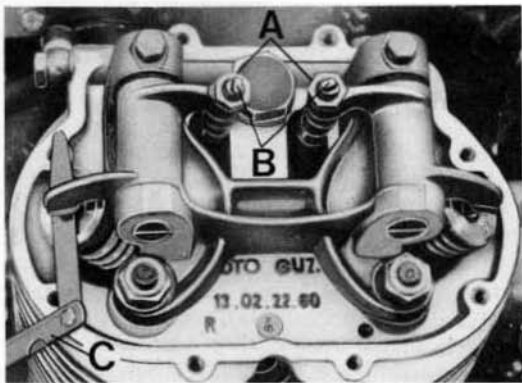

## IGNITION

### Checking and adjustment of double contact breaker (fig. 25)

#### Maintenance

Every 3000 km (2000 miles)

Lightly moisten with some engine oil drops the cam felt pad.

#### Inspection

- remove the contact breaker cover by undoing the securing screws;
- if contacts «A» and «B» are dirty and greasy, clean them with a petrol moistened rag. If they are in any way damaged replace them;
- check points gap of breaker «A» (right cylinder - red cable) and breaker «B» (left cylinder - green cable) which should be between mm 0,42 ÷ 0,48. If this distance is higher or lower, the points have to be adjusted.

#### Adjustment of contact points

##### Contact points «A» - right points

Bring cam «I» to maximum lift, loosen screws «C» and «D» and move plate «E» by acting on nocht «F».

25

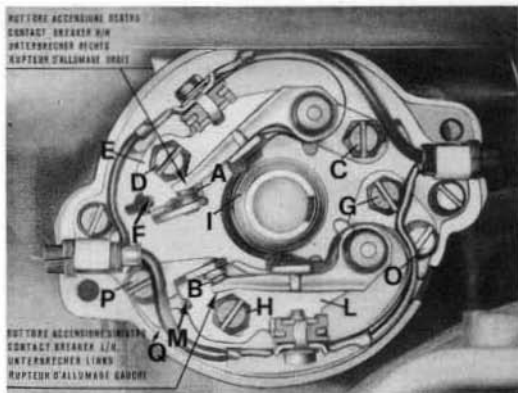

44 After setting the correct distance, lock screws «C» and «D».

**Contact points «B» - left cylinder**

Bring cam «I» to maximum lift, loosen screws «G» and «H» and move plate «L» by acting on notch «M».

After setting the correct distance, lock screws «G» and «H».

*When adjusting the contact points ignition timing should be checked as well (see chapter «Checking of ignition timing»).*

## Checking and adjustment of ignition timing «fixed advance»

(fig. 26)

### Checking

- remove the rubber cap which seals the inspection hole on the right side of the gear box;
- to find the exact moment when the points «A» and «B» in fig. 25 start separating, it is advisable to use a suitable timing light device mounted in between the breaker feed clamp and the ground.

### Timing the right cylinder (see fig. 26)

- rotate the flywheel anticlockwise until the piston is at the end of its compression stroke (both valves closed). In this position, mark «D» on the flywheel (TDC of right cylinder) should coincide with mark «1» on the rim of the inspection hole;
- rotate the flywheel clockwise until the flywheel mark «2» (fixed advance) is in perfect coincidence with mark «1» on the rim of the inspection hole. In this position the ignition fixed advance mark «2» is 8° from TDC («D») that's at

the beginning of the points separation («A» in fig. 25).

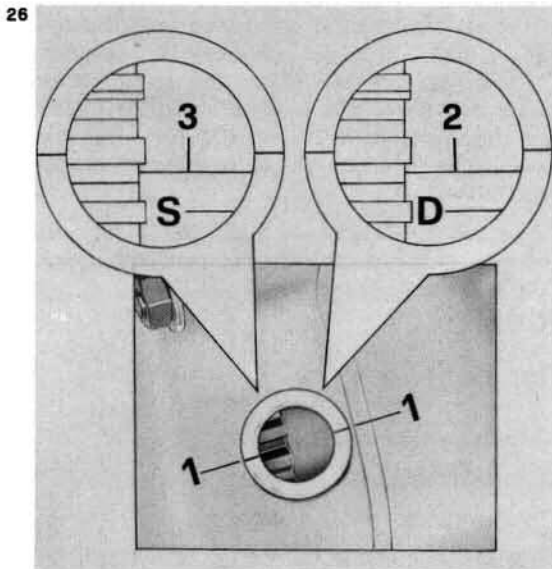

## 46 Timing the left cylinder (see fig. 26)

- rotate the flywheel anticlockwise until the piston is at the end of its compression stroke (both valves closed). In this position, mark «S» on the flywheel (TDC of left cylinder) should coincide with mark «1» on the rim of the inspection hole;
- rotate the flywheel clockwise until the flywheel mark «3» (fixed advance) is in perfect coincidence with mark «1» on the rim of the inspection hole. In this position the ignition fixed advance mark «3» is 8° from TDC («S») that's at the beginning of the points separation («B» in fig. 25).

*If the points («A» and «B» in fig. 25) do not start opening in the above positions, the ignition timing needs adjustment.*

## Ignition data

Initial advance (fixed)	8°
Automatic advance	26°
Total advance	34°

*This checking is best carried out by our dealers.*

## Spark plugs

This motorcycle fits spark plugs with thermal degree 240 (points gap 0,6 mm).

The spark plugs are best cleaned with petrol and a wire brush using a needle for the inner part. In re-fitting the plugs ensure they are properly started by hand for a few turns completing the operation by means of the plug wrench in the tool kit. If not properly started the cylinder head thread may get stripped.

For all events, the plugs have to be replaced every 10000 km a. even if they still appear to be in good conditions.



## ELECTRICAL EQUIPMENT

(diagram fig. 27)

### Battery

The 12 V battery is centrally mounted and has a capacity of 32 Ah. It is charged directly by the generator.

Every month or after every 3000 km (2000 miles) check the electrolyte level and eventually top up in each cell, the level is correct when the electrolyte tops the plate separator by 6 mm.

Always top up with distilled water, chemically pure, and never add acid.

Distilled water has to be added to a cold battery after it has not been used for at least 6 hours. Make sure that no electrolyte flows over the top of the battery which must always be in perfect dry conditions.

Every 10000 km (6000 miles) check that all battery connections are well tight and clean. Smear them with neuter vaseline to prevent oxidation.

A charged battery has a hydrometer reading of 1,28 sp.g. and a discharged battery of about 1,16 sp.g.

*To put a new battery in service apply to our dealers.*

**WIRING DIAGRAM - LEGEND**

(see fig. 27)

- A** - Generator
- B** - Rectifier
- C** - Regulator
- D** - Battery
- E** - Starter motor
- F** - Starter motor relay
- G** - Horn
- H** - Flashing light relay
- I** - Hydrostop
- L** - Rear stop switch
- M** - Terminal block with fuses
- N** - Flasher unit
- O** - Asymmetric light
- P** - Left turn signal, rear
- Q** - Right turn signal, rear
- R** - Left turn signal, front
- S** - Right turn signal, front
- T** - Engine starter and stop switch
- U** - Control device, turn signals, horn, flashing light
- V** - Light switch; dimmer, parking light
- AA** - Mile counter
- BB** - Rev. counter
- CC** - General commutator
- DD** - H.T. coil
- EE** - Oil light switch

- FF** - Neutral light switch
- GG** - Number plate and stop light
- HH** - Instrument panel
- LL** - Oil pressure light (red)
- MM** - Neutral light (orange)
- NN** - Battery light (red)
- OO** - High beam light (red)
- PP** - Connectors
- QQ** - 4-way connector «AMP»
- RR** - Spark plugs
- SS** - 15-way connector «MOLEX»
- TT** - 3-way connector «MOLEX»
- UU** - 12-way connector «MOLEX»
- X** - Low beam
- Y** - High beam
- Z** - Contact breaker

**Fuses**

- F1 - 15 A** - Horn, stop, signals relay
- F2 - 15 A** - Starter relay, flasher unit
- F3 - 15 A** - Head light, lights LL; MM; NN
- F4 - 15 A** - Parking light, light OO
- F5 - 15 A** - Reserve
- F6 - 15 A** - Reserve



SEIMM MOTO GUZZI S.p.A. Mandello del Lario

Reg. imprese N. 2220 Lecco



PREMIER

MOTOR CORPORATION

HARBORCK HEIGHTS, NEW JERSEY 07634