

Moto Guzzi V1000 G5 Owner's Manual

Front and Back Cover

**The illustrations and descriptions in this booklet are indicative only and the manufacturer reserves itself the right to introduce any modification it may deem necessary for better performance or for constructive or commercial reasons without prior notice.**

SEIMM MOTO GUZZI - Technical publications - Code n. 18 90 00 01 - 1000 - 3/78  
Printed in Italy - Mariani - Almè (Bergamo)

*First of all we wish to thank you for choosing a Moto Guzzi motorcycle. By following the instructions outlined in this booklet you will ensure a long and troublefree life for your machine.*

*Before riding, please read carefully these instructions in order that you may know your motorcycle features and how to operate it safely.*

*All major checking and overhauling jobs are best carried out by our dealers who have the necessary facilities and know how to competently repair your byke.*

*Repair and/or adjustments made by others than Moto Guzzi dealers during the warranty period could invalidate the warranty right.*



## INDEX

- 4 Main features
- 10 Controls and accessories
- 12 Identification data
- 13 Instruments and controls
- 21 Riding instructions
- 23 Running in
- 25 Maintenance and adjustments
- 32 Removal of wheels
- 35 Lubrication and maintenance
- 37 Lubrications
- 41 Carburation
- 44 Valve gearing
- 45 Ignition
- 48 Electrical equipment
- 52 Wiring diagram

## 4 MAIN FEATURES

<b>Engine</b>	Twin cylinder, 4-stroke Cylinder disposition «V» 90° Bore 88 mm Stroke 78 mm Displacement 948,8 cc Compression ratio 9.2 to 1 Max torque 8.6 kgm at 5200 rpm
<b>Valve gearing</b>	O.H.V., push rod operated.
<b>Carburation</b>	N. 2 Dell'Orto carburetors VHB 30 CD (right), VHB 30 CS (left).
<b>Lubrication</b>	Pressure, by gear pump. Wire gauze and cartridge filters in oil sump. Normal lubrication pressure: 3.8 ÷ 4.2 kg/sqcm (54-60 p.s.i.). Controlled by pressure relief valve.

<b>Generator-Alternator</b>	Front, on the crankshaft (14 V - 20 A).	5
<b>Ignition</b>	By battery, with double contact breaker and automatic advance. Ignition data: — Initial advance (fixed) 0° ÷ 2° — Automatic advance 31° — Full advance (f. + a.) 31° ÷ 33° — Contact breaker gap: 0.37 ÷ 0.43 mm (.014-.016") — Spark plugs: Marelli CW 7 LP Bosch W 225 T2 Champion N 9 Y AC - 44 XL Lodge HLNY — Plug points gap: 0.6 mm (.023") — 2 ignition coils fitted on the frame on top of the engine.	
<b>Starting</b>	Electric starter (12 V - 0.7 KW) with electromagnetic ratchet control. Ring gear bolted on the flywheel. Starter button (START) on R/H of handlebar.	

## Transmission

<b>Clutch</b>	Dry type, twin driven plates. Hand controlled by lever on the left side of handlebar.
<b>Primary drive</b>	By gears. Ratio: 1.235 to 1 ( $Z = 17/21$ ).
<b>Gear box</b>	5 speeds, frontal engagement, constant mesh gears. Cush drive incorporated. Pedal operated on L/H of vehicle. Gear ratios: Low gear = 1 to 2 ( $Z = 14/28$ ) 2nd gear = 1 to 1.388 ( $Z = 18/25$ ) 3rd gear = 1 to 1.047 ( $Z = 21/22$ ) 4th gear = 1 to 0.869 ( $Z = 23/20$ ) High gear = 1 to 0.750 ( $Z = 28/21$ )
<b>Secondary drive</b>	By cardan shaft. Bevel gear set. Ratio: 1 to 4.714 ( $Z = 7/33$ ). Overall ratios (engine-wheel): Low gear = 1 to 11.643 2nd gear = 1 to 8.080 3rd gear = 1 to 6.095 4th gear = 1 to 5.059 High gear = 1 to 4.366

## Frame

Duplex cradle, tubular structure.

7

### Wheels

Front and rear: spoked rims WM 3/2.15 - 18".

### Tires

Front: 100/90 H 18 (MT 18).  
Rear: 110/90 H 18 (MT 18).

### Brakes

#### Front wheel

Twin disc brakes, two independent controls with hydraulic lines and twin cylinder calipers.

#### Controls:

Right front brake: hand controlled by lever connected to master cylinder on R/H side of handlebar.

Left front brake: pedal controlled at same time as rear brake.

— Disc  $\varnothing$  300 mm (11.8")

— Cylinder  $\varnothing$  38 mm (1.49")

— Master cylinder for hand controlled R/H brake: 12.7 mm (.5").

*Rear wheel*

Disc brake, controlled by hand lever and pedal on R/H side of vehicle, hydraulic hose and 2-cylinder caliper.

Rear brake and front brake are interconnected by an hydraulic circuit.

- Disc  $\varnothing$  242 mm (9.5")
- Cylinder  $\varnothing$  38 mm (1.49")
- Master cylinder  $\varnothing$  15.875 mm (.624").

**Dimensions and weights**

Wheelbase	1.470 mt (58")
Length	2.200 mt (86.5")
Width	0.850 mt (33")
Height	1.100 mt (46")
Min. ground clearance	0.150 mt (6")
Weight abt	220 kg (485 lbs).

**Performances**

Top speed, solo riding: abt 190 km (120 mph).  
Fuel consumption: abt 5.8 l x 100 km (approx. 35 mpg).

**Fuel and oil capacities**

Group or part	Quantity	Recommendation
Fuel tank	24 l (6.6 US gls)	Gasoline 98/100 NO-RM
Reserve (warned by light)	4 l (abt 1 US gl)	
Oil sump	3 l (abt 3 qts)	Oil «Agip Sint 2000 SAE 10/50»
Gear box	0.750 l (abt 20 oz)	Oil «Agip F.1 Rotra MP SAE 90»
Rear drive box (bevel gears)	0.250 l (abt 9 oz) of which 0.230 (8 oz) 0.020 (3/4 oz)	Oil «Agip F.1 Rotra MP SAE 90» Oil «Agip Rocol ASO/R»
Front fork (each leg)	0.080 l (abt 2 oz)	Fluid «Agip F.1 ATF Dexron»
Braking circuits (front and rear)		Fluid «Agip F.1 Brake fluid SAE J 1703»

## 10 CONTROLS AND ACCESSORIES

(fig. 2)

- |  |   |
|--|---|
| 1 Caliper, right front brake.                        | 16 Saddlebag.   |
| 2 Front turn signal.                                 | 17 Caliper, left front brake.                             |
| 3 Instrument panel with warning lights.              | 18 Headlight.   |
| 4 Speedometer.                                       | 19 Clutch control lever.                                  |
| 5 Reservoir (master cylinder) for right front brake. | 20 Front bumper.  |
| 6 Right front brake control lever.                   | 21 Buttons controlling: horn, flashers, and turn signals. |
| 7 Engine start and stop button.                      | 22 Light switch.  |
| 8 Throttle control grip.                             | 23 Lock for filler cap cover opening.                     |
| 9 Ignition key.                                      | 24 Starter control lever on carburetors.                  |
| 10 Rev-counter.                                      | 25 Gear shift pedal.                                      |
| 11 Left front and rear brake control pedal.          | 26 Rear brake caliper.                                    |
| 12 Footrest.   | 27 Rear turn signal lamp.                                 |
| 13 Master cylinder left front brake and rear brake.  |   |
| 14 Pillion footrest.                                 |   |
| 15 Rear bumper.                                      |   |

*«Right» or «left» in the text are for controls seen from the riding position.*

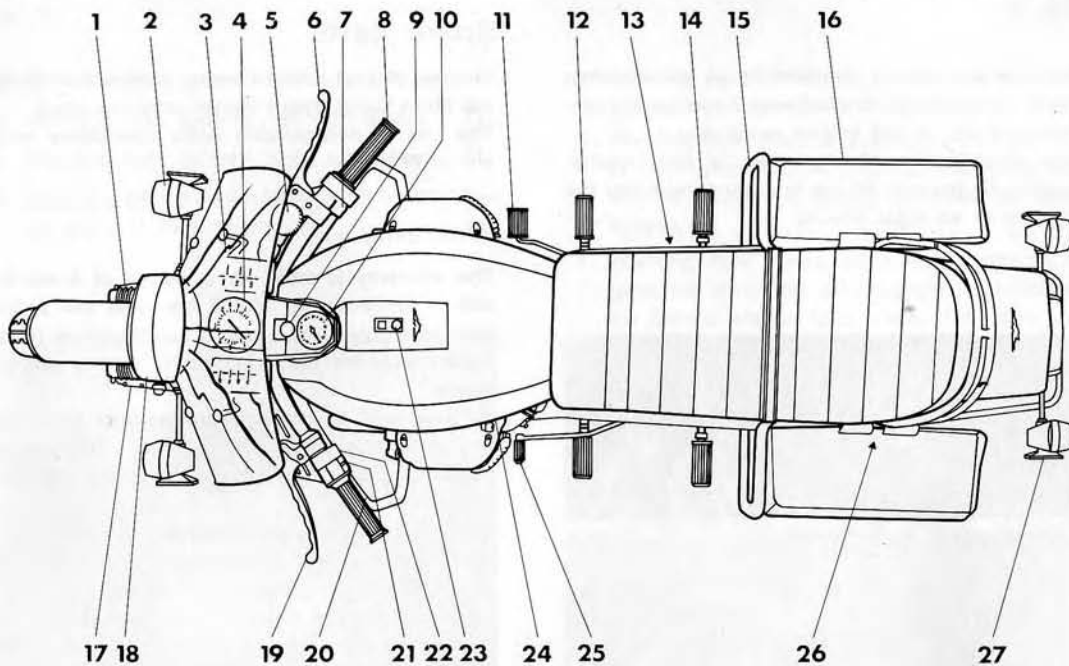

11

2



## 12 IDENTIFICATION DATA

(fig. 3)

Every motorcycle is identified by an identification plate on the frame downtube and one serial number stamped on the engine crankcase. The identification plate number is also mentioned in the motorcycle log-book and identifies the vehicle to all legal effects.

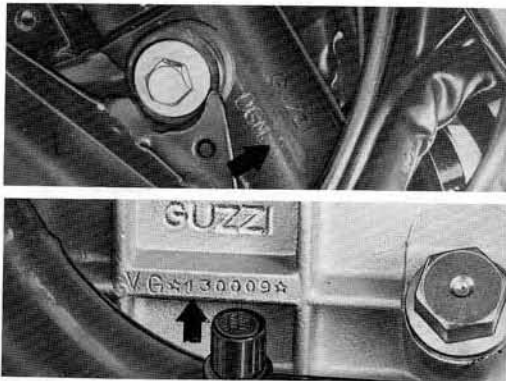

## Spare parts

In case of part replacements, ensure that «**original Moto Guzzi spare parts**» only are used.

**The use of non-genuine parts invalidates every warranty right.**

## Warranty

The warranty is valid for a period of 6 months with a limitation to 10.000 km from the selling date and expires in case of modifications to the motorcycle or participation to racing competitions.

Tires as well as parts or accessories which are not manufactured in the «Seimm - Moto Guzzi Factories», are not included in these warranty terms.

Each new motorcycle is supplied with a «coupon-book». It has to be carefully kept with all other circulation papers as it is the only document entitling the owner of the motorcycle to be recognized the warranty right by «Seimm - Moto Guzzi», in accordance with its general conditions of sale.

## INSTRUMENTS AND CONTROLS

(fig. 4)

- 1 Speedometer, km or miles counter.
- 2 Warning light (green), left turn signal.
- 3 Warning light (green), right turn signal.
- 4 Warning light (red for USA), high beam (blue for Europe), high beam.

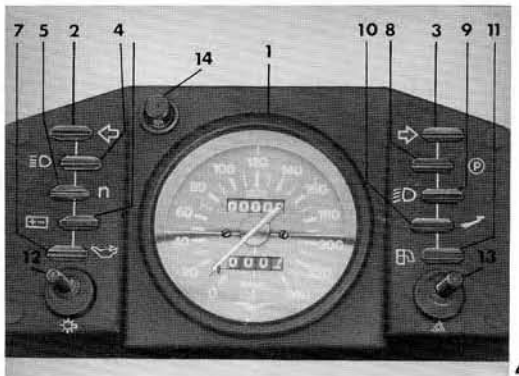

- 5 Warning light (orange). It is lit when the transmission (gearbox) is in neutral.
- 6 Warning light (red) indicating current delivery from generator. It must go out when the engine reaches a certain number of revolutions.
- 7 Warning light (red), oil pressure gauge. It goes out when the oil pressure is sufficient for normal engine lubrication. If it does not go out, this means the oil pressure is not correct. In such event, the engine has to be stopped immediately and all circuits have to be checked.
- 8 Warning light (green) indicating parking brakes engaged. This warning light flashes by turning the ignition key to position «2» (see fig. 5). If the side stand is not raised, the engine cannot be started.
- 9 Warning light (red for USA) indicating parking light and low beam on. Warning light (green for Europe) indicating town driving light and low beam on.

13



- 14 10 Warning light (red) indicating incorrect fluid level in front left and rear brake reservoir. When this warning light comes on, top up the fluid level and check the braking circuit has no leakages.
- 11 Warning light (red), fuel reserve. To use the reserve fuel, bring the tap lever on the right fuel tank in position «R» (fig. 10).
- 12 Courtesy light switch (available).
- 13 Switch, right and left rear emergency flashers.
- 14 Odometer or km counter reset.

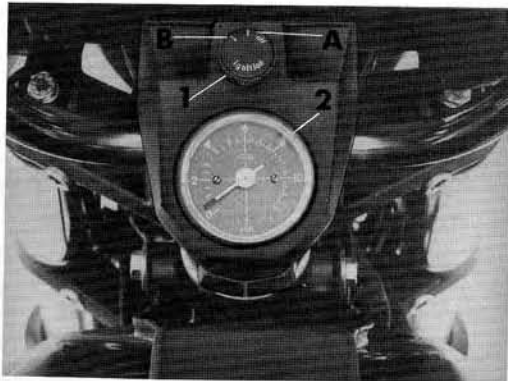

5

### Ignition key (fig. 5)

- 1 This key has 3 positions:
  - «OFF» In line with the mark on panel: machine at standstill, key removable.
  - «A» In line with the mark on panel (turned clockwise): machine ready to be started. All circuits on. Key not removable.
  - «B» In line with mark on panel (turned clockwise): machine at standstill. With switch «A» in fig. 6 in position «O» parking lights are on. Key removable.
- 2 Rev-counter.

### Light switch (fig. 6)

Are located on the left handlebar and have 4 positions.

#### Switch «A»

- «0» Parking lights.
- «1» Low beam.
- «2» Lights off.

#### Switch «B»

With switch «A» in position «1»:

- «3» Low beam.
- «4» High beam.

### Horn, flashing light and turn signal buttons (fig. 6)

Are fitted on the L/H of handlebar.

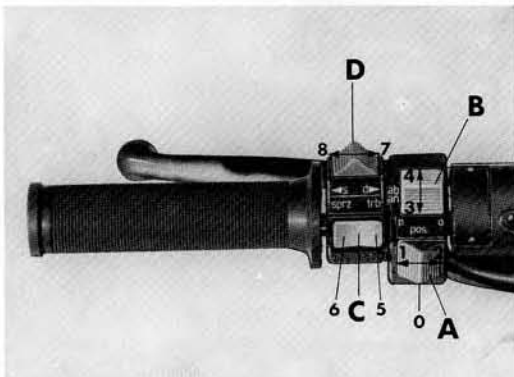

6

#### Buttons «C»

- «5» Horn.
- «6» Flashing light.

#### Switch «D»

- «7» Right turn lights.
- «8» Left turn lights.

### Engine starting and emergency stop button (fig. 7)

Right on handlebar. With ignition key in position

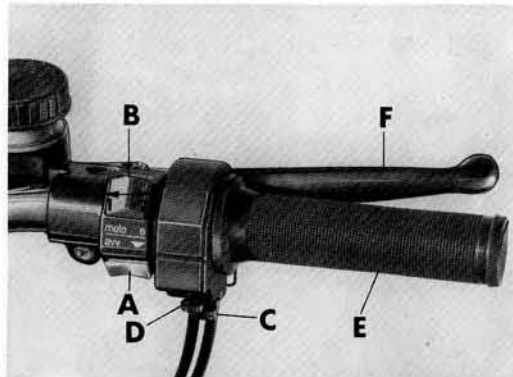

7

- 16 «A» (fig. 4) the engine is ready to be started. To start the engine proceed as follows:
- ensure switch «B» is in position «1» (run);
  - pull the clutch lever completely;
  - on a cold engine bring starter lever «B» in the start position (fig. 28);
  - press start button «A» (start).
- To stop the engine in case of an emergency:
- shift switch «B» to position «2» (OFF).
- After stopping the engine, turn ignition key (fig. 4) anticlockwise until mark «OFF» is in line with the mark on the panel and take out the key.

### Easy start lever on carburettor (fig. 28)

This lever for starting a cold engine is located near the left cylinder head cover:

- «B» Start position.
- «C» Riding position.

### Throttle grip control («E», fig. 7)

Right, on the handlebar. Throttle is opened by turning towards the rider and closed viceversa.

### Clutch control lever

Left, on the handlebar. Use it only for engine starting and gearshifting.

### Right front brake control lever («F», fig. 7)

Right, on handlebar. This lever is suitably connected to the master cylinder and operates on right front brake disc.

### Twin brake control, front left and rear brakes (fig. 16)

The control pedal is located on the right side of the motorcycle and is linkconnected to the fluid reservoir (master cylinder) group. It operates both front left and rear brakes at the same time.

### Gear control (fig. 8)

This pedal is located on the left hand side of the motorcycle.

Positions:

- low gear: front lever towards the ground;
- 2nd, 3rd, 4th, and top gears: rear lever towards the ground.

*Before actuating this rocking pedal pull the clutch lever completely.*



8

### Fuel filler cap (fig. 9)

17

To obtain access to the filler cap it is necessary to turn key «A» on the protection cover anticlockwise, when the cover and cap can be lifted.

### Fuel level («A», fig. 10)

The fuel level (reserve) is warned by a lighted indicator on the panel («11» in fig. 4) which is connected with cutout «A» fitted on the right front of the tank.

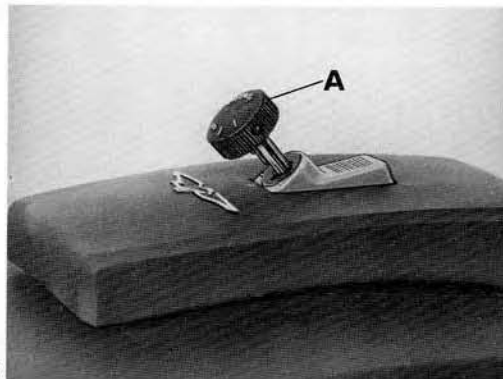

9

## 18 Fuel taps («B», fig. 10)

Are fitted at the rear of the tank and have three positions:

- «ON» Open, lever upwards.
- «RES» Reserve, arrow on lever downwards.
- «OFF» Closed, arrow on lever horizontal.

## Electrovalve (fig. 28)

Electrovalve «A» is mounted on the left side of

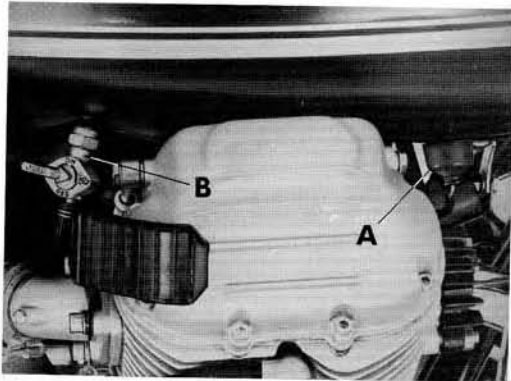

10

the motorcycle under the fuel tank and feeds the carburetors.

It comes into action when the key in fig. 5 is in position «2».

## Terminal block with fuses (fig. 11)

It is located on the right side of the motorcycle and can be accessed to by removing the R/H side cover and then the terminal block cover. N. 6 fuses of 16 A are fitted.

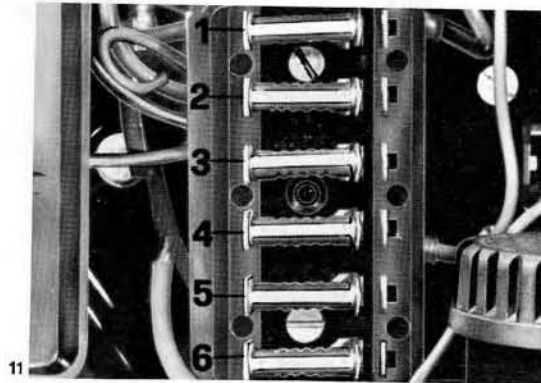

11

### Key controlled

- «1» Rear stop light, horn, flash.
- «2» Starter relay, warning light «n», electrovalve.
- «3» Warning lights: Oil, gen, brake, fuel, headlight, low and high beams and their warning lights.
- «4» Parking lights, instrument lighting, warning light «L».

### Out of key control

- «5» Additional courtesy light.
- «6» Turn signal lights and their indicators.

## Steering lock («A», fig. 12)

To lock or unlock the steering proceed as follows:

### Locking

- turn the handlebar fully to the right;
- insert the key in the lock set, turn it counter-clockwise, push it right in, release it, and slip it out.

12

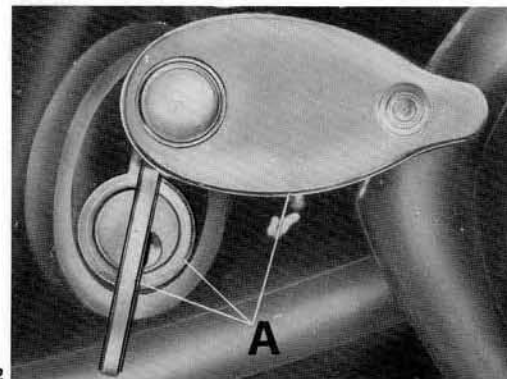

12

### Unlocking

- insert the key in the lock set, turn it counter-clockwise, then release it and slip it off.

19

## Motorcycle side stand (fig. 13)

The motorcycle is equipped with a side jack for use as side stand during brief stops.

For long stops it is advisable to always use the center stand.

20 When it is in the parking position (fully out), a special device cuts off the current.

When key of switch «B» is in line with the mark on the revcounter bracket, warning light («8», fig. 4) on the panel warns by flashing that before starting the side stand has to be raised or else the byke will not start.

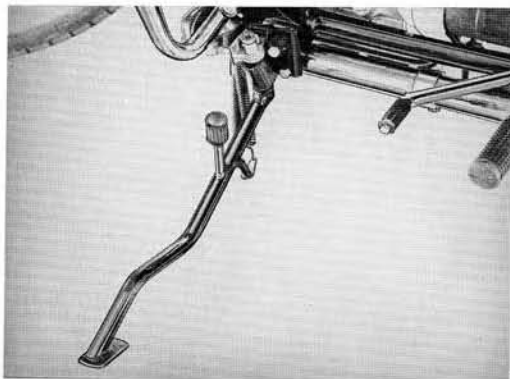

13

## RIDING INSTRUCTIONS

21

### Controls before starting

Ensure that:

- ignition key is in the start position (mark «A» on key has to be in line with mark «B» on the rev-counter panel (fig. 5);
- there is sufficient fuel in the tank (warning light «fuel» is out);
- warning light «brake» (fuel level in braking circuit (reservoirs) is not lit);
- the oil in the sump is at correct level;
- the following warning lights are lit: «oil» (red), «gen» (red), when night riding: «1» red for USA, green for Europe);
- «starter» control lever for cold engine start is in position «B» (fig. 28).

### Starting a cold engine

After checking the above, turn twist grip  $\frac{1}{4}$  turn towards the rider, pull the clutch lever fully, and press start button «A» (fig. 7).

As soon as the engine has started and before returning the starter lever in riding position «B» (fig. 28) allow the engine to idle for a few seconds in the hot season and a few minutes in the cold season.

Should the starter lever be left in starting position «B» when riding, there would be irregular carburation and increased fuel consumption: worse still, the engine might seize because of too much petrol going into the cylinders.

*Caution - If the orange light in the panel does not light up when mark «A» on the key is lined up with mark «B» on the rev-counter bracket (fig. 5), this means a gear is engaged and the pedal has to be moved to the neutral position in between low and second gear.*

### Starting a hot engine

Same as for a cold engine, except that in this case «starter» lever has not to be set to the start position «B» (fig. 28) as this would richen the carburation too much.

## 22 On the way

To change up or down pull the clutch lever completely and engage the next gear. Release the clutch lever gently, accelerating at the same time. The gearshift pedal should be actuated firmly and accompanied with the foot.

When shifting down to a lower gear, operate the brake and throttle controls gradually so as not to cause the engine to **over rev** when the clutch lever is released.

### Stopping the motorcycle

Close the gas, pull the brake lever and press down the brake pedal gently, pulling the clutch lever only when the byke is almost to a standstill.

This operation should be done with co-ordination so as to keep the vehicle under control.

To reduce the speed gradually, use the engine braking power by correctly changing gear, paying attention not to **cause the engine to over rev**. On wet or slippery roads, the brakes — especial-

ly the front one — should be used with caution. To stop the engine turn the ignition key to position «OFF» (fig. 4).

When the engine is stopped, always close the fuel taps.

### Parking

When parking at night on insufficiently lighted roads, switch on the parking lights by turning the ignition key to the position where mark «A» on the key is in line with mark «B» on the rev-counter panel (fig. 5) and the light switch in fig. 6 is in line with position «ON».

Then remove the key and lock the steering. See «Steering lock» fig. 12.

## RUNNING IN

23

During the running in period follow strictly these recommendations:

- 1 Before starting allow the engine to warm up, letting it idle for a more or less period of time, according to the external temperature.
- 2 Never exceed maximum permissible speeds in each gear. Avoid running at the same number of revolution for long periods but change gear frequently.
- 3 Before stopping, reduce the speed gradually

to prevent the various engine groups from undergoing abrupt changes of temperature.

4 Make sure all the operation specified in the service voucher have been carried out at the stated mileages.

5 Dont forget that proper bedding down of all components will only occur after several thousands of miles have been covered. This will allow you to obtain excellent performance from your motorcycle for a long period of time.

### Maximum running in speeds

Distance covered	Maximum permissible spees				
	Low gear	2nd gear	3rd gear	4th gear	High gear
Up to 800 km (500 miles)	45 km (29 mph)	65 km (40 mph)	85 km (53 mph)	100 km (63 mph)	115 km (72 mph)
From 800 km (500 miles) to 1600 km (1000 miles)	55 km (34 mph)	80 km (48 mph)	105 km (63 mph)	120 km (74 mph)	140 km (87 mph)
From 1600 km (1000 miles) to 3000 km (1900 miles)	Gradually increase the above limits up to the maximum admissible speed.				

24 After the first 500 km (300 miles)  
1000 km (600 miles)

Change the crankcase oil. **Should the oil level fall under the minimum level mark before the engine has reached 500-1000 km (300-600 miles), it will be necessary to change the oil instead of topping up.**

Recommended oil: «Agip Sint 2000 SAE 10W/50».

Check tightness of all nuts and bolts.

Adjust valve rocker clearance.

Check contact breakers gap.

Check spokes tension.

## MAINTENANCE AND ADJUSTMENTS

25

### Adjusting the clutch control lever (fig. 14)

If the free play at the handlebar is more or less than 3-4 mm (.118-.157"), act on adjuster «A» to restore the correct play

This adjustment can also be carried out by slackening counternut «C» and acting on adjuster «B» on the right side of the gear box.

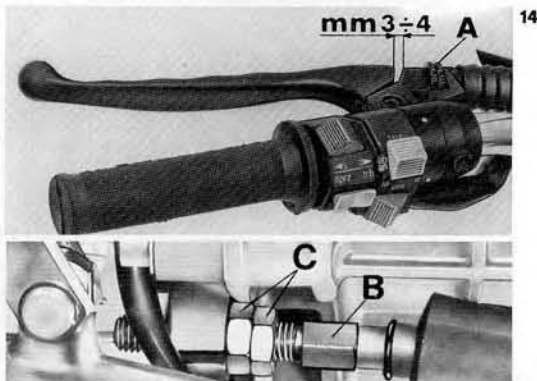

### Adjusting the right front brake control lever (fig. 15)

Proceed as follows:

- insert a feeler gauge «A» between the floater in master cylinder and the control lever end;
- turn thumb screw «B» to obtain the correct play which is 0.05 ÷ 0.15 mm (.0019-.0059").

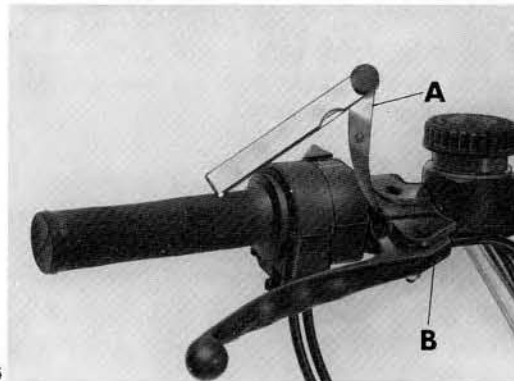



## 26 Checking wear of the brake pads

Every 5000 km (3000 miles) check thickness of the brake pads.

- New pad 9 mm (.3543").
- Wear limit 6 mm (.2362").

If thickness is below the wear limit, it is necessary to replace the pads.

After this operation has been carried out there is no need to bleed the air from the braking circuits but only to operate the control lever on the handlebar («B» in fig. 15) several times until the caliper pistons reach their normal position.

When replacing the pads, check also the condition of the fluid ducts: if in any way damaged, replace them immediately.

### Checking the braking discs

(fig. 16 and 17)

The discs should be perfectly clean, without oil, grease or other impurity, also without any deep scoring.

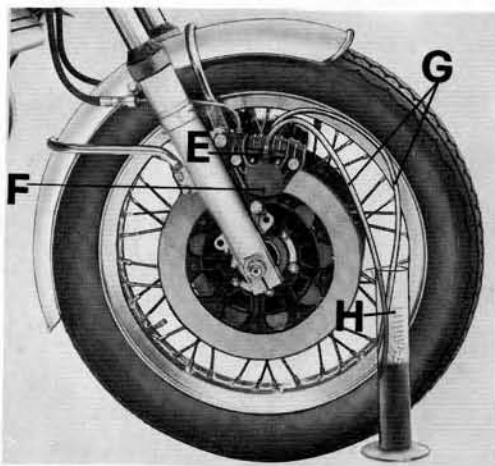
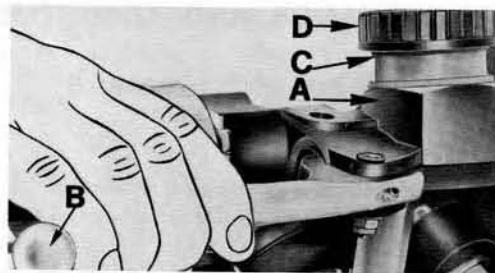

16

In case of replacement or overhauling of the brake discs, it is necessary to check their fluttering. This control is done using a suitable gauge which should never exceed a reading of 0.2 mm (.0079"). If the «fluttering» is higher, have the discs checked in a shop of one of our dealers.

### Checking the fluid level and replacing the brake fluid in the reservoirs (master cylinder)

(fig. 16 and 17)

For proper braking operation, the following instructions should be observed:

- 1 Periodically check the fluid level in the reservoir. This level should always be over the transparent section of the reservoir «C».
- 2 Periodically check and top up fluid reservoir «A», after loosening plug «D» and removing the diaphragm (see fig. 16).

The fluid level in the reservoir for the left front brake and rear brake is indicated by warning light «8» in fig. 4 on the instrument panel which is actuated by cut-out «C» (fig. 17).

To top up, undo cap «D» on master cylinder «A» (fig. 16), after disconnecting the electric wires. Use only fluid taken from an original container to be opened just before pouring in.

**3** Change all the braking fluid every 15.000 km (9000 miles) or at least once a year.

For good brake operation, it is necessary for the fluid ducts to be always full of airless fluid.

A long and elastic movement of control lever «B» indicates the presence of air bubbles in the ducts. To wash the braking circuits use only fresh fluid. Never use alcohol for washing or compressed air to dry. For metal parts use trichloroethylene. Recommended fluid: «Agip F.1 Brake Fluid SAE J 1703».

### Bleeding the air from the braking circuits (fig. 16 and 17)

This operation is required when the movement of the control lever on the handlebar or the pedal is long and elastic due to the presence of air inside the braking circuits.

Proceed as follows:

27



## 28 Right front braking circuit (fig. 16)

- turn the handlebar until the reservoir «A» is in the horizontal position;
- if necessary, fill up reservoir «A» (ensuring that during the bleeding operation, the fluid does not drop below the transparent section);
- bleed by acting on one caliper half «F» at the time as follows:

1 Remove the rubber covers and fit a transparent flexible duct «G» on drain plugs «E» with

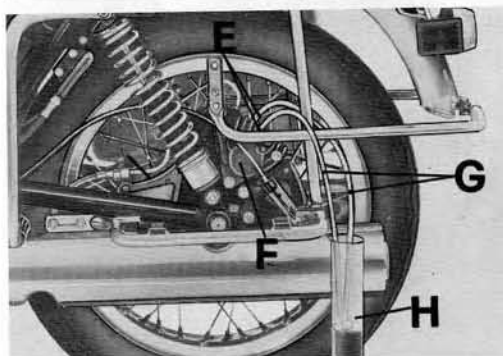
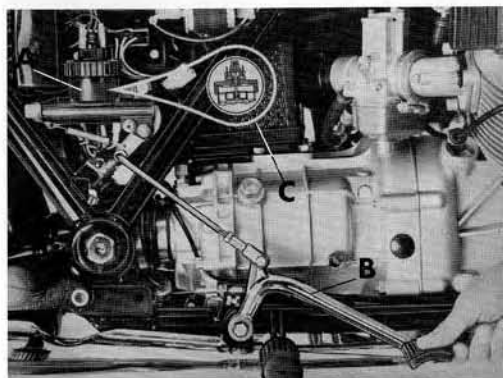
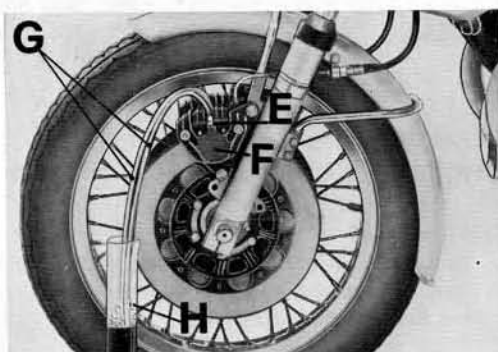

17

the other end of the duct plunged into a transparent container «H» partially filled up with liquid of the same type.

2 Loosen drain plug «E».

3 Completely actuate brake control lever «B» several times, releasing it slowly and waiting a few minutes before pulling it again.

Repeat the operation until the duct end plunged into the transparent container emits airless fluid.

4 Keep control lever «B» fully pulled and lock drain plug «E». Then take out plastic duct «G» and re-fit the rubber cover on the drain plug.

If the air bleeding has been carried out correctly, a direct and efficient working of the fluid will be perceived immediately after the initial idle movement of lever «B».

If not, repeat the operation.

## Front left and rear braking circuit (fig. 17)

Follow the same procedure as described in chapter «Checking the fluid level and replacing the

brake fluid in the braking circuits», except point «1» and in «Braking circuit for the right front brake» except points «3» and «4».

29

### Level

1 It is indicated by warning light «B», fig. 4 on the panel. When it lights up it is necessary to top up.

### Bleeding

- 3 Press down completely control pedal «B», etc.
- 4 Keep the pedal pressed down, etc.

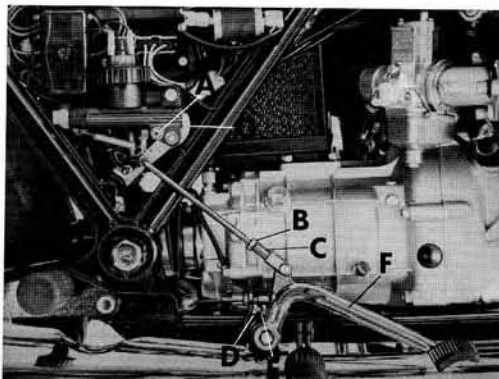

18

### 30 Adjusting the front left and rear brake pedal (fig. 18)

Check clearance between floater and control lever «G» (on master cylinder), proceeding as follows:

- fit a feeler gauge between the floater in master cylinder and the end of the control lever. Turn thumb screw «A» to obtain the correct play:  $0.05 \div 0.15$  mm (.0019-.0059");
- take off the circlip, slip off the pin and loosen

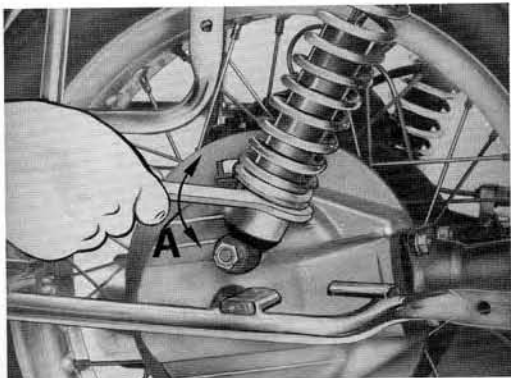

19

counternut «B», and screw in or out fork «C» until control pedal «F» comes to the desired position;

- re-fit retaining pin and circlip.
- This done, loosen counternut «E» and adjust screw «D» for lever return.

### Adjusting the rear suspensions (fig. 19)

The external springs of the rear suspensions can

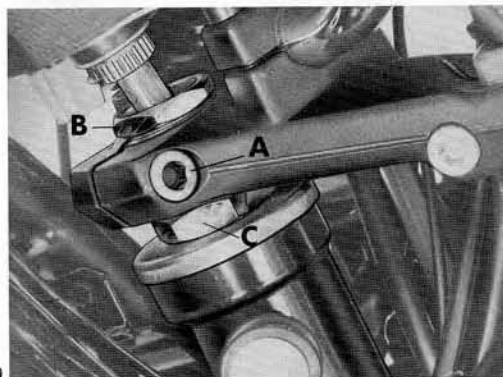

20

be adjusted to three positions using lever «A» in the kit.

If an irregular operation of the hydraulic dampers is noticed, have them checked in one of our dealers workshops.

*Caution - Do not forget that the two springs have to be adjusted to the same position to ensure good stability to the motorcycle.*

### Adjusting the steering (fig. 20)

For safe riding the steering has to be adjusted so as to allow free movement to the handlebar, but without excessive play.

To correctly adjust, proceed as follows:

- slacken steering head fixing bolt «A»;
- undo steering head nut «B»;
- screw in or out adjuster nut «C» to take up the excessive play.

This done, tighten nut «B» and steering head fixing bolt «A».

It is well for this operation to be carried out by one of our dealers.

31

## 32 REMOVAL OF WHEELS

### Front wheel (fig. 21)

To remove the front wheel, operate as follows:

- undo screws «F» and «G» securing caliper «A» to the left fork cover. Now take out caliper from the brake disc by lifting it slightly;
- undo spindle retaining nut «B» on the right side;
- undo screws «C» fixing fork covers to spindle;
- withdraw spindle «D»;
- lift up the front part of the motorcycle just sufficiently to allow the brake disc to be taken out of the caliper still mounted on the right fork cover.

Re-fitting is a reversal of the removing operation but particular attention should be paid to the position of spacer «E» on the right.

- undo the screws securing the muffler to frame (left), loosen the strap securing screw, and take out the muffler from the exhaust pipe;

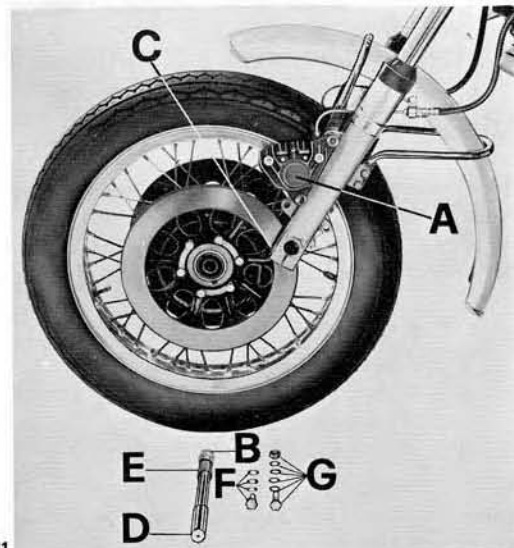

### Rear wheel (fig. 22)

To remove the rear wheel, proceed as follows:

- undo nut «B», drive box side;
- undo screw securing spindle «C» to the rear fork arm;
- withdraw spindle «D» from drive box, brake hob, swing arm;
- withdraw braking disc from caliper «E»;
- after disconnecting the parking brake control cable, slip off the plate complete with hydraulic and mechanical calipers. Do not disconnect the hydraulic duct;

- lean the vehicle to the right so as to allow wheel «F» to be slipped off from the rear fork arm and the drive box.

When re-fitting, proceed in reverse sequence, making sure to **insert the plate complete with calipers in the rear fork lug** and to hook the parking brake cable to its operating rod.

- turn the wheel and check its truing using a suitable gauge. If necessary adjust the right or left spokes until the wheel turns properly. This check has to be done after the first 500 km (300 miles) and then every 1500 km (900 miles).

33

### Adjusting the spokes

Check that all spokes are tight and trueness of the wheel as follows:

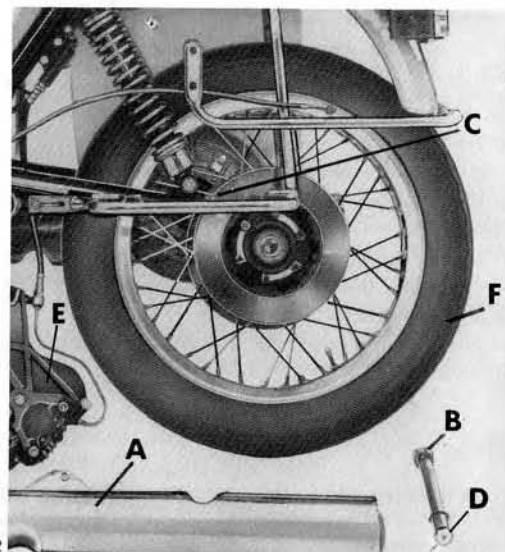

## 34 Wheel balance

To improve the vehicle stability and decrease vibrations at high speeds, the wheels have to be kept well balanced.

Proceed as follows:

- ensure that all spokes are tightened and the wheel is true;
- remove the wheel and suspend it on a fork;
- lightly spin the wheel several times and see if it always stops in various positions, thus indicating a correct balance;
- if one point of the wheel always stops at the bottom, put a balance weight on the spoke opposite this point;
- repeat the operation until the wheel is correctly balanced, then fix the balance weights to the spokes by means of pliers.

Balance weight are readily available from our dealers.

### Tires

Tires are included in the components which must be very carefully checked as the vehicle stability, riding comfort and even the rider's safety are de-

pendant on them. Therefore it is not advisable to use tires having less than 2 mm (1/16") thickness tread.

An incorrect tire pressure may also affect the vehicle stability and cause rapid deterioration of the tire.

Recommended pressures are:

#### Front wheel

— solo or with pillion: 2.1 kg/sqcm (30 p.s.i.).

#### Rear wheel

— solo: 2.4 kg/sqcm (34 p.s.i.);

— with passenger: 2.6 kg/sqcm (36 p.s.i.).

The above figures are for normal riding (cruising speed).

If using the motorcycle at constant high speed or on highways, it is recommended to increase the pressure by 0.2 kg/sqcm (3 p.s.i.).

### Mounting tires on rims

If the tires have an arrow stamped on one side, this has to turn clockwise for the rear wheel and anticlockwise for the front wheel.

## LUBRICATION AND MAINTENANCE

35

### Monthly or about every 3000 km (2000 miles)

- Check the electrolyte level in the battery (see **Electrical Equipment** «Battery»).

### Periodically

- Check tire pressure (see **Removal of wheels** «Tires»).

### Every 500 km (300 miles)

- Check the crankcase oil level (see **Engine lubrication**).

### After the first 500-1000 km (300-600 miles)

- Renew the oil in the crankcase (see **Lubrifications** «Engine lubrication»).
- Check tightness of all nuts and bolts.
- Check tightness of all wheel spokes and wheel

trueing (see **Removal of wheels** «Adjustment of spokes»).

- Check rocker clearance (see **Valve gearing**).

### Every 1500 km (900 miles)

- Check tightness of all wheel spokes. Ensure the wheel is true (see **Removal of wheels** «Adjustment of spokes»).

### Every 3000 km (2000 miles)

- Replace the crankcase oil (see **Lubrifications** «Engine lubrication»).
- Check rocker clearance (see **Valve gearing** «Adjusting rocker clearance»).
- Check oil level in gearbox (see **Lubrifications** «Lubrication of gearbox»).

### Every 5000-6000 km (3000-4000 miles)

- Check the fluid level in the reservoir (master

- 36 cylinder) for the right front brake. An incorrect fluid level for the left front brake and rear brake is warned by an optical indicator (red) on the panel (see **Maintenance and adjustments** «Checking and replacing the brake fluid»).

### Every 10.000 km (6000 miles)

- Clean the fuel tank, fuel filters, and pipes (see **Carburation** «Cleaning fuel tank, fuel taps, fuel filters, and pipes»).
- Replace the oil in the gearbox (see **Lubrifications** «Lubrication of the gearbox»).
- Replace the oil in rear drive box (see **Lubrifications** «Lubrication of rear drive box»).
- Clean and smear with jelly all battery connections (see **Electrical equipment** «Battery»).
- Replace the air filter (see **Carburation** «Air filter cartridge»).

### Every 15.000 km (9000 miles)

- Replace the fluid in the braking circuits (see **Maintenance and adjustments** «Checking and replacing the fluid in braking circuits»).

- Replace the oil filter cartridge (see **Lubrifications** «Replacing the oil filter cartridge and cleaning the wire gauze filter»).

### After the first 20.000 km (12.000 miles)

- Have your dealer make the following controls:
  - checking condition of wheel bearings;
  - checking that steering bearings are sufficiently greased (Agip F.1 Grease 30).
- Replace the oil in the fork legs (see **Fork lubrication**).
- Clean starter motor and generator commutators using a clean rag lightly moistened in petrol.

## LUBRICATIONS

37

### Engine lubrication (fig. 23)

#### Checking the oil level

Every 500 km (300 miles) check level of crankcase oil.

Correct level is in proximity of the top mark on the dipstick «A».

If lower, top up with oil of same quality and density.

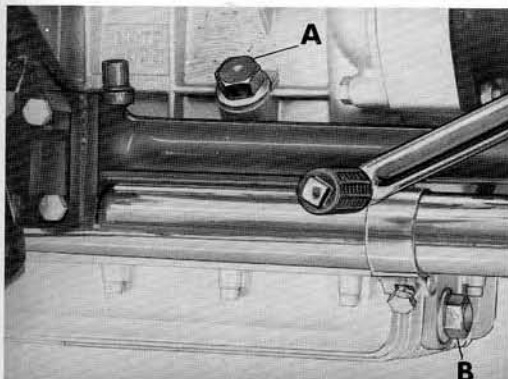

Allow the engine to idle a few minutes before checking the oil level, ensuring the filler cap-dipstick «A» is fully screwed in.

#### Replacing the crankcase oil

After the first 500-1000 km (300-600 miles) and later on every 3000 km (2000 miles) or so, replace the oil in the crankcase. Do this operation on a warm engine, allowing the old oil to drain completely before adding fresh oil.

«A» Filler cap dipstick.

«B» Oil drain plug.

Quantity required: 3 l of «Agip Sint 2000 SAE 10 W/50» (approx. 3 qts).

### Replacing the oil filter cartridge and cleaning the wire gauze filter (fig. 24)

Every 15.000 km (9000 miles) (5 oil changes), replace the filter cartridge proceeding as follows:

- undo plug «B» and let the oil drain fully;
- undo fixing screws and remove the oil sump.



38 Filter cartridge «A» and wire gauze filter «D» are mounted inside the sump;

- undo filter cartridge «A» and replace it with an original one.

When replacing filter cartridge «A», it is recommended to also remove wire gauze filter «D», washing this in a petrol bath and drying it with a compressed air jet. Before mounting it, blow through the oilways in the sump with compressed air.

Finally, do not forget to replace the sump gasket. This servicing is best done by our dealers.

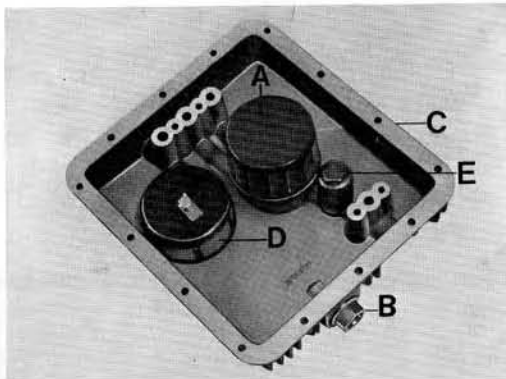

24

## Lubrication of the gearbox (fig. 25)

Every 3000 km (2000 miles) ensure the oil level is nearly at the top of inspection hole «B». If lower, top up with oil of same quality and density.

### Replacing the oil

Every 10.000 km (6000 miles) replace the oil in the gearbox.

This operation has to be done on a warm engine when the oil is more fluid and easily drained.

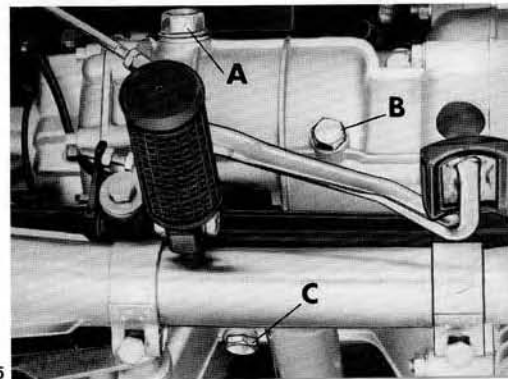

25

- «A» Filler cap.
- «B» Level checking cap.
- «C» Oil drain plug.

Quantity required: 0.750 l (abt 25 oz) of «Agip Rotra MP SAE 90».

## Lubrication of rear drive box (fig. 26)

### Checking the oil level

Every 3000 km (2000 miles) check that the oil level is nearly skimming the hole of level cap «A». If lower, top up with oil of same quality and density.

### Oil change

Every 10.000 km (6000 miles) change the oil in the rear drive box.

Do this on a warm engine as the oil is more easily drained.

Let the old oil drain fully before introducing fresh oil. 39

- «A» Filler cap.
- «B» Level cap.
- «C» Oil drain plug.

Quantity required: 0.250 l of which 0.230 l ( $\frac{3}{4}$  pint) of oil «Agip F.1 Rotra MP SAE 90» and 0.020 l (approx.  $\frac{3}{4}$  oz) of «Agip Rocol A 50/R».

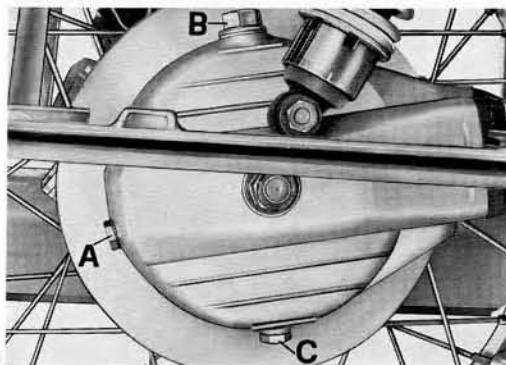

26

## 40 Fork lubrication (fig. 27)

To replace the oil in the fork legs, proceed as follows:

- undo the drain plug with gasket «A»;
- undo allen screw «B».

Before introducing fresh oil allow all the fork leg oil to drain completely.

«A» Oil drain screw.

«B» Oil filler screw.

Quantity required: 0.070 l (abt 1 and  $\frac{3}{4}$  oz) or about half a glass for each leg of «Agip F.1 ATF Dexron».

## Lubrication of the steering and rear fork bearings

This operation is best carried out by our dealers.

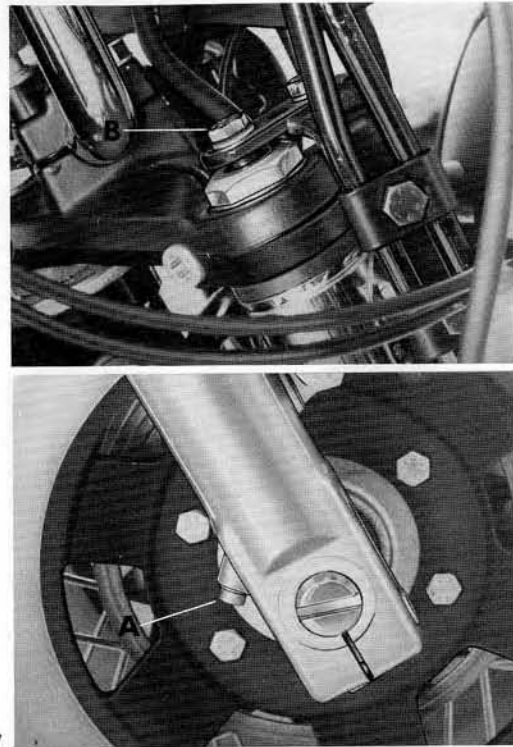

27

## CARBURATION

41

### Carburetors (fig. 28)

This model fits 2 Dell'Orto make carburetors type WHB 30 CD (right) and WHB 30 CS (left).

#### Controls

Throttle control grip («B» in fig. 7) on the right handlebar.

Starter lever, for starting a cold engine, in the left cylinder head cover.

«B» Starting position.

«C» Riding position.

*Note - With the starter lever in position «C» (riding), check that there is a clearance of 3 mm (.11") between cable ends and adjuster screw «H» of both carburetors.*

#### Standard carburettor setting

Choke	∅ 30 mm
Throttle valve	40
Atomiser	265
Main jet	130

Idling jet	50
Starter jet	80
Needle	V 9 (2nd notch)
Floater	10 gr

Idling screw adjustment: open 1 and a half turns.

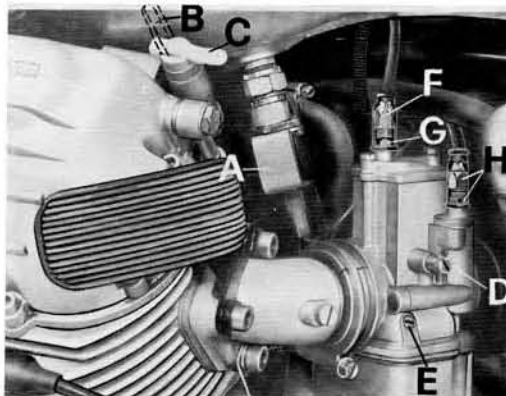

28



## 42 Adjusting the carburation and idling speed (hand adjustment) (fig. 28)

Proceed as follows:

- 1 Warm the engine up to its normal running temperature.
- 2 Screw in fully idling adjusters «E».
- 3 Check with your hands if the exhaust pipe pressures are equal. If necessary, act on screw «D» of one carburettor until the exhaust pressures of both carburettors are the same (idling speed should be kept at no more than 900-1000 rpm and consequently it may be necessary to screw in the screw of the carburettor for the cylinder giving a lower exhaust pressure, or screw out the screw of the carburettor for the cylinder giving a higher exhaust pressure).
- 4 Acting on screws «E» get the best carburation for each cylinder (this is perceived by an increase of rpm) and then adjust idling speed according to point 3.
- 5 Disconnect one spark plug lead at the time

and check that in both cases the engine stops after firing 5-6 strokes. If it does not, screw out screw «D» of the carburettor making the engine fire more than 5-6 stroke or screw it in for the carburettor making the engine fire less than 5-6 strokes.

- 6 Adjust idling speed at 900-1000 rpm by screwing or unscrewing both screws «D» **by the same amount.**

- 7 With the throttle grip closed, ensure there is a clearance of 1-1.5 mm (.039-.059") between cable ends and cable adjuster screws «F» of both carburettors.

- 8 Ensure that the throttle valves open simultaneously by proceeding as follows: gradually turn the throttle control grip and check that the exhaust pipe pressure increases in synchronization with your hands (an assistant is necessary for this operation).

If pressure increase of one cylinder is advanced, act on its carburettor by gradually screwing in cable adjuster «F», after loosening conernut «G», until the synchronization of both exhaust pipes pressure is reached.

## Adjusting the carburation by means of a vacuumeter

In order to obtain a correct adjustment of the carburation it is necessary to apply to our dealers who can carry out this operation by means of a vacuumeter.

### Air filter cartridge (fig. 29)

Every 10.000 km (6000 miles) air filter cartridge «A» should be changed.

This filter is located in a suitable container together with the oil breather assembly, under the fuel tank.

For this replacement it is recommended to apply to our dealers.

### Cleaning the fuel tank, fuel taps, fuel filter, and pipes

Every 10.000 km (6000 miles) or in case of irre-

gular fuel flow to the carburettors, it is necessary to clean the fuel tank, the fuel taps, the filters on the carburettors, and the fuel pipes. All these parts are best cleaned using petrol and dried off with compressed air.

43

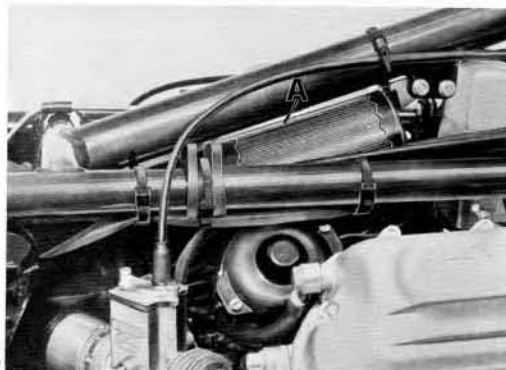

29

## 44 VALVE GEARING

### Tappet clearance (fig. 30)

After the first 500-1000 km (300-600 miles) and later on every 3000 km (2000 miles) or any time valve operation is too noisy, check tappet clearance.

This adjustment is made on a cold engine with the piston at TDC at the end of the compression stroke (valves fully closed).

After removing the rocker covers, operate as follows:

- 1 Slacken nut «A».
- 2 Screw in or out adjuster «B» till the following clearance are obtained:
  - 0.22 mm (.0086") for both the inlet and exhaust valves.

This check is made using a feeler gauge «C». In case of higher clearance, there will be noisy valve operation while if the valves do not close fully there will be inconveniences such as:

- compression loss;
- overheating of engine;
- burning of valves.

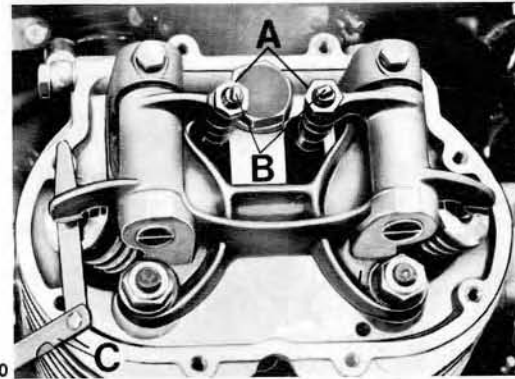

## IGNITION

### Checking and adjusting the double contact breaker (fig. 31)

#### Maintenance

Every 3000 km (2000 miles) lightly moisten cam felt pad «R» with a few drops of engine oil.

#### Inspection

- remove the contact breaker cover prior to undoing its securing screws;
- if contacts «A» and «B» are greasy or dirty, clean them with a petrol soaked rag. If damaged or worn, replace them;
- check points gap of breaker «A» (right cylinder - red cable) and breaker «B» (left cylinder - green cable) which should be in between 0.37-0.43 mm (.014-.016").

#### Adjusting the contact points

*Contact points «A» - right cylinder*

Bring cam to the maximum lift, loosen screws

«C» and «D» and move plate «E» by acting on notch «F».

After setting to the correct distance, lock screws «C» and «D».

*Contact points «B» - left cylinder*

Bring cam to the maximum lift, loosen screws «G» and «H» and move plate «L» by acting on notch «M».

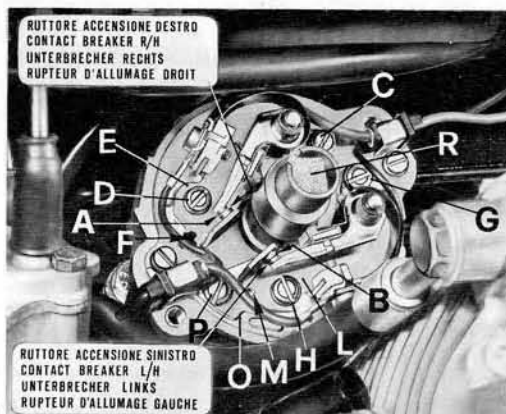

45

- 46 After setting to the correct distance, lock screws «G» and «H».
- When adjusting the contact points, the ignition timing should be checked as well (see following chapter).

### Control and adjustment of ignition timing «fixed advance» (fig. 32)

#### Inspection

- remove the rubber cap which seals the inspection hole located on the R/H side of the reducer box opposite the flywheel;
- to find the exact moment when points «A» and «B» (fig. 32) start separating, it is advisable to use an appropriate timing light to be set up between the breaker feeding clamp being checked and the ground.

#### Timing the right cylinder

- turn the flywheel anticlockwise (engine rotation) until the piston is at the end of its com-

pression stroke (both valves closed). At this stage, mark «D» stamped on the flywheel (TDC of right cylinder) should coincide with mark «1» on the inspection hole rim;

- rotate the flywheel clockwise until mark «2» on the flywheel (fixed advance) coincides exac-

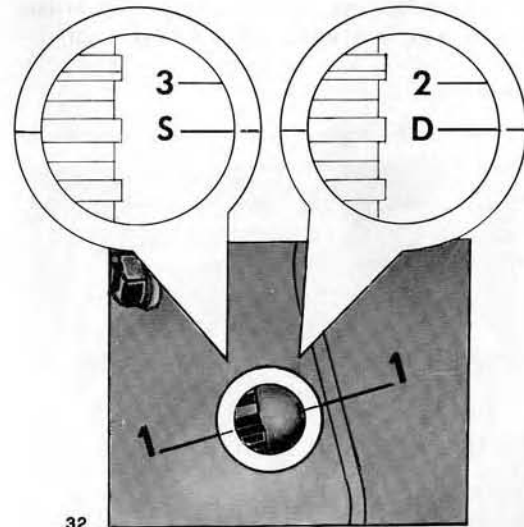

tly with mark «1» on the inspection hole rim. At this point, breaker contacts «A» should start to open.

#### Timing the left cylinder

- rotate the flywheel counterclockwise (engine rotation) until the piston is at the end of the compression stroke (both valves closed). At this point mark «S» on the flywheel (TDC of left cylinder) should coincide with mark «1» on the inspection hole rim;

- rotate the flywheel clockwise until mark «3» on the flywheel (fixed advance) coincides exactly with mark «1» on the inspection hole rim. At this point, breaker «B» contacts (fig. 32) should start to open.

If the contact points of breakers «A» and «B» (fig. 32) do not start opening in the above positions, then ignition timing needs adjustment.

#### Ignition advance data

- Initial advance (fixed)  $0^\circ \div 2^\circ$
- Automatic advance  $31^\circ$
- Full advance (f. + a.)  $31^\circ \div 33^\circ$
- Breaker contact points gap: 0.37-0.43 mm (.014-.016").

For this service it is recommended to apply to our dealers. 47

#### Spark plugs

The type of spark plugs to be used is indicated at page 5.

Spark plug points gap 0.6 mm (.023").

The spark plugs are best cleaned with petrol and a wire brush, using a needle for the inner part.

In re-fitting the spark plugs, ensure they are started by hand for a few turns, completing then the operation with the wrench in the tool kit. If not properly started, the cylinder head thread may get stripped.

For all events, the plugs have to be replaced every 10.000 km (6000 miles) even if they appear to be still in good condition.

## 48 ELECTRICAL EQUIPMENT

The electrical equipment consists of:

- Battery.
- Starter motor with electromagnetic ratchet control.
- Generator/alternator, located on the front side of the crankshaft.
- Double contact breaker with autom. advance.
- Ignition coils.
- Rectifier.
- Regulator.
- Terminal block with fuses (6 fuses of «16 A»).
- Flasher relay.
- Starter relay.
- Headlight.
- Tail light, parking, stop, number plate.
- Turns light indicator.
- Ignition switch.
- Light switch.
- Turn indicators, horn and flashing light switch.
- Engine starting and stopping button.
- Electric horns.

### Battery (fig. 33)

Battery is a 12 V type with 32 A capacity. It is charged directly by the generator.

Access to the battery is obtained by:

- unhooking lifting lever «A»;
- raising the seat and keeping it up with rod «B»;
- unhooking the rubber bands «C» and disconnecting the electric wires;
- removing tool box.

### Putting a new battery into service

1 Remove seals and plugs and introduce pure sulphuric acid with specific gravity of 1,25 kg/l and at temperature not lower than 15° C (59° F) till the level is 5-6 mm (.10-.23") over the top of the plate separators or the splashguard.

2 Let the battery rest for two hours.

3 Charge the battery at an intensity equal to about 1/10th of its capacity until the current intensity rate of the acid is about 1,27 kg/l and

such rate has remained constant for at least 3 consecutive hours of charging.

Normally, 6-8 hours charge are sufficient.

4 At the end of the charge, top up the acid, plug up, and clean accurately.

### Servicing the battery under service conditions

1 The electrolyte level should always cover the separators. To top up, use distilled water. Never add sulphuric acid.

2 If too frequent water additions are required, have the electrical system checked over as the battery works in an overcharged condition and will deteriorate quickly.

3 If the battery discharges quickly, the electrical system should also be checked over.

4 In case new or second hand batteries are left unused for fairly long periods of time, it is a good rule to charge them every month.

5 Always keep the battery terminals spotlessly clean and smeared with neutral vaseline.

6 Always keep the top battery cover dry, avoiding overflows of electrolyte which will reduce insulation and corrode the battery bracket.

*Note - If the batteries are used in tropical climates (average temperature over 33° C = 92° F), it is recommended to reduce the acid gravity to 1.230 kg/l.*

49

## Replacement of light bulbs

### Headlight (fig. 34)

Undo bottom screw «B», withdraw the beam unit, take out the bulbholders and replace the bulbs.

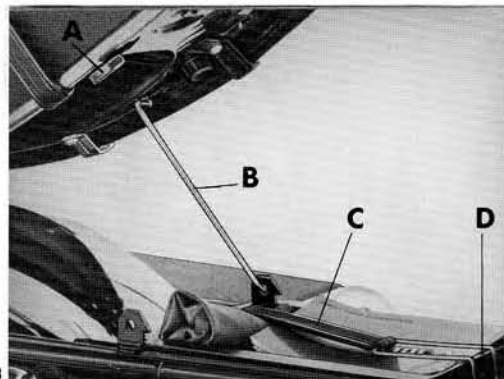

33

## 50 Tail lamp (fig. 35)

Undo screws «D» securing reflector to tail light, push bulbs inwards turning them to the left, and slip them out.

### Turn signal bulbs (fig. 35)

Undo screws «E» securing the reflectors to the lamps, push bulb inwards and turn it to the left, slipping it off.

In re-fitting the reflectors, screw in uniformly and moderately to prevent breakages.

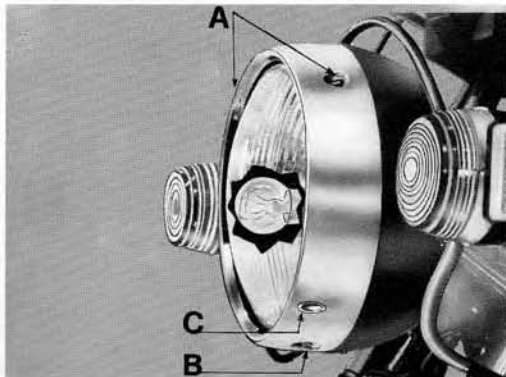

34

## Number plate light (fig. 35)

Undo screws «F» securing the transparent reflector, push the bulb inward turning it to the left, and slip it out the holder.

### Instrument panel, tachometer, and rev-counter

Slip the bulbs off their sockets and replace them.

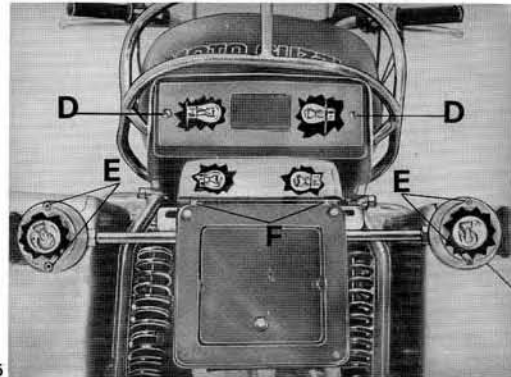

35

## Bulbs (12 V)

### Headlight

- high and low beam 45/40 W
- parking light 3 W

### Tail light

- parking and stop light 5/21 W
- number plate light 5 W

### Turn signals

- panel indicators 1,2 W
- tachometer rev-counter light 3 W

## Headlight beam adjustment (fig. 34)

For safe riding and not to trouble crossing riders, the headlight has always to be kept at correct height.

Horizontal setting is adjusted by screws «A» while vertical setting is adjusted by undoing screws «C» and shifting the headlight by hand up or down until the correct height is reached.

The center of the high beam must not be higher than 0.87 m (33") measured at 3 m (about 3.3 yards) distance with the motorcycle off the stand and rider in the saddle. 51

## 52 WIRING DIAGRAM

- 1 Tachometer (3 W bulb)
- 2 Additional courtesy light (5 W bulb) only on request
- 3 High beam warning light (1.2 W bulb) «H»
- 4 Oil pressure warning light (1.2 W bulb) «OIL»
- 5 Neutral position warning light (1.2 W bulb) «N»
- 6 Parking light (1.2 W bulb) «L»
- 7 Generator charge warning light (1.2 W) «GEN»
- 8 Low beam {
- 9 High beam { 40/45 W bulb
- 10 Turn indicator, right (21 W bulb)
- 11 Turn indicator, left (21 W bulb)
- 12 Engine starting and stopping button
- 13 Additional light switch
- 14 Turn indicator, horns, and flashing light button
- 15 Horns (Consumption 7 A)
- 16 Front brake cutout switch
- 17 Flashing light (flash) relay
- 18 Rear brake cutout switch
- 19 Battery
- 20 Regulator
- 21 Rectifier
- 22 Alternator
- 23 Starter motor relay
- 24 Starter motor
- 25 Switch on clutch control wire
- 26 Turn indicator light, left (21 W bulb), rear
- 27 Rear parking and stop light (bulb 5/21 W)
- 28 Number plate light (5 W bulb)
- 29 Turn indicator light, right, rear (21 W bulb)
- 30 Flasher unit, turn indicator lights
- 31 Oil pressure switch (on engine crankcase)
- 32 Front parking light (3 W bulb)
- 33 Terminal block with fuses (fuses 16 A)
- 34 3-way connector
- 35 4-way connector - Male AMP
- 36 Contact breaker
- 37 Coils
- 38 Ignition switch (3 positions)
- 39 Switch actuating simultaneously rear flashers
- 40 2-way connector
- 41 Spark plugs
- 42 Light switch
- 43 Right turn indicator warning light (1.2 W bulb)
- 44 Left turn indicator warning light (1.2 W bulb)
- 45 Warning light, side stand in park position (1.2 W bulb)
- 46 Brake fluid level warning light (1.2 W bulb) «Brake»
- 47 Fuel level warning light (1.2 W bulb) «Fuel»
- 48 4-way connector - Female (AMP)
- 49 Banana connector
- 50 Brake fluid level indicator
- 51 Fuel level indicator
- 52 Electrovalve (2.5 W)
- 53 Coil control device
- 54 Flasher unit for side stand warning light (parking position)
- 55 Rear parking lights (5/21 W bulb)
- 56 Rev-counter (3 W bulb)

Fold-out page for Wiring Diagram



# Wiring Diagram V1000 G5

See Page 52 for Legend

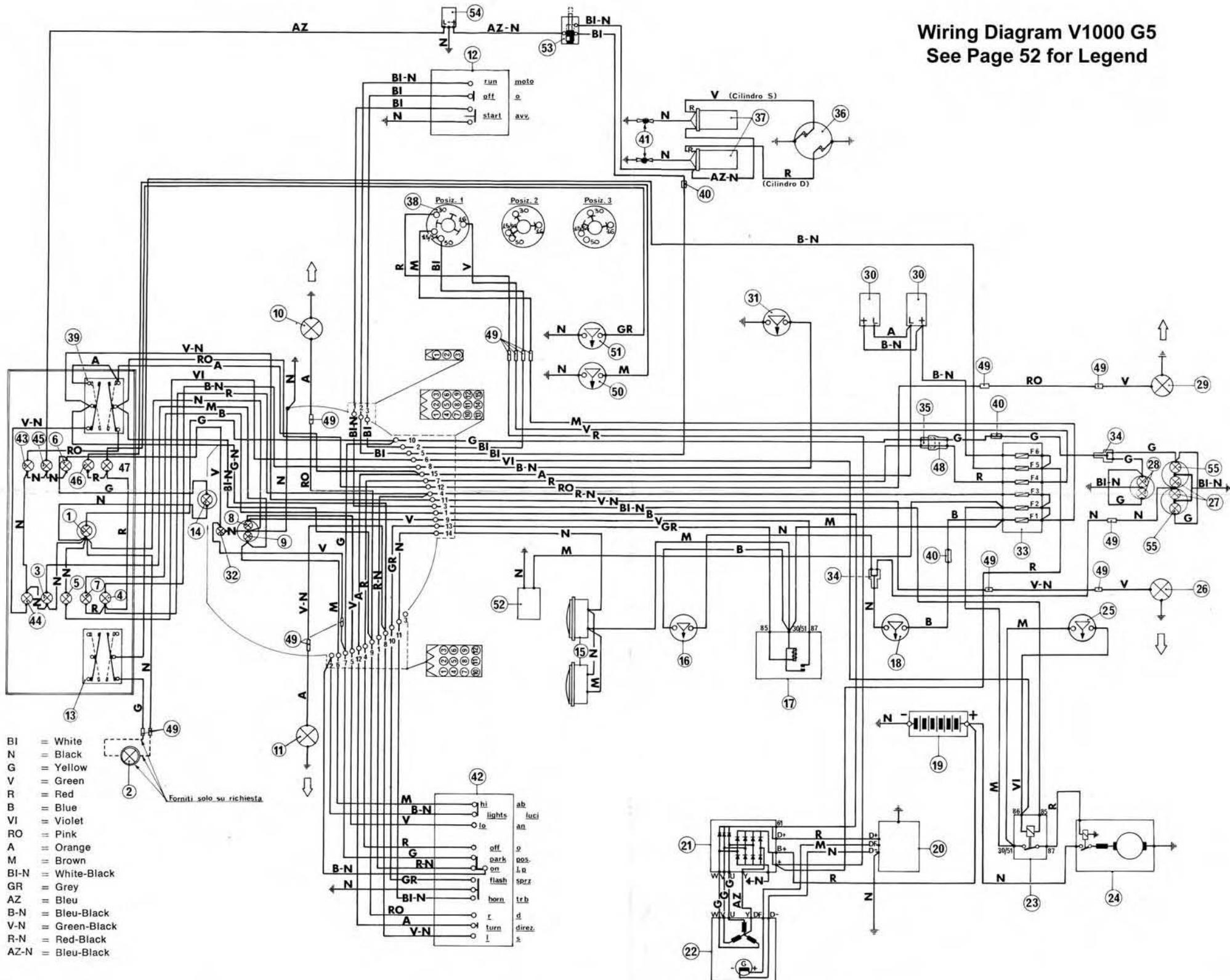

- BI = White
- N = Black
- G = Yellow
- V = Green
- R = Red
- B = Blue
- VI = Violet
- RO = Pink
- A = Orange
- M = Brown
- BI-N = White-Black
- GR = Grey
- AZ = Bleu
- B-N = Bleu-Black
- V-N = Green-Black
- R-N = Red-Black
- AZ-N = Bleu-Black

Forniti solo su richiesta

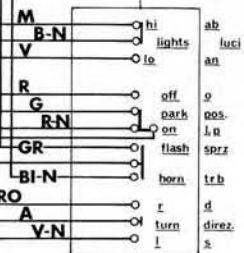





**V 1000**  
I-CONVERT

1000 **SP**

**V 1000**  
**G5**

**ADDITION TO THE OWNER'S MANUAL  
FOR USA - MODEL 1980**

LITOPRESS BERGAMO

These motorcycles conform with U.S. Environment Protection Agency Emissions Regulations applicable to motorcycles for 1980 model year. However, to maintain the vehicle within this compliance it is necessary to follow all the servicing and lubrication instructions indicated.

It is also very important for all the specified running in instructions to be strictly observed. All maintenance and lubrication jobs should al-

ways be carried out by our dealers who have qualified personnel and the necessary facilities, also original MOTO GUZZI spares.

**LABEL AFFIXED INSIDE THE L/H BATTERY COVER**

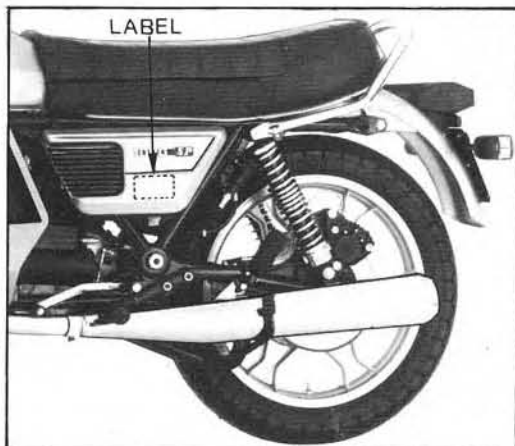

**VEHICLE EMISSION CONTROL INFORMATION**

SEIMM - Co. ITALY

Trade Mark: MOTO GUZZI

Engine Size: 948,8 c.c.

Engine Family: « VG »

Engine Tune-up specification: Adjustments performed in neutral

Breaker point gap: 0.37 - 0.43 mm.

Ignition timing: 2 degree B. T. D. C.

Idle speed: 900 ± 50 rpm (Warm engine, CO 4 ÷ 4,5 %)

- Adjustment by stop screw

- Adjustment CO% by pilot screw

Recommended Fuel: Leaded (98/100 NO-RM)

Engine oil: SE in API classification and viscosity 10 W 50 SAE

**THIS VEHICLE CONFORMS TO U. S. EPA REGULATIONS  
APPLICABLE TO 1980 MODEL YEAR NEW MOTORCYCLES**

## SERVICE SCHEDULE

ITEMS	MILEAGE COVERED ▶	900 mi. (1500 km)	1800 mi. (3000 km)	3700 mi. (6000 km)	5600 mi. (9000 km)
• Engine oil		R	R	R	R
• Oil filter cartridge		R			
• Wire gauze oil filter		C			
• Air filter				C	R
• Contact breaker points		A	A	A	A
• Ignition timing		A	A	A	A
• Spark plugs		A	A	A	R
• Rocker clearance		A	A	A	A
• Carburetion		A	A	A	A
• Nuts and bolts		A			
• Fuel tank, filters and pipes					C
Gear box oil		A	A	A	R
Rear drive box oil		A	A	A	R
Wheel and steering bearings					
Fork legs oil					
Starter motor and generator					
Brake systems fluid		A	A	A	A
Brake pads		A	A	A	A

- A = Inspections - Adjustments - Possible replacements - Servicing • C = Cleanings • R = Replacements.  
 • Operations required for maintaining the vehicle according to emission regulations.  
 Occasionally, check the electrolyte level in battery; every 500 km (300 miles) check the engine oil level. In any case, renew this oil at least once a year.

	7500 mi. (12000 km)	9400 mi. (15000 km)	11300 mi. (18000 km)	13200 mi. (21000 km)	15100 mi. (24000 km)	17000 mi. (27000 km)	18900 mi. (30000 km)
	R		R		R		R
		R					R
		C					C
		C	R		C	R	
A	A	A	A	A	A	A	A
A	A	A	A	A	A	A	A
A	A	A	R	A	A	R	A
A	A	A	A	A	A	A	A
A	A	A	A	A	A	A	A
		A					A
A	A		C			C	
A	A	A	R	A	A	R	A
A	A	A	R	A	A	R	A
				A			
				R			
				A			
A	R	A	A	A	A	A	R
A	A	A	A	A	A	A	A

## MAINTENANCE RECORD

MODEL		FRAME SERIAL NUMBER	
Recommended mileage	Workshop name	Carried out (clock reading)	Date
900 mi.			
1800 mi.			
3700 mi.			
5600 mi.			
7500 mi.			

Recommended mileage	Workshop name	Carried out (clock reading)	Date
9400 mi.			
11300 mi.			
13200 mi.			
15100 mi.			
17000 mi.			
18900 mi.			

Detailed receipts verifying the performance of required maintenance should be retained. These receipts should be transferred with the motorcycle to the new owner if the motorcycle is sold.

All servicing and maintenance procedures specified in the owner's manual still apply. However, the instructions on carburation and idling speed adjustment are changed as follows:

## CARBURATION ADJUSTMENT

Warm the engine up to its normal riding temperature by running the machine on the road for a few minutes at moderate cruising speed.

Temperatures to be reached: engine oil about 90 °C (195 °F) - cylinder head (under spark plug gasket): about 140 °C (285 °F).

With the machine in the neutral position, act on screws «D» to adjust throttle slide opening of each carburettor using a two-mercury column vacuummeter connected to the hole on the intake pipes, after removing plug «P».

Idling speed should be adjusted to 850-950 rpm, checking it with an accurate rev-counter.

Operate on screws «E» until both exhaust pipes emit the same amount of CO: 4 ÷ 4.5 %.

**Note** - If by screwing in or out adjusters «E», the idling speed adjustment should change, it will be necessary to restore it to 850-950 rpm acting again on screws «D», checking always throttle

slides opening with a vacuummeter. If necessary, adjust again the CO emission.

After this, slowly and gradually turn the twist grip control to synchronize valves opening, checking on the vacuummeter dial if in each grip position



the slides have the same opening. If not, undo locknuts «G» and act on adjusters «F».

**Note** - Before proceeding with the carburation adjustment, it is necessary to make sure that the starting and riding position («B» and «C» respectively) of the easy start device are accurately set, adjusting any slight offset through the cable adjusters.

With the easy start lever in position «C», there should be about 3 mm (.11") play between the cable terminal and adjusters «H».

If not, adjust through these, after loosening the locknuts.

**Caution** - Do not carry out any carburation adjustments before all others have been made (ignition, rocker clearance, etc.).

### Standard carburettor setting

N. 2 carburettors «Dell'Orto» type PHF 30.

Choke	∅ 30 mm
Throttle valve	50/3
Atomiser	262 AB 1
Main jet	112
Idling jet	50
Starter jet	75
Needle	K 27 (2nd notch)
Floater	10 gr

### Ignition data

Initial advance (fixed)	2°
automatic advance	31°
full advance (f. + a.)	33°
contact breaker gap	mm 0,37 ÷ 0,43 (.014" ÷ .016")
spark plugs:	Marelli CW 7 LP AC 44 XL Bosch W 225 T2 Champion N 9 Y Lodge H LNY
plug points gap	mm 0,6 (.023")

