

# **V7**

**700cc MOTO GUZZI**

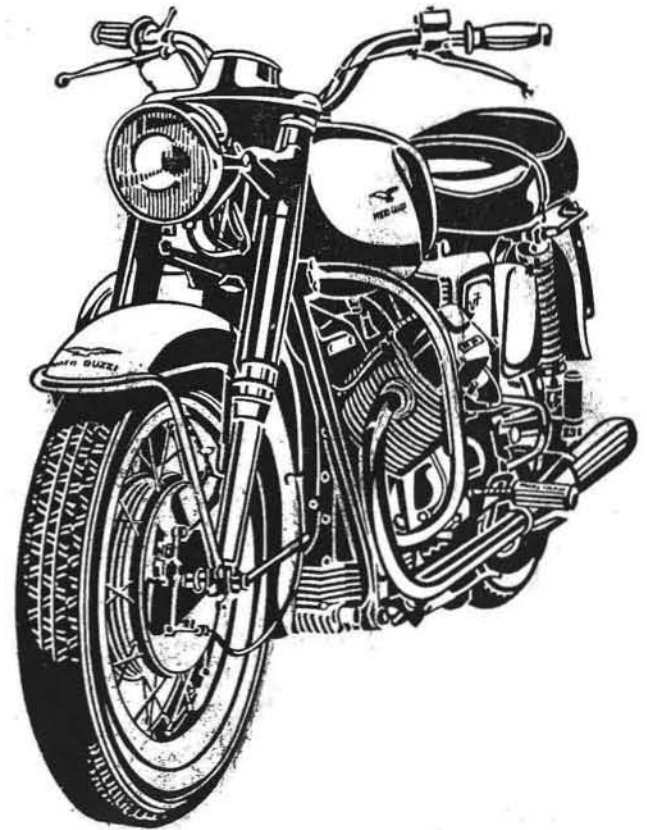

rider's handbook





## **MOTO GUZZI**

### **FACTORY AND OFFICES:**

Mandello del Lario (Como)

Via Emanuele V. Parodi, 57

Telephones:

Mandello del Lario 71.112 (4 lines)

Telegrams:

MOTOGUZZI - Mandello Lario

**HEAD OFFICE:** Via Andegari, 4

Telephone: 890632

**BRANCH OFFICE:**

**Milan**

Via Domodossola, 17

Telephone: 311.105

**Naples**

Piazza Municipio, 84

Telephone: 310.581

Telegrams: MOTOGUZZI - Naples

**700 cc**

**TWIN**

**V - 7**

**MODEL**

**RIDER'S  
HANDBOOK**

**INTRODUCTION** The purpose of this booklet is to provide owners with the necessary information on operating and maintaining their machines for maximum efficiency.

This manual should be read very carefully as most troubles and failures arising from neglect or poor maintenance will be avoided if all the instructions herein contained are strictly followed.

Dont forget that all major overhauls and repairs are best carried out by officially appointed Moto Guzzi dealers who have the necessary facilities required to competently repair your Moto Guzzi.

## INDEX

<b>Running in</b> . . . . .	pag. 5
Controls and accessories . . . . .	» 6
Identification data . . . . .	» 11
Ignition key . . . . .	» 11
Tool kit . . . . .	» 11
Spare parts . . . . .	» 11
<b>Main features</b> . . . . .	» 13
<b>Instruments and controls</b> . . . . .	» 18
<b>Riding instructions</b> . . . . .	» 21
<b>Lubrication and general maintenance</b> . . . . .	» 26
<b>Servicing instructions</b> . . . . .	» 28
Lubrication of engine . . . . .	» 28
Oil pressure relief valve . . . . .	» 28
Oil pressure gauge . . . . .	» 28
Lubrication of transmission . . . . .	» 28
Lubrication of rear wheel drive . . . . .	» 30
Lubrication of front fork and hydraulic dampers . . . . .	» 32
Lubrication of bevel gears in steering . . . . .	» 32
Lubrication of wheel bearings . . . . .	» 32
Lubrication of control cables . . . . .	» 32
Lubrication of rear fork bearings . . . . .	» 32
<b>Carburation</b> . . . . .	» 33
Filters and fuel lines . . . . .	» 33
Carburetor . . . . .	» 34
Standard carburetor settings . . . . .	» 34
Adjustment for idling speed . . . . .	» 34
Determining correct size of main jet . . . . .	» 36
Stripping of carburetor . . . . .	» 37
Air filter . . . . .	» 38
Fuel tank . . . . .	» 38

Mufflers . . . . .	pag. 39
<b>Valve gearing</b> . . . . .	» 39
Tappet clearance . . . . .	» 39
Valve timing . . . . .	» 40
<b>Ignition</b> . . . . .	» 42
Distributor . . . . .	» 42
Spark plugs . . . . .	» 42
Ignition timing . . . . .	» 42
<b>Adjustments</b> . . . . .	» 45
Generator belt . . . . .	» 45
Clutch lever . . . . .	» 45
Steering . . . . .	» 45
Front brake lever . . . . .	» 46
Rear brake pedal . . . . .	» 47
Rear suspension units . . . . .	» 49
Removal of front wheel . . . . .	» 50
Removal of rear wheel . . . . .	» 51
<b>Electrical equipment</b> . . . . .	» 54
Battery . . . . .	» 54
Generator . . . . .	» 55
Regulator unit . . . . .	» 55
Starter motor . . . . .	» 55
Horn . . . . .	» 56
Light switch, dipper switch and horn button . . . . .	» 56
Headlight . . . . .	» 56
Bulbs . . . . .	» 56
Tail light . . . . .	» 56
Fuses . . . . .	» 56
Cables . . . . .	» 56

## Running in

During the first 1600 kms. (1000 miles) a new or overhauled machine should be used intelligently since the efficiency, performance, and life of the engine are largely dependant on how it is used.

The engine should never be allowed to reach a high number of revolutions before it has had a chance to sufficiently warm up.

Never ride the machine at the highest speeds permitted for each gear before the machine has been well broken in.

Should the engine speed drop off considerably on an uphill grade, a lower gear should be immediately engaged. In case of overheating, it is best to stop the engine and allow it to cool down.

Under no circumstances whatever should the following speeds be exceeded while a machine is being run in.

Maximum permissible speed:

Distance covered:

Up to 800 kms. (500 miles):

— in low gear . . . . .	45 (28 miles)
— in second gear . . . . .	65 (40.5 miles)
— in third gear . . . . .	85 (53 miles)
— in high gear . . . . .	110 (68 miles)

From 800 to 1600 kms. (500 to 1000 miles):

— in low gear . . . . .	55 (34.5 miles)
— in second gear . . . . .	80 (50 miles)
— in third gear . . . . .	105 (65 miles)
— in high gear . . . . .	135 (84 miles)

From 1600 to 3000 kms. (1000 to 1800 miles):

Gradually increase the speed up to the maximum permissible limit.

**After the first  
500 kms.  
(300 miles)**

Change the engine oil.  
Tighten all nuts and bolts.  
Check valve clearance.  
Check distributor contacts gap.

**Every  
500 kms.  
(300 miles)**

Check oil level. Correct level is in between  
the minimum and maximum mark on the  
Filler cap dipstick.

## CONTROLS AND ACCESSORIES

(See fig. 1)

- 1 - Front brake lever
- 2 - Air control lever
- 3 - Throttle control grip
- 4 - Fuel filler cap
- 5 - Gearshift lever
- 6 - Pillion footrests
- 7 - Pillion handgrip
- 8 - Headlight
- 9 - Speedometer and lighted indicators
- 10 - Key type ignition switch
- 11 - Clutch lever
- 12 - Dipper switch and horn button
- 13 - Side stand
- 14 - Rear brake pedal
- 15 - Footrests
- 16 - Center stand
- 17 - Tail lamp

**N.B. - The terms « right » and « left » in the text  
are used in the sense they would appear to one  
sitting in the saddle.**

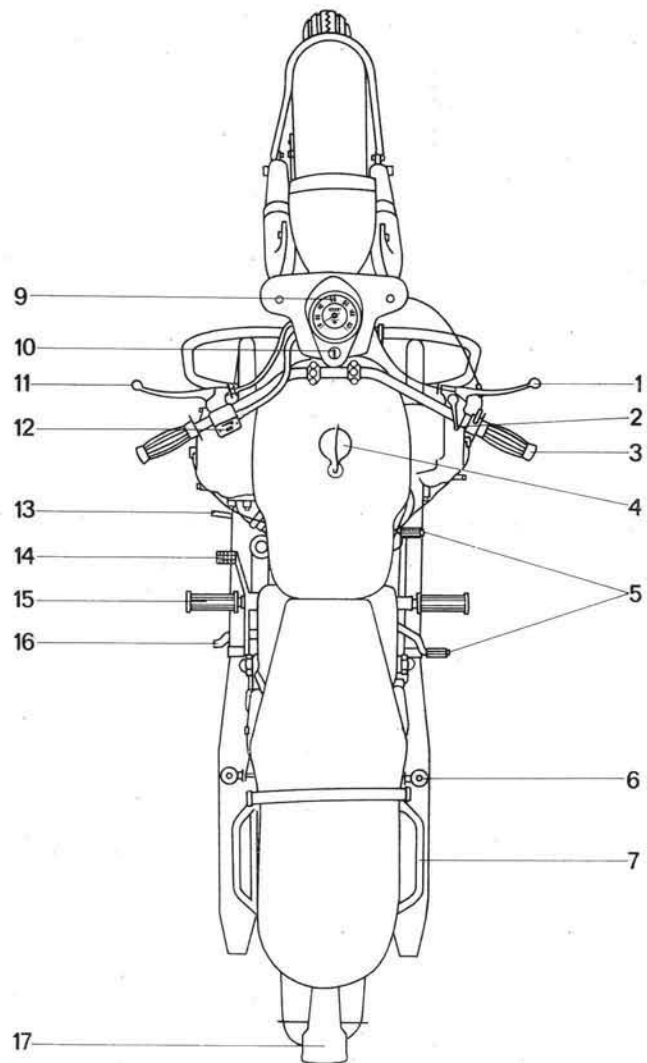

**Fig. 1**

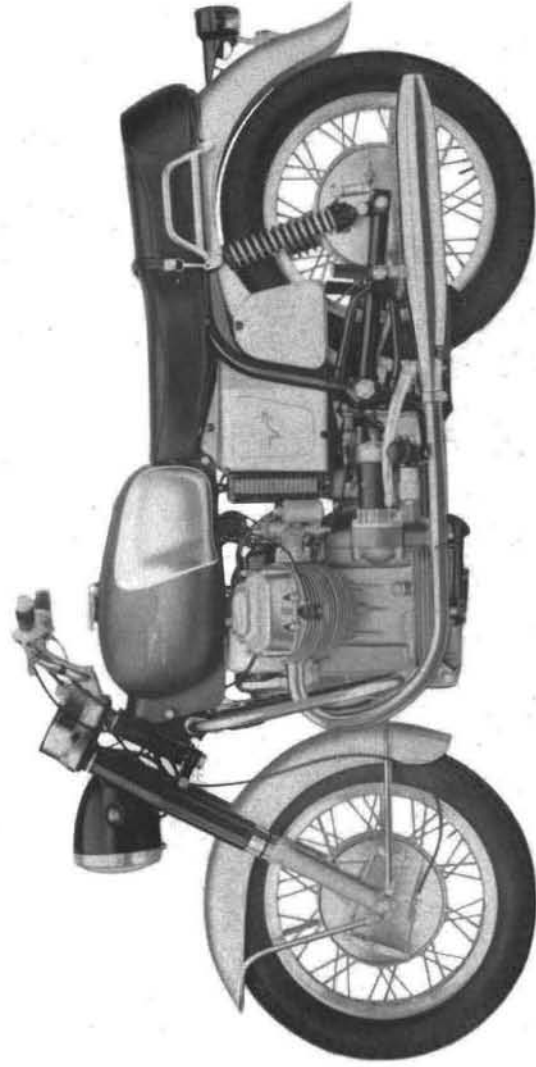

Fig. 2 - Left view

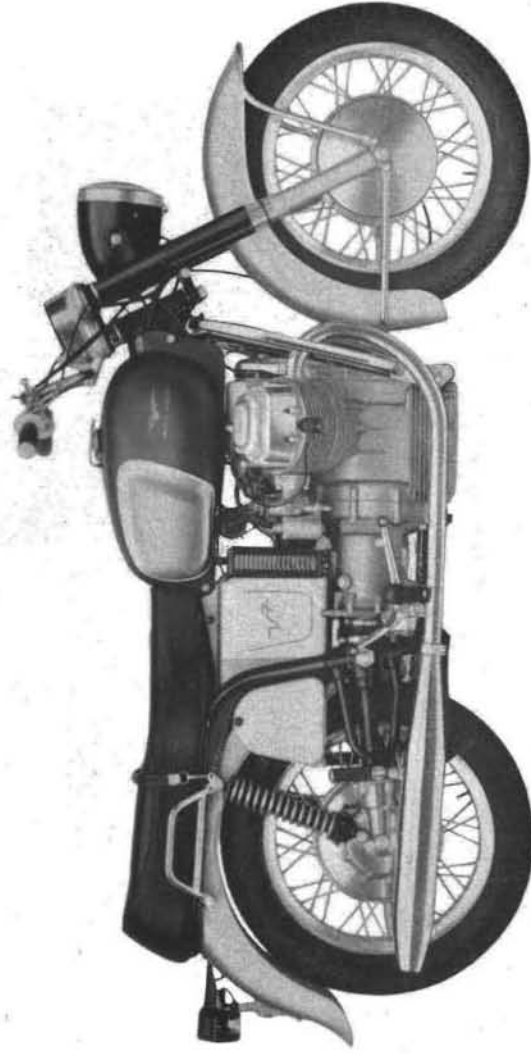

Fig. 3 - Right view

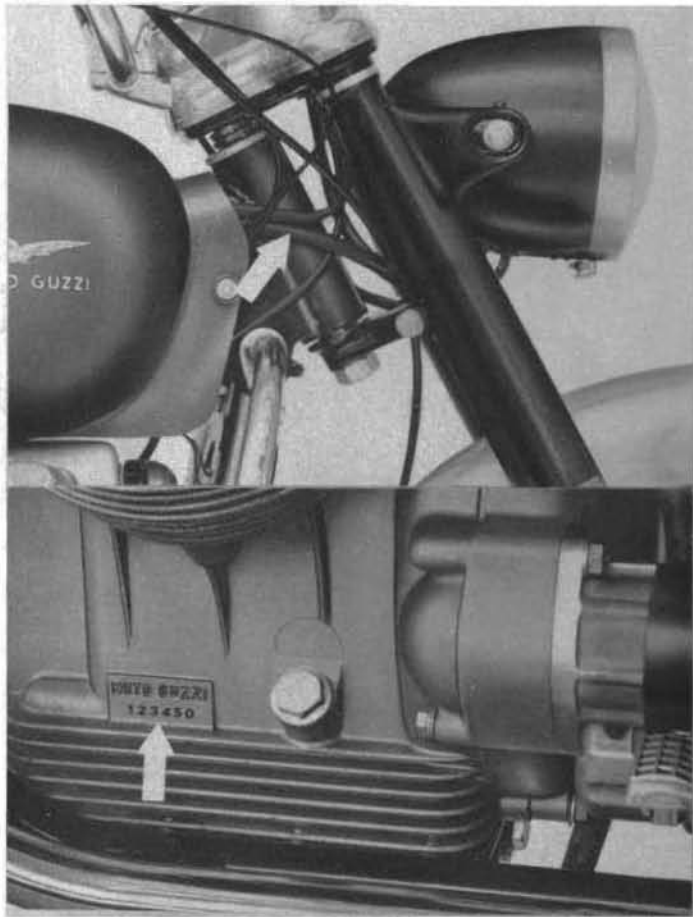

Fig. 4

## IDENTIFICATION DATA

(See fig. 4)

Every machine is identified with a serial number which is stamped on the frame down tube and on the left hand crankcase cover.

## Ignition key

An ignition key and a duplicate are supplied with each machine. The number should be recorded. In case of loss, the key number should be reported to your dealer.

## TOOL KIT

(See fig. 5)

- 1 - Box wrench, 19/21/22 mm.
- 2 - Open ended wrench, 17/19 mm.
- 3 - Open ended wrench, 10/11 mm.
- 4 - Tappet adjusting wrench
- 5 - Box wrench, 8/9 mm.
- 6 - Allen key (5 hex)
- 7 - Box wrench, 10/14 mm.
- 8 - Universal pliers
- 9 - Adjustable wrench
- 10 - Screwdriver
- 11 - Ring wrench, 27 mm.
- 12 - Tool bag

## Spare parts

If replacements are required be sure that genuine Moto Guzzi parts are used. Failure to do so will absolve the Manufacturer from all guarantee liabilities.

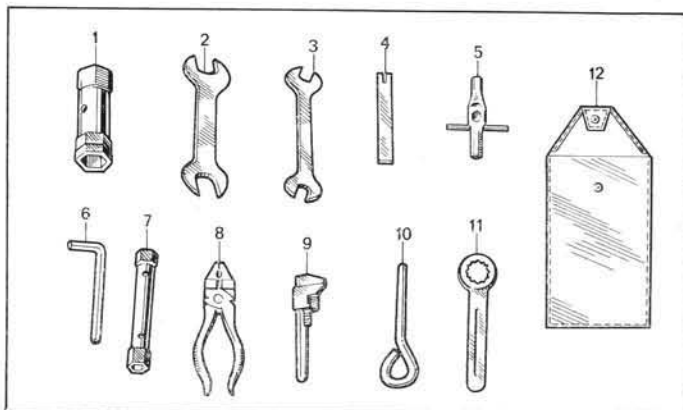

Fig. 5

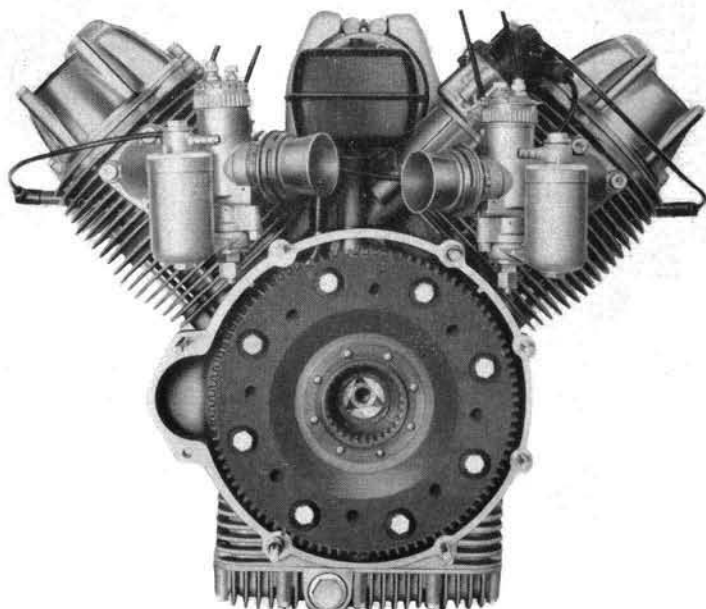

Fig. 5/1

## MAIN FEATURES

### ENGINE

(See fig. 5/1)

Cycle	: 4 strokes
Number of cylinders	: 2
Cylinder disposition	: « V » - 90°
Bore	: 80 mm. (3.149")
Stroke	: 70 mm. (2.755")
Displacement	: 703.717 cc. (42.93 cu. in.)
Compression ratio	: 9 to 1
Revs at max engine speed	: 6000 r.p.m.
Output at max engine speed	: 50 HP SAE
Crankcase	: in light alloy
Cylinders	: in light alloy, hard chromed bores
Cylinder heads	: in light alloy, hemispherical, with special cast iron inserted valve seats
Crankshaft	: steel construction
Crankshaft supports	: in special tin-aluminium alloy pressed in suitable housings
Connecting rods	: steel construction with AL-TIN alloy thin wall bearings
Pistons	: in light alloy

### Valve gear

O.H.V., push rod operated via the camshaft in the crankcase and gear driven by the crankshaft.

Inlet:

- opens 24° before TDC
- closes 58° after BDC



Exhaust :

- opens 58° after BDC
- closes 22° after TDC

Rocker clearance for valve timing :

- 0,5 mm. (.0196")

Normal rocker clearance (cold engine) :

- inlet 0.1 mm. (.00393")
- exhaust 0.2 mm. (.00787")

### **Carburation**

Both carburetors are gravity fed from the tank.

Carburetor Make :

type Dell'Orto S.S.I. (ringht and left)

### **Lubrication**

Pressure, by gear pump driven by the crankshaft.

Oil strainer in crankcase.

Normal lubricating pressure 2.5 - 3 kgs./sp. cm. (35.6 - 42.7 lbs/sp.in.)

(Controlled by relief valve)

Electrically controlled oil pressure gauge.

### **Cooling**

By air. Cylinder and cylinder heads deeply finned.

### **Ignition**

By battery with automatic advance Marelli distributor type S 123 A.

Initial advance: 10°.

Automatic advance: 28°.

Ignition timing 38° full advance.

Contact breaker gap: 0.42-0.48 mm. (.016-.018").

Spark plug: n. 225 in Bosch-Marelli scale or equivalent.

Plugs point gap: .6 mm. (.023").

Ignition coil: Marelli BE 220 D.

### **Starter motor**

Marelli starter MT 40 H (12 V - .7 HP) with electromagnetic ratchet control. Ring gear bolted on flywheel.

### **Exhaust system**

Dual exhaust pipes and mufflers.

## **TRANSMISSION**

### **Clutch**

Twin driven plates, dry type, located in the flywheel. Controlled by lever on left handlebar.

### **Gear box**

Four speeds, frontal engagement. Constant mesh gears. Cush drive spring incorporated. Separate case bolted on crankcase, operated by rocker pedal on the right hand side of the machine.

Engine-gearbox ratio: 1 to 1.352 (17-23)

Internal gear ratios:

- Low gear . . . . 1 to 1.812 (16-29)
- Second gear . . . . 1 to 1.25 (20-25)
- Third gear . . . . 1 to 0.956 (23-22)
- High gear . . . . 1 to 0.730 (26-19)

### **Secondary drive at rear wheel**

By homokinetic double joint cardan shaft.

Bevel layshaft gear-wheel ratio: 4.625 (8-37)

Overall gear ratios:

- Low gear . . . . 1 to 11.330
- Second gear . . . . 1 to 7.816
- Third gear . . . . 1 to 5.977
- High gear . . . . 1 to 4.564

<b>FRAME</b>	Duplex cradle, tubular structure.
<b>Suspension</b>	Telescopic front fork incorporating hydraulic dampers. Rear swinging fork with external adjustable springs.
<b>Tires</b>	4.00 x 18 front and rear, block type « high speed ».
<b>Tire pressure</b>	Front : — solo rider kgs./sq.cm. 1.5 (21 lbs/sq.in.) — with pillion » 1.5 (21 lbs/sq.in.) — solo rider » 1.8 (26 lbs/sq.in.) — with pillion » 2.0 (29 lbs/sq.in.)
<b>Brakes</b>	Twin leading shoes expanding type front brake operated by hand lever on the right handlebar. Large rear brake operated by pedal on left hand side of machine.
<b>Overall dimensions and weight</b>	— Wheelbase . . . 1.445 mts. (abt. 56.9") — Length . . . 2.230 mts. (abt. 87.8") — Width . . . 0.795 mts. (abt. 31.2") — Height (dry) . . . 1.050 mts. (abt. 40.3") — Minimum ground clearance . . . 0.150 mts. (abt. 5.9") Dry weight . . . . . 490 Lbs.
<b>Performance</b>	Maximum permissible speeds and gradients climbable in each gear, solo riding: Low gear abt. 66 kms/h ( 41 m.p.h.) Climbing ability 60% Second gear » 96 kms/h ( 59.6 m.p.h.) Climbing ability 34% Third gear » 120 kms/h ( 74.5 m.p.h.) Climbing ability 23%

High gear » 170 kms/h (106 m.p.h.)  
Climbing ability 14%

**Replenishments** Fuel tank 20 liters (7.57 US gls.) Petrol 98 NO (Regular octane) - Sump 3 liters (3¼ Quarts) Shell Multigrade 20/40 - Transmission 0.750 liters (1¾ Pints) Shell Spirax 90 E. P. - Rear wheel drive 0.300 liters (5/8 Pints) Shell Spirax 90 E.P. - Front fork dampers 0.160 liters = 5,4 oz USA « Shell Tellux 33 ».

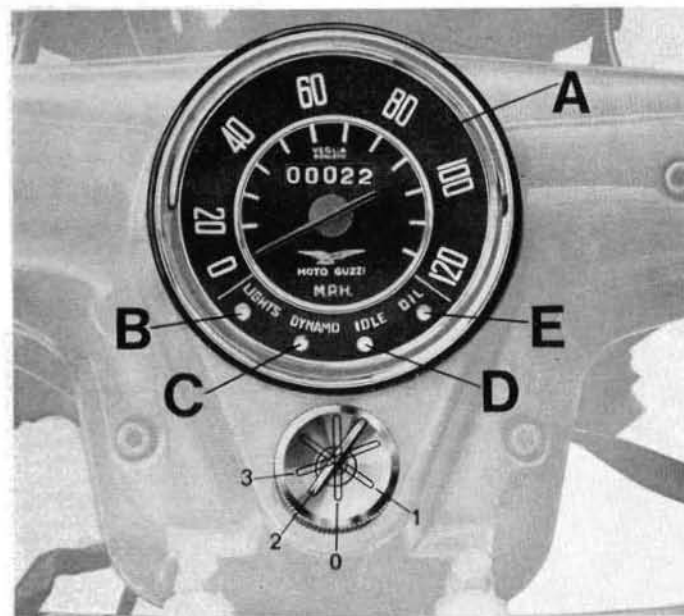

Fig. 6

## INSTRUMENTS AND CONTROLS

- 1 - Speedometer (See fig. 6) including
  - a) Mile calibrated clock.
  - b) High beam indicator red light;
  - c) Red warning light, ammeter. Indicating insufficient flow of current from generator for battery charge. Should go out when engine has reached a certain number of revolutions.
  - d) Orange warning light. Neutral indicator. Does not light up when any gear is engaged.
  - e) Red warning light. Oil pressure gauge. Goes out when there is sufficient oil pressure for engine lubrication.

- 2 - Ignition key switch (Automotive type). This controls the entire electric equipment and engine starting. This key has the function of an antitheft device (See fig. 6).

This key has four positions :

- « 0 » = Machine at standstill, key removable, all electrics switched off.
- « 1 » = Machine standing, key removable, parking lights on.
- « 2 » = Running position or machine ready to set out. All controls on. For daylight riding no other position is necessary. For night driving lever A on the left handlebar switch must be switched on.
- « 3 » = For starting only. The key returns automatically to position

2 when the engine has started.

### 3 - Clutch lever

It is located on the left hand handlebar and should be used only for starting and gear shifting.

### 4 - Twist grip throttle control

It is fitted on the right handlebar. Throttle is opened by turning towards the rider.

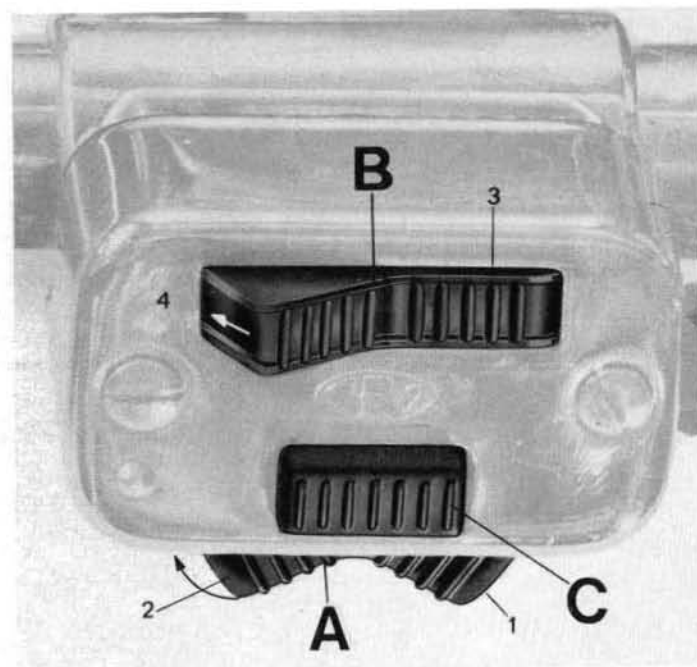

Fig. 7

- 5 - **Air lever for carburetors**  
Pulling this towards the rider opens the air and viceversa closes or chokes the air.
- 6 - **Front brake lever**  
It is located on the right handlebar.
- 7 - **Dipper switch and horn button** (see fig. 7). On left handlebar.  
Switch A:  
Position 1 = lights off  
Position 2 = lights on  
Switch B:  
Position 3 = low beam  
Position 4 = high beam  
Push button C = horn control.
- 8 - **Gearshift lever**  
Of rocking type, on right hand side of machine.
- 9 - **Rear brake pedal**  
It is located on the left hand side of the machine.

## RIDING INSTRUCTIONS

### Engine starting

Ensure there is sufficient oil in the tank and the crankcase oil is at correct level. Insert the ignition key and switch it on to position 2 (See fig. 6), ensuring that the oil pressure gauge, ammeter, and orange neutral indicator light up. (Don't forget that when this latter does not light up it means a gear is engaged).

Attempting to start an engine in gear is be dangerous, unless the clutch lever is kept fully disengaged, as with the firing of the engine the machine itself might start off.

On a cold engine, the air lever is set in the almost fully closed position and the gas opened about 3/4 turn. Turn on the ignition key fully to the right (See 3, fig. 6) to start the engine. When the engine starts release the key which will return to position 2 and open the air lever gradually.

### Important notice

Under no circumstances whatever must the engine be accelerated immediately after it is started. Allow it to idle for a few minutes in the hot season and for a longer time in cold weather in order that the oil may reach all lubricating points or until the cylinders start getting warm.

Even at very low temperatures, the engine should always start easily provided it is in good running order and sufficient thrust is imparted by the starter motor. If the engine does not start easily, do not persist in many attempts, but check carburation, ignition, battery charge, and ensure that the oil is not too heavy.

### Starting a hot engine

When starting a hot engine there is no need to close the air lever as this would richen the mixture and make starting difficult. When engine starting is difficult due to being overheated, open the throttle grip completely and at the same time switch on and off the ignition key from the « 3 » position.

### Starting, getting under way, and stopping the machine

Pull the clutch lever fully, engage bottom gear, release the clutch slowly, and turn on the gas simultaneously.

As soon as the engine picks up some speed, close the gas, pull the clutch and by downward toe pressure engage second speed. Release then the clutch lever rapidly (but not with a jerk) and turn on the gas once more. Third and high gears are likewise engaged by toe pressure.

### Starting

### On the way

In normal riding conditions, all tell-tale lights in the speedo should be off. If any one is lit up, there is either some fault in the system or oil pressure is insufficient. Steps must be taken immediately to locate and correct the fault.

The maximum speeds in each gear should never be exceeded, not even on steep downhill grades. Don't forget that by toe pressure you pass to a higher gear and by heel pressure to a lower gear (See fig. 8).

Before any gear is engaged, make sure the clutch is always completely disengaged. It is necessary to fully close the gas when you change up but it can be closed partially when changing down. To obtain fast and effortless gear shifts, always depress the pedal firmly but gently without stamping or jabbing vigorously.

The free position (neutral) is in between first

and second gear. To locate this position it is necessary to shift to bottom gear and then by slight toe pressure (half stroke). To feel for neutral position.

With the machine standing still and the engine running, the transmission should always be kept in neutral. Do not keep the clutch lever depressed even during the briefest stops. Always change to a higher gear rather than let the engine race.

### Stopping the machine

As soon as the machine stops, close the throttle, shift to neutral, turn the ignition key to the « 0 » position and remove (fig. 6).

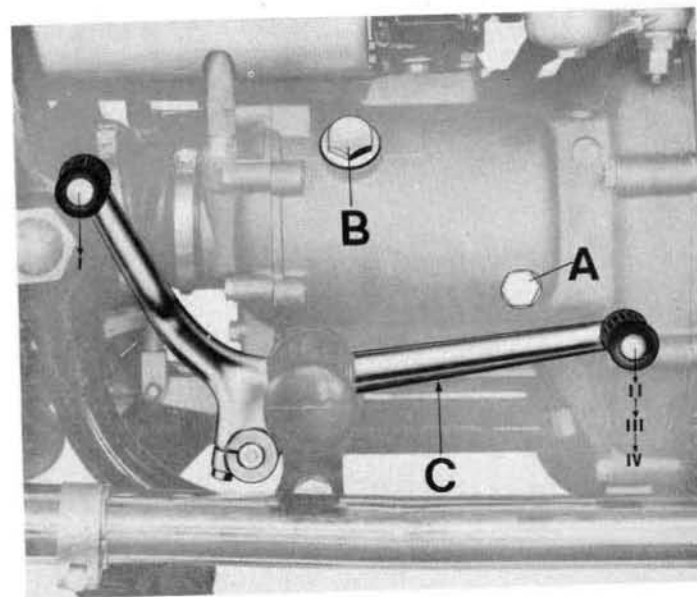

Fig. 8

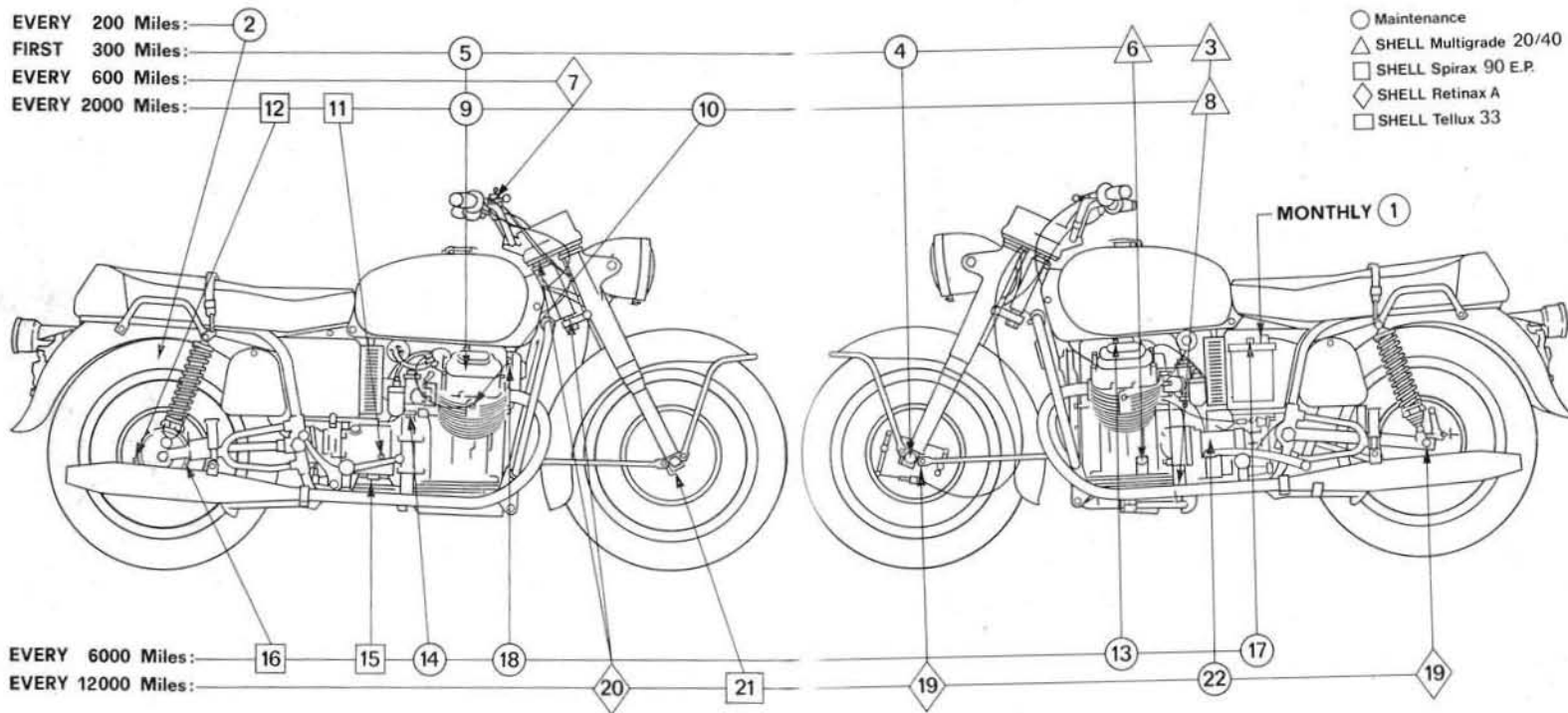

Fig. 9

## LUBRICATION AND GENERAL MAINTENANCE

(See Chart fig. 9)

### Monthly

- 1 - Check electrolyte level in battery (every 15 days in summer). See « Battery ».

### Periodically

- 2 - Check tire pressure with a gauge as noted on page 16.

### After the first 500 kms. (300 miles)

- 3 - Replace the crankcase oil. See « Engine lubrication ».
- 4 - Tighten all nuts and bolts.
- 5 - Check and adjust tappet play, if necessary. See « Tappet Adjustment ».
- 6 - Check and if necessary top up oil level in crankcase. Correct level is in between the minimum and maximum marks on the dipstick. See « Engine lubrication ».

### Every 1000 kms. (600 miles)

- 7 - Lubricate cable ends. See « Lubrication of clutch, front brake, and air cables ».

### Every 3000 kms. (1800 miles)

- 8 - Replace oil in crankcase. See « Engine lubrication ».
- 9 - Check tappet clearance. See « Tappet clearance ».
- 10 - Check and clean spark plugs. See « spark plugs ».
- 11 - Check oil level in gearbox and if necessary top up. See « Lubrication of gear box ».
- 12 - Check oil level in transmission box for lubrication of bevel gears. If necessary, top up.

### Every 10000 kms. (6000 miles)

- 13 - Clean petrol cocks and filters, carburetor filter, and fuel line to carburetors. See « Carburation ».

- 14 - Strip carburetor and check all parts. Using an air jet, clean out all ducts. See « Carburation ».

- 15 - Change gearbox oil. See « Lubrication of gear box ».

- 16 - Change transmission box oil. See « Lubrication of transmission ».

- 17 - Check cleanliness and tightness of all battery connections and smear them with vaseline. See « Battery ».

- 18 - Clean generator commutator using a clean cloth slightly moistened in petrol. See « Generator ».

### After the first 20000 kms. (12000 miles)

- 19 - Check condition of wheel bearings and if still efficient pack these with grease. See « Lubrication of wheel bearings ».

- 20 - Check condition of steering bearings and if still good, pack with grease.

- 21 - Replace oil in fork inner tubes. See Lubrication of fork.

- 22 - Clean starter motor commutator using a clean rag lightly moistened in petrol.

## SERVICING INSTRUCTIONS

### Lubrication of engine

(See fig. 10)

Using the oil filler dipstick (A), check the sump level every 500 kms. (300 miles).

Correct oil level is in between the minimum and maximum marks. This check should be made on a warm engine.

Every 3000 kms (1800 miles) change the engine oil (on a new or overhauled machine this change should be made after the first 500 kms.) (300 miles). The oil should be replaced when the engine is warm by unscrewing filler cap A and drain plug B. Allow all the old oil to drain, re-fit plug B, and introduce new oil. Quantity required: about 3 liters (3 $\frac{1}{4}$  quarts), oil recommendation: Shell Multigrade 20/40.

### Oil pressure relief valve

Under no circumstances should this valve be tampered with as it has already been calibrated at the factory for a pressure operation of 2.5/3 kgs./sq.cms. (35-42 lbs. sq. in.).

### Oil pressure gauge

The indicator light goes out when the pressure is sufficient to open the contact of the pressure operated solenoid. If this light stays lit, then the oil pressure is incorrect. In such cases, stop the engine and inspect all passages and oil lines to determine the cause and correct before running engine.

### Lubrication of transmission

(See fig. 8)

The oil in this box must be checked every 3000 kms. (1800 miles). The level is correct when the oil is flush with the plug hole. Change this oil every 10000 kms. (6000 miles).

This operation should be carried out a short time after a ride when the oil is warm and easily drained.

To change the oil proceed as follows: unscrew filler cap B, level plug A, and drain plug C under the box. When the old oil has drained and plug C re-fitted, introduce fresh oil through B until it starts to leak out from level hole A, when both plugs can be replaced.

Oil quantity required: abt. 0.750 liters

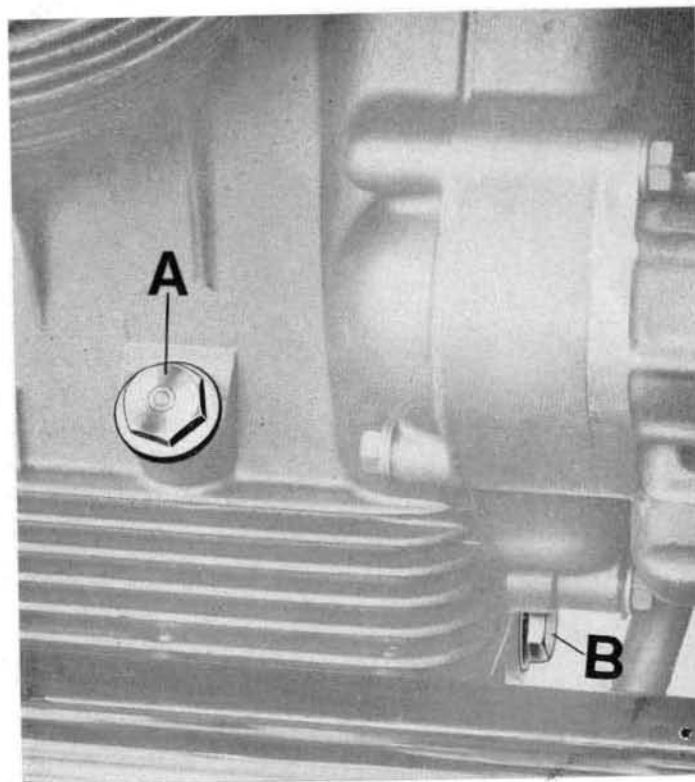

Fig. 10



(1¾ Pints).

Oil recommendation: Shell Spirax 90 E.P.

**Lubrication of rear wheel drive**  
(See fig. 11)

The oil level of this box should be checked every 3000 kms (1800 miles).

The oil should just skim the hole (A). Change the oil every 10000 kms. (6000 miles) and do this operation on a hot engine. Unscrew filler plug B, level plug A and drain plug C. When the old oil has drained refit plug C and introduce fresh oil until it starts seeping through hole A.

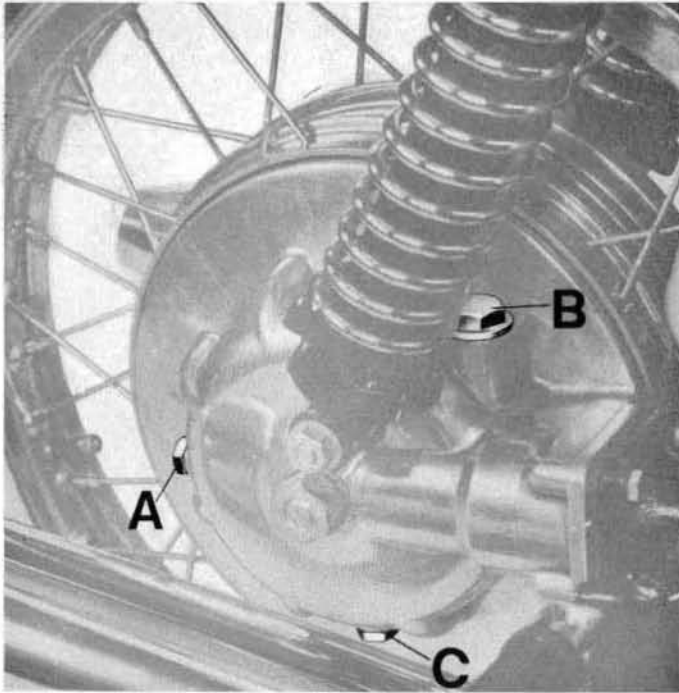

Fig. 11

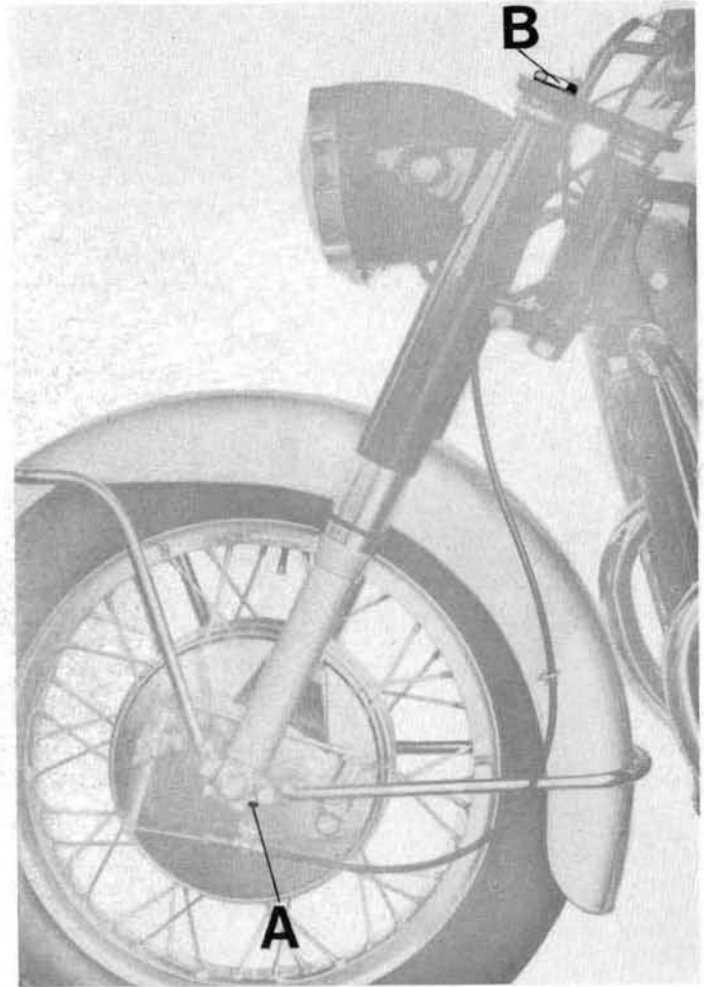

Fig. 12

### Lubrication of front fork and hydraulic dampers

(See fig. 12)

### Lubrication of bevel gears in steering

### Lubrication of wheel bearings

### Lubrication of control cables

### Lubrication of rear fork bearings

Quantity required: about. 0.300 liters (5/8 pint).

Oil recommendation: Shell Spirax 90 E. P.

Every 20000 kms. (12000 miles), change the oil in the fork tubes. Proceed as follows: Remove the drain plug and washer (A) and plug B. When the oil has drained, and drain plug A replaced introduce fresh oil through B. Quantity of oil for each fork tube: about 0.160 liters (5,4 oz). Oil recommendation Shell Tellux 33.

Every 20000 kms. (12000 miles) check condition of the steering bearings and pack with Shell Retinax A grease.

Every 20000 kms. (12000 miles) check the condition of these bearings and pack with Shell Retinax A grease.

Every 1000 kms. (600 miles) clean the cable ends and lubricate with Shell Retinax A grease. Actuate the levers several times to allow some of the grease to enter into the casings.

At the time of a general overhaul it is well to inspect these bearings to ensure there is sufficient grease. Grease recommendation: Shell Retinax A.

## CARBURATION

### Filters and fuel lines

Every 10000 kms. (6000 miles) or at any time when fuel flow is irregular, the fuel line and filters should be inspected and cleaned. Ensure the lines are not obstructed and that the tap and carburetor filters are perfectly clean.

These are best cleaned in a petrol bath and dried off with compressed air. Ensure that

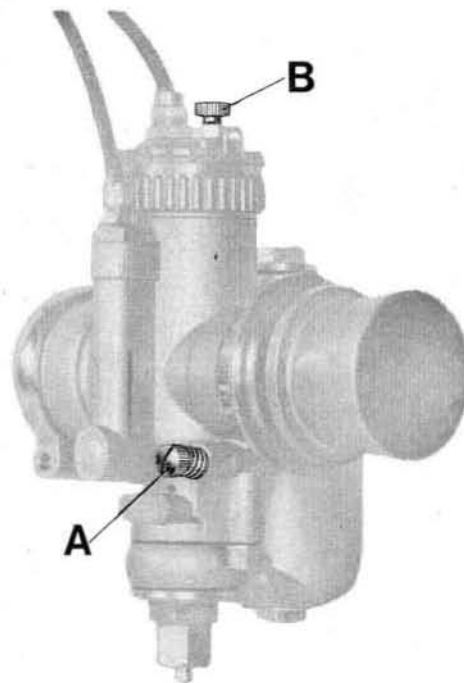

Fig. 13

## Carburetor

the lines have not hardened at their connecting ends. In such case, the lines should be replaced with original equipment.

This model is fitted with dual control carburetors type S.S.I. (right and left).

Every 10000 kms. (6000 miles), the carburetor bowls should be cleaned out thoroughly and all carburetor ducts blown through with compressed air. Air should also be used to clean the jets as the use of wire or needles might alter the size of the jets, and so upset carburation efficiency.

## Standard carburetor settings

Choke . . . . .	100
Throttle slide . . . .	265
Atomizer . . . . .	120
Main jet . . . . .	55
Pilot jet . . . . .	M14 III notch from top
Needle . . . . .	29 mm. (1.14")
Floater . . . . .	14 grams ( $\frac{1}{2}$ ounce)
Idling screw open	$\frac{3}{4}$ turn

## Adjustment for idling speed (See fig. 13)

This adjustment must always be made on a hot engine.

Screw in or out the horizontal screw (A) which is the idle adjusting screw to richen or weaken the mixture. Screw B on the top of carburetor is the throttle valve adjusting screw.

To adjust, proceed as follows :

1. Ensure both idle adjusting screws are open about  $\frac{3}{4}$  of a turn.
2. Using the twist grip, open the throttle to about  $\frac{1}{4}$  throttle and start engine.
3. Adjust the throttle cables to a position that both cylinders are firing even and with the same amount of exhaust pressure.
4. Release the twist grip and adjust the

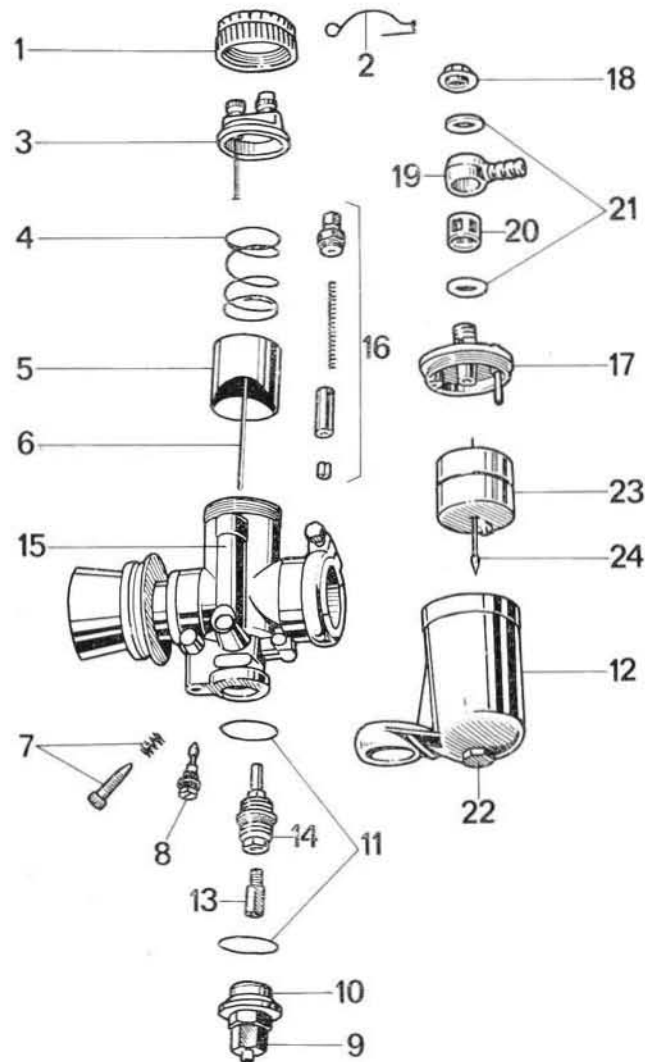

Fig. 14

throttle valves, using the adjustment (B) on top of the carburetor to the desired idle speed and at a position where both cylinders are firing evenly.

5. Adjust the idle screw (A) to obtain the best mixture. It is best to remove the sparkplug wire on the opposite cylinder. After resetting the idle screws, readjust the throttle valves for the desired engine speed, if necessary. If it is necessary to close the air or idle screw completely, the pilot jet is too small, and one having a larger orifice should be fitted. If it is necessary to open the idle screw considerably more than 3/4 of a turn, the pilot jet is too large and one with a smaller orifice should be fitted.
6. Recheck to ensure both throttle valves are synchronized to open at the same time, and lock the cable adjusters and throttle valve stop bolts in position.
7. Precise adjustments are best obtained when using an electric tachometer.

### Determining correct size of main jet

When the mixture is too weak, change to a larger jet. If too rich, a smaller size main jet should be fitted.

To determine the correct size of the main jet, proceed as follows:

- 1 - If on opening the throttle the engine is slow in picking up speed and the machine does not go faster or decelerates and shows a tendency to backfire, and on opening the air lever there is some improvement, then the mixture is too poor due to a too small main jet. In such case change to the jet size which will give the best performance.
- 2 - If on opening the throttle a duller exhaust tone is noticed and the engine ejects black

smoke, also if on slightly opening the air lever this condition accentuates, then the mixture is too rich and a smaller size jet should be fitted.

### Stripping of carburetor (See fig. 14)

Remove:

- Clamp 2 and lockring 1.
- Complete mixture chamber cover 3.
- Throttle slide spring 4, throttle slide 5 with taper needle 6.
- Air screw with spring 7.
- Pilot jet 8.
- Bowl cap nut 9, float chamber securing bolt 10, washers 11, float chamber 12, main jet 13, jet block 14.
- Carburetor body 15 and cable tensioning group 16.
- Float chamber with floater 17, adaptor cap nut 18, adaptor 19, filter 20, and washers 21.
- Plug 22 and floater 23 with needle 24.

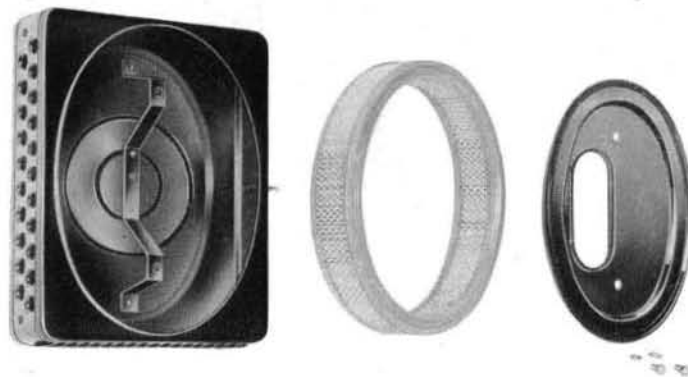

Fig. 15

After the carburetor has been stripped and all parts cleaned with an air jet, it is a good practice to inspect and clean the fuel filters and line from the tank.

### Air filter (See fig. 15)

This dry type replaceable filter is located in a suitable box on the frame.

Air to the carburetors is taken directly through a rubber sleeve from the air filter box. When the filter is dirty, replace it.

### Fuel tank (See fig. 16)

Whenever the machine is overhauled, the fuel tank, tap filters, tap ducts (A), adapters (B), and fuel lines (C) should be thoroughly cleaned as well. The tank is best cleaned when removed from the frame.

Pour some petrol in it and shake vigorously.

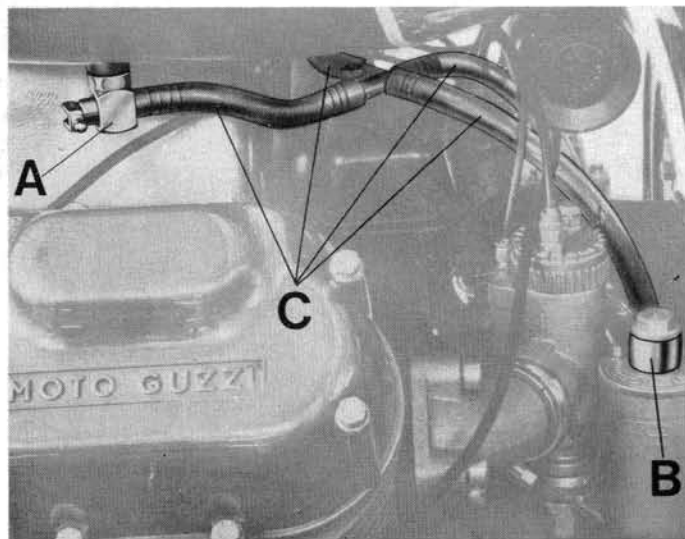

Fig. 16

Drain from the top opening to carry away any sludge or scaling which may have deposited at the bottom of the tank. The filters are best cleaned with petrol and compressed air.

### Mufflers

Internal cleaning of the mufflers is carried out as follows: fill the mufflers with a solution of boiling water and caustic soda (20%) and allow them to stand for about an hour when they can be emptied and rinsed out with boiling water while shaking vigorously.

This operation should be carried out on both mufflers.

## VALVE GEARING

### Tappet clearance (See fig. 17)

Every 3000 kms (1800 miles) or any time valve operation is too noisy, tappet clearance should be checked.

Adjustment must be made when the engine is cold with the piston at TDC and both valves closed, while the cylinder is on its compression stroke.

Using the wrench supplied in the tool kit, undo nut A and screw in or out screw B. Correct clearance is:

- inlet valve 0.1 mm. (.0039")
- exhaust valve 0.2 mm. (.0078")

Use a feeler gauge to check this clearance. When this is excessive, there will be noisy valve operation.

If it is less, the valves may not close fully thus causing compression loss, burnt valves, overheating of the engine, etc.

On a new engine, this adjustment must be made after the first 500 kms. (300 miles).

### Valve timing

The engine is timed when the gear are set as shown in « A and B » (fig. 18).

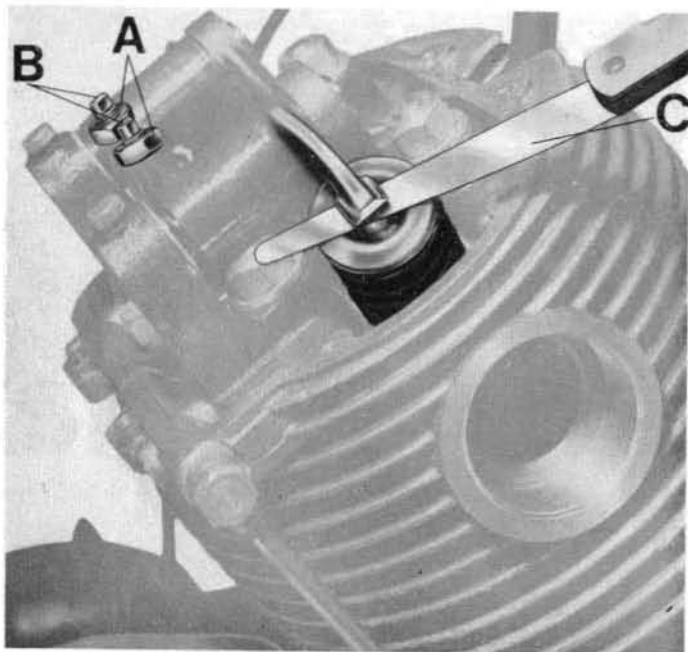

Fig. 17

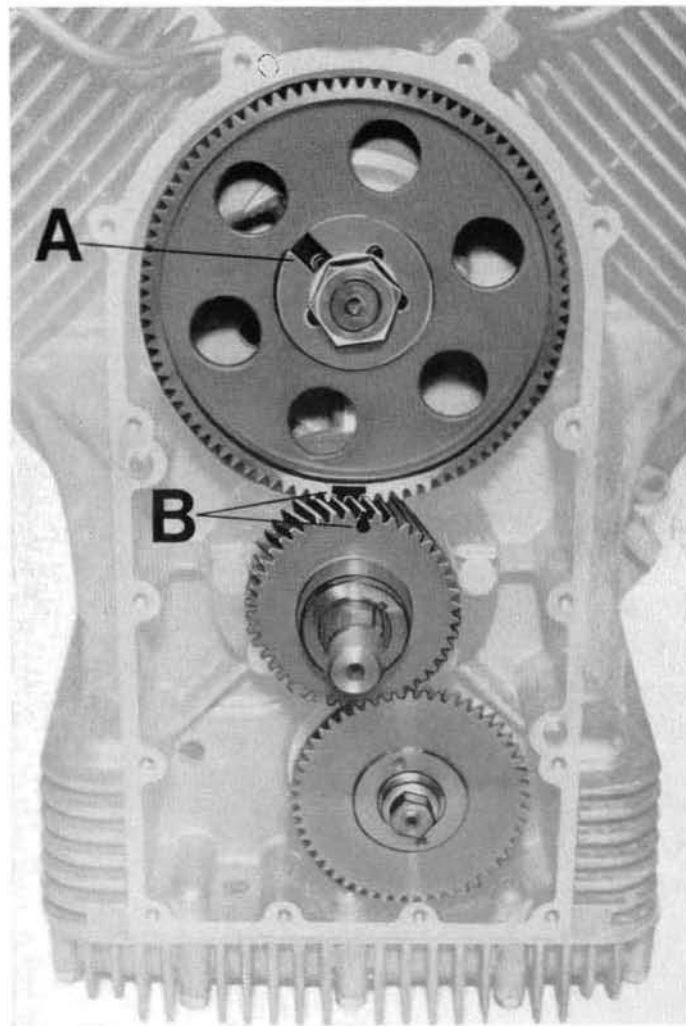

Fig. 18

## IGNITION

### Distributor (See fig. 19)

Every 10000 kms or so (6000 miles) the cam felt pad should be lubricated with a few drops of oil and the contact points inspected to ensure of their cleanliness. If dirty or greasy, clean them with a petrol soaked cloth. Correct contacts gap is 0.42-0.48 mm. (.016-.018"). If they need adjusting, loosen screw B which secures the fixed contact plate and move this to the position which will give the correct gap. The contact points should be changed when necessary.

### Spark plugs

Every 3000 kms. (1800 miles) check the gap which should be 0.6 mm. (0.23"). Check also the H.T. leads and replace as necessary. The spark plugs can be cleaned with petrol and a wire brush.

In fitting the plugs, make sure they are started by hand for a few turns and complete the operation by means of the plug wrench in the tool kit. To prevent thread stripping do not overtighten.

### Ignition timing

Remove generator belt cover. Check that the distributor contact points are  $0.42 \pm 0.48$  mm. (.016-.018") apart. Ensure the left cylinder (2) is on its compression stroke i.e. with both valves closed.

Rotate the generator pulley on the crankshaft till the slot on it is opposite the mark traced on the crankcase (See A, fig. 20) which is located in a  $10^\circ$  advanced position to the TDC arrow indicator also engraved on the crankcase. The points should start to open in this position and to ensure that they do so use a timing light which will light at the

exact time the points start to open. If the points open before or after the specified mark, slacken distributor securing bolt C

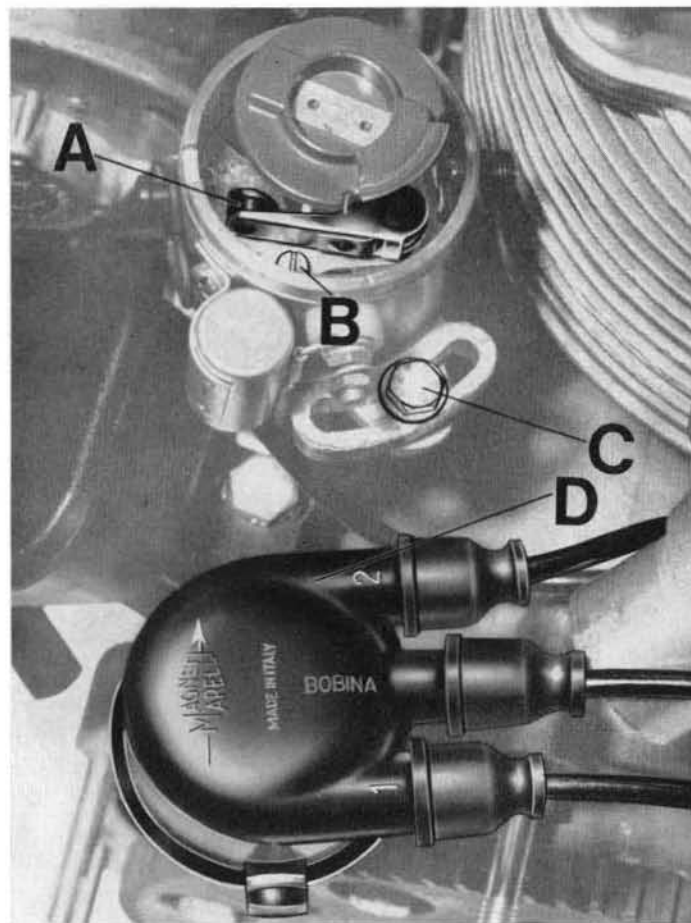

Fig. 19

(fig. 19) and turn the distributor to the right or left to the position in which the points start opening at the proper time.

The number of the cylinders is marked on the distributor cap as follows: right cylinder n. 1 left cylinder n. 2, coil = bobina. See D fig. 19.

## ADJUSTMENTS

### Generator belt

After long service, the belt may slacken and slip and in such case it should be tightened. Normal belt slack is 1 cm per 10 kgs (.39"/21 lbs.). The belt is tightened as follows:

- Unscrew bolt C which secures the outer half-pulley to the hub;
- remove the external half-pulley;
- remove one or more spacing collars to reduce the width of the race;
- if more than one collar is removed, fit these up at the front and rear end of the pulley.

Refit the outer half-pulley tightening up its 3 securing bolts (C).

### Clutch lever (See fig. 21)

This lever should be adjusted when the free movement at the handlebar is more or less than 4 mm (1/8"). Slacken thumb screw B and screw in or out adjuster A to obtain the correct distance. Don't forget to re-lock thumb screw B.

If the distance is less, the clutch may slip causing the plates to wear out.

If the play is more, there may be incomplete disengagement of the clutch causing noisy gear shifting. This adjustment can also be carried out by slackening nut D and acting on adjuster C bolted on the frame.

### Steering (See fig. 22)

Looseness of the steering is remedied as follows:

Slacken locknut A and using suitable wrenches adjust lockring B just sufficiently to take up excessive play and then relock nut A, keeping a hold on lockring B. Do not forget that loose steering may cause wear of the taper bearings.



**Front brake lever**  
(See fig. 23)

Play at the handlebar end should be checked periodically. This lever is adjusted when there is about 20-25 mm. ( $3/4$  to 1") play at the handlebar before the linings contact the drums.

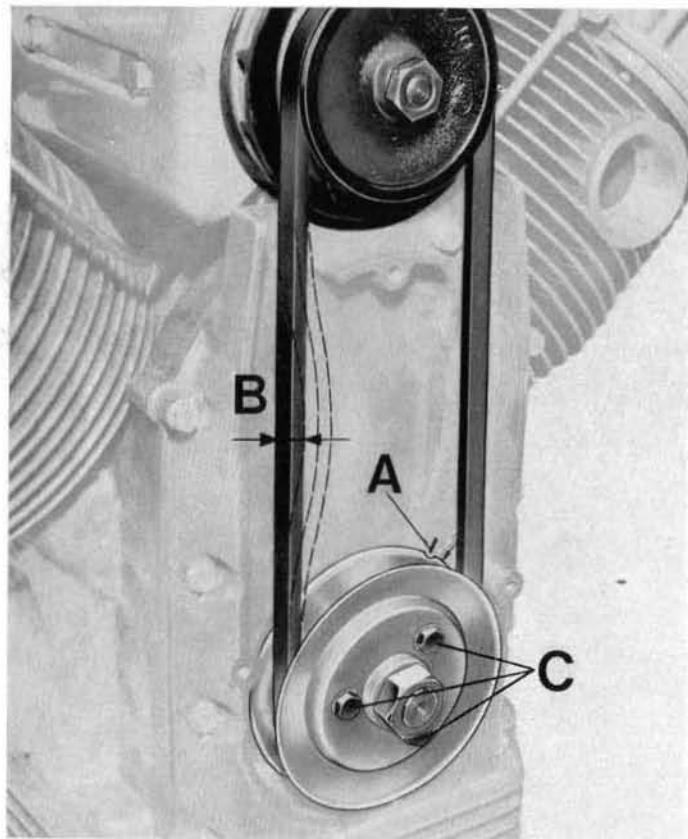

Fig. 20

**Rear brake pedal**  
(See fig. 24)

Excessive play is corrected either by acting on thumb screw B and adjuster A in fig. 21 or on adjuster C and nut D on the hub cover.

Adjustment of this lever is made by means of the thumb screw fitted on the threaded portion of the brake rod.

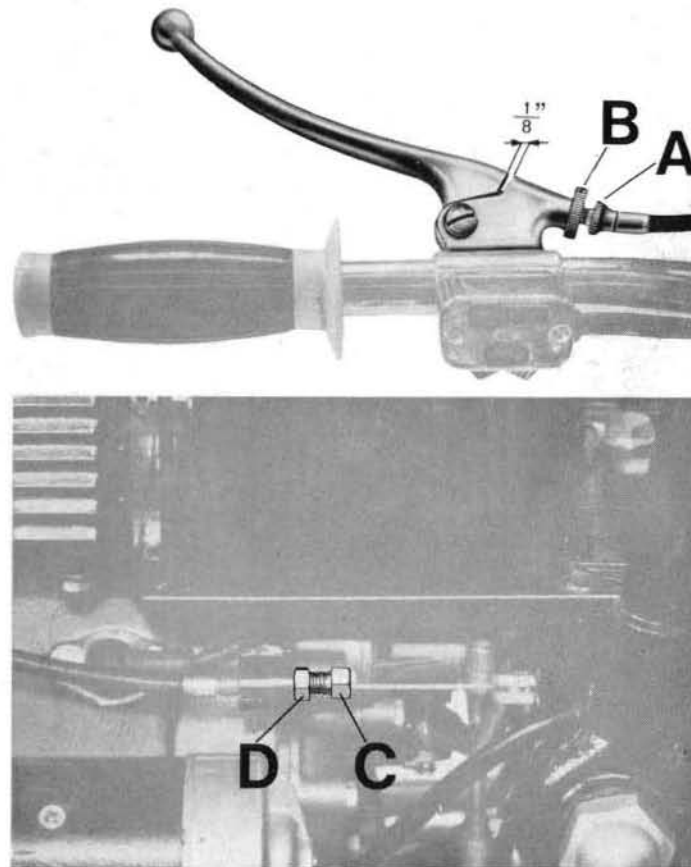

Fig. 21

Excessive play is taken up by screwing in this adjuster on the rod and the brake is properly adjusted when there is about 20-25 mm. ( $3/4$  to 1") play at the pedal end before the linings contact the drums. Generally, when this adjuster cannot be screwed in any more, it means that the lining may be completely worn out and has to be replaced.

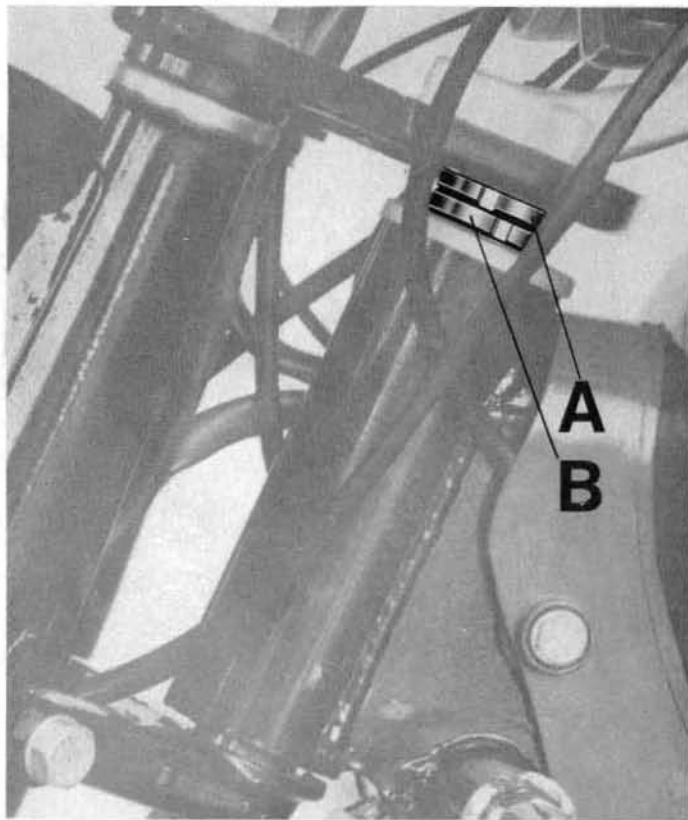

Fig. 22

**Rear suspension units**  
(See fig. 25)

The rear suspension has a 3 position adjustment: 1 normal load, 2 medium load, 3 heavy load, to suit the rider.

Change over to any position is made by

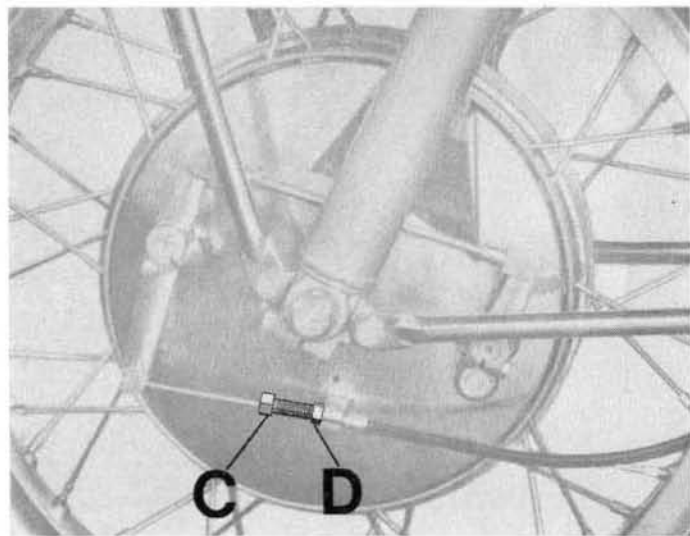
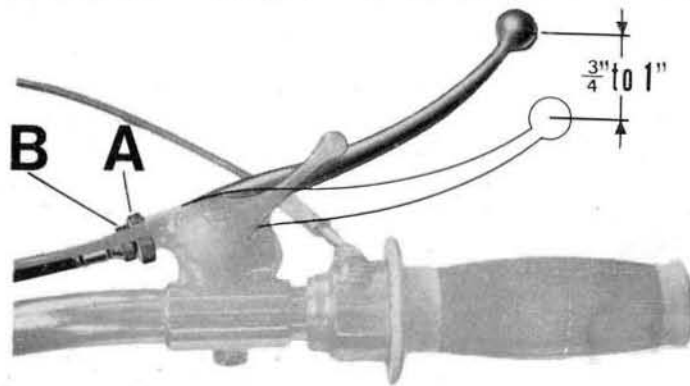

Fig. 23

turning knob A.  
In case of faulty damper operation, the complete unit should be replaced.

### Removal of front wheel (See fig. 26)

To remove front wheel disconnect the front brake cable from the brake lever on hub cover A and unscrew cable adjuster B. Undo nuts C and D which secure the wheel spindle to the right and left bottom fork members and take out the wheel spindle. Then push the wheel downwards just enough to free the brake block from the anchoring lug on the left bottom fork member and slide out the wheel.

**N.B. - In re-fitting dont forget to insert the brake block in its anchorage on the left fork member.**

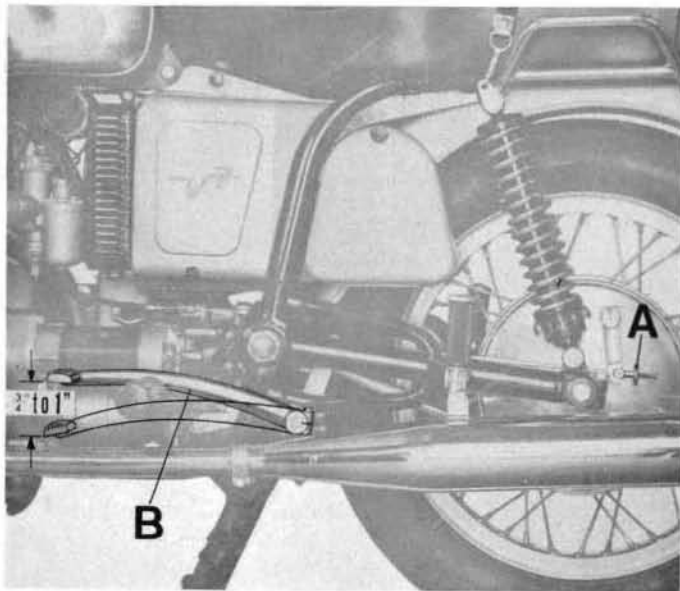

Fig. 24

### Removal of rear wheel (See fig. 27)

Unscrew nut A which secures the wheel spindle to the drive case and the nut which secures the stay to the brake block. Undo the rear brake adjusting thumb screw (B) and bolt C which locks the spindle to the rear fork and withdraw the spindle.

Pushing the wheel to the left will free the wheel from the sleeve. The wheel can now be taken out.

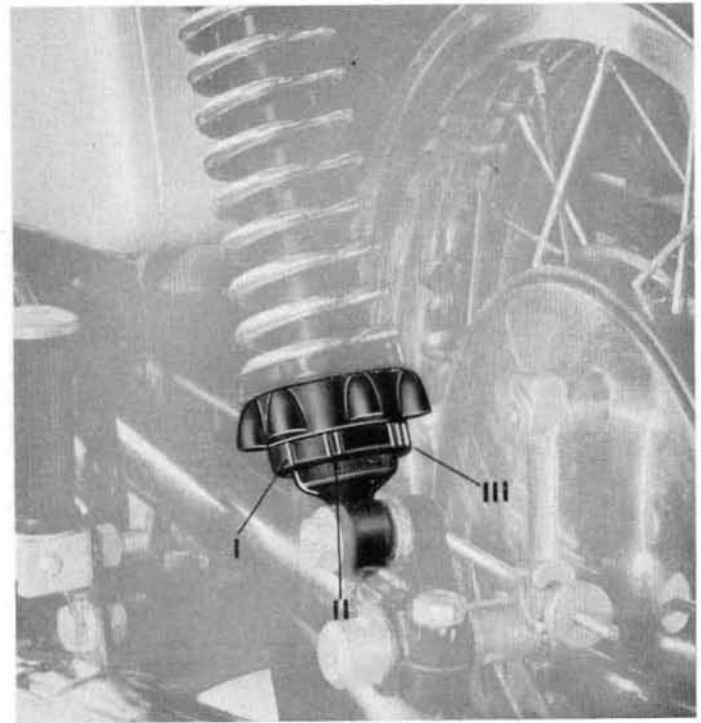

Fig. 25

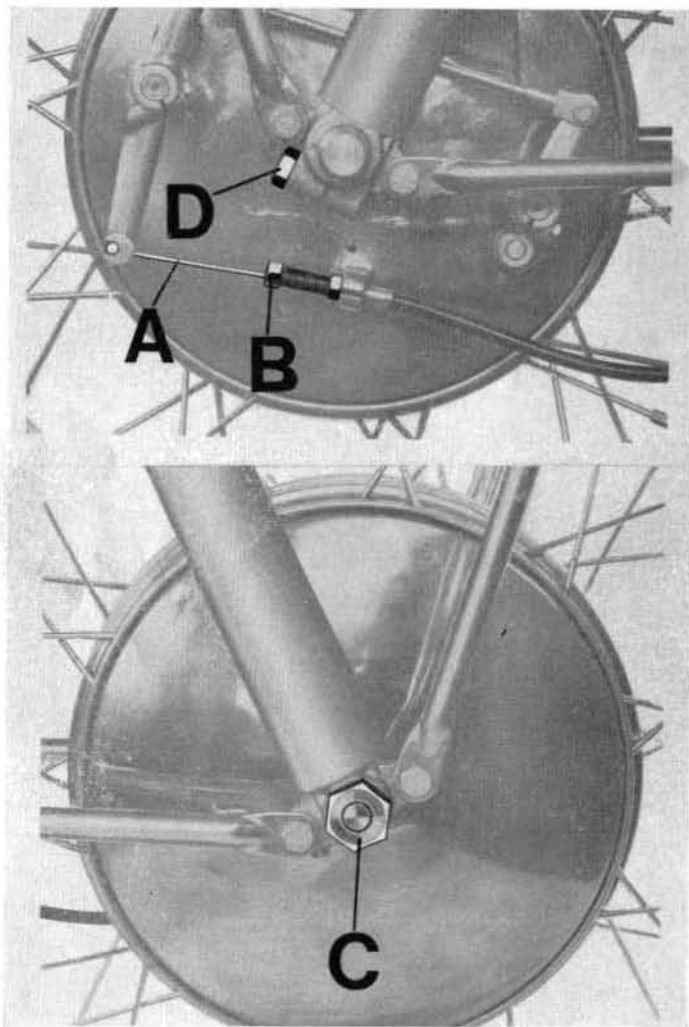

Fig. 26

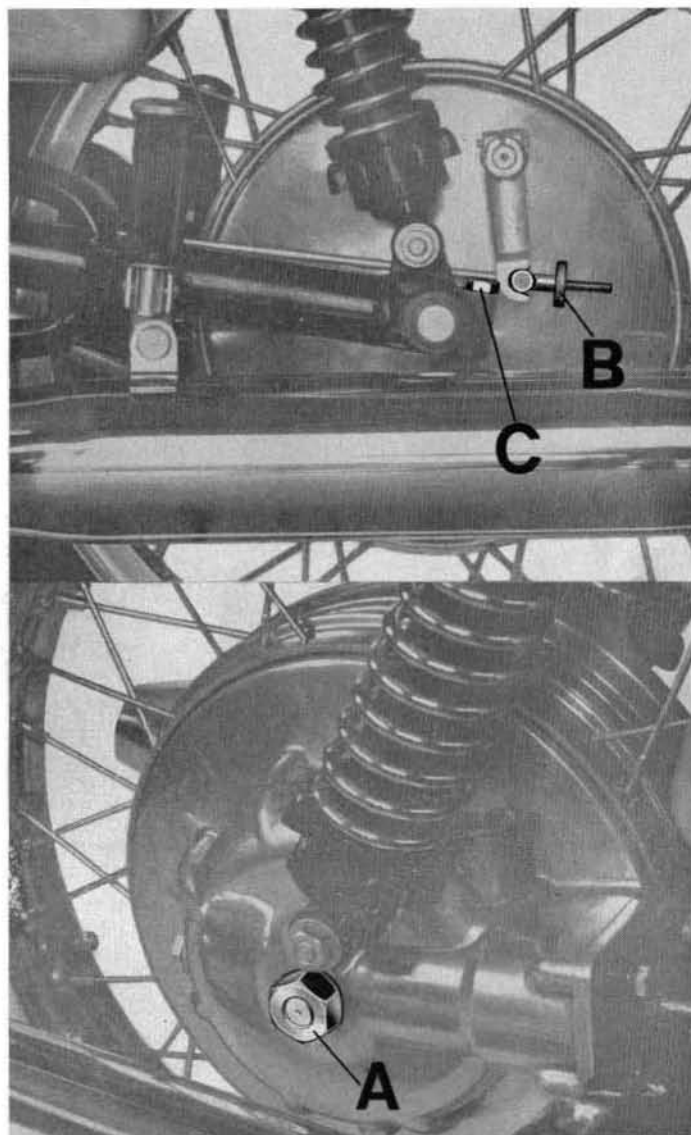

Fig. 27

## ELECTRICAL EQUIPMENT

(See diagram fig. 28)

### Battery,

The 12 V battery is centrally mounted and has a capacity of 32 Ah. It is charged directly by the generator.

Every 3000 kms. (1800 miles) check electrolyte level in each cell and if necessary top up with distilled water, using a glass or plastic funnel. Correct level is attained when the acid tops the plate separators by about 5 mm. (3/16"). Always top up with distilled water only and not with sulphoric acid as this remains while the water can evaporate.

Add distilled water to a cold battery and after it has not been in use for about 5-6 hours.

Make sure that no electrolyte flows over the top of the battery which must always be in a perfectly dry condition. If the level in any one cell is lower than in others, due to a crack, the battery should be immediately replaced.

Every 6000 miles check that all battery connections are in a perfectly clean condition and smear them with vaseline to prevent oxidation.

If the machine is to be kept out of use for any length of time, the battery should be given a refreshing charge every month or so.

Its condition is best checked with a small volume hydrometer at a room temperature of about 25° C (77° F). The battery is charged when the hydrometer reading shows 1.28 Sp. G. for normal service and 1.23 SP.G. for service in tropical conditions. An almost discharged battery shows a reading of about

### Generator (Marelli DN 62 M - 300 W)

1.16 SP.G. for normal service and about 1.1 SP.G. for tropical conditions.

Every 10000 kms. (6000 miles) clean the commutator using a clean cloth slightly moistened with petrol.

Copper or carbon dust which may have deposited in between the rotor blades can be removed by compressed air.

When cleaning the commutator check also the condition of the brushes and if chipped or worn replace them ensuring that they make good flat contact with the commutator, or else this may get damaged.

**N.B. - Replacement of brushes must be made with original Marelli parts and preferably by a fully qualified electrician.**

### Regulator unit (Marelli IR 50B)

The regulator is sealed to prevent being tampered with. In case of incorrect operation or failures, it should be sent for inspection to the makers or their agents. Replacements must be made with original Marelli units bearing the same part number.

### Starter motor (Marelli MT 40 H 12 V - 0.7 HP)

Clean its commutator every 20000 kms. or so (12000 miles). To clean it use a lightly petrol moistened cloth.

Carbon or copper dust between the rotor blades can be removed by compressed air. Check condition of the brushes and if any are worn or chipped they should be replaced. Ensure that they make good contact with the commutator surface in order to prevent it from getting damaged. Use only Marelli original parts and have this job done by fully qualified electricians.

**Horn** The 12 V horn does not require any adjustment since it operates by electrical contact. In case of irregular operation have it seen to by competent electricians.

**Light switch, dipper switch, and horn button** Does not require any adjustment but in case of faulty operation remove its cover and ensure that all wires are tightly screwed down.

**Headlight** This model fits a 168 diameter (6.6") sealed beam unit.

### Bulbs

Equipment	Type	Wattage (12V)
Headlight	Sealed beam insert	} 45
	168 mm. dia (.6")	} 40
Tail light	Two filament, round	} 20
		} 5
Speedometer	Round	3
Dimmed light indicator	Round	3
Ammeter	Round	3
Neutral indicator	Round	3
Oil pressure gauge	Round	3

**Tail lamp** Of approved type.

**Fuses** 4 fuses protect all the battery fed electrics i.e. ignition switch, speedometer and warning lights, stop light, and horn. If a fuse blows, trace an correct the cause, the replace with a similar fuse.

**Cables** Check these over occasionally and ensure of their perfect condition. Replace as necessary.

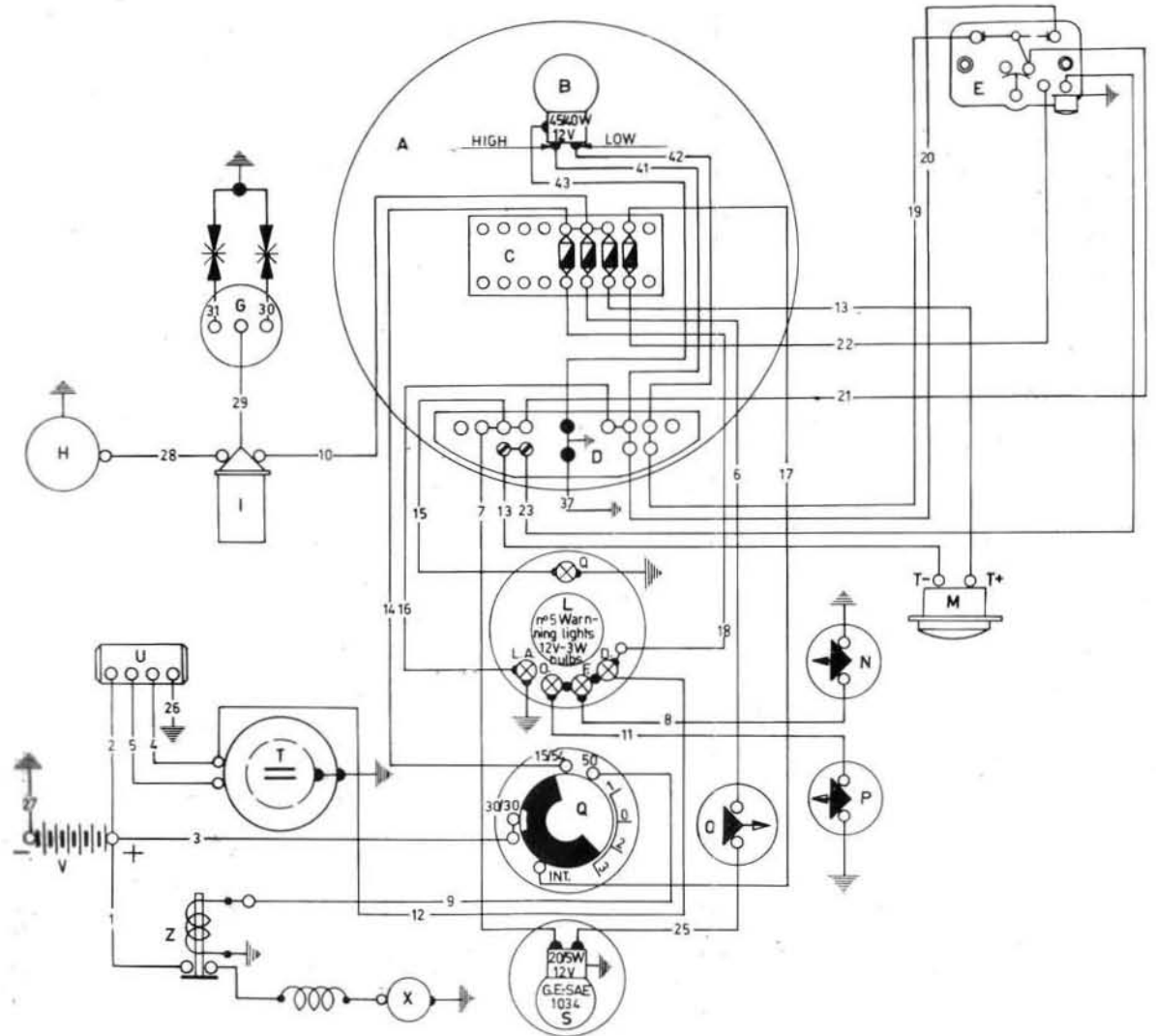

WIRING DIAGRAM Fig. 28

## KEY TO CABLE COLORS

1 - Black	: Battery V to starter motor relay Z
2 - Red	: Regulator U 51B+ to battery V +
3 - Red	: Battery V to ignition switch Q
4 - Grey-red	: Generator T to regulator U (D+)
5 - White	: Generator T to regulator U (DF)
6 - Black	: Terminal with fuses C to stop cut-out O
7 - Yellow	: Distributing block D to tail light bulb R
8 - Green	: Neutral cut-out N to warning light F on speedometer
9 - Brown	: Ignition switch Q (50) to starter relay Z
10 - Blue-black	: Terminal block C to H.T. coil I
11 - Grey	: Oil pressure cut-out P to speedometer L
12 - Red	: Generator T to warning light D on speedometer L
13 - Black	: Distributing block D to horn M (T—)
14 - Red	: Terminal block with fuses C to ignition switch Q (15/54)
15 - White	: Distributing block D to warning bulb Q in speedometer L
16 - Yellow-black	: Distributing block D to warning light LA on speedometer
17 - Brown	: Terminal block C to ignition switch Q (Int.)
18 - White-black	: Terminal block C to speedometer L
19 - Green	: Distributing block C to light switch E
20 - Green-black	: Distributing block D to light switch E
21 - Grey-red	: Distributing block D to light switch E
22 - Brown	: Terminal block C to light switch E
23 - Black	: Distributing block D to light switch E
25 - Black	: Stop light cut-out O to tail light bulb S
26 - Black	: Regulator U to earth
27 - Black	: Battery V to earth
28 - Black	: H.T. coil I to contact breaker H
29 - Black	: H.T. coil I to distributor G
30 - Black	: Distributor G to spark plug F
31 - Black	: Distributor G to spark plug F
37 - Black	: Headlight earth to frame
41 - Green-black	: Distributing block D to high beam filament B
42 - Green	: Distributing block D to low beam filament B
43 - Black	: Headlight bulb B to earth on distributing block D.

## WIRING DIAGRAM

A - Headlight
B - Main light bulb
C - Terminal block with fuses
D - Distributing block
E - Light switch and horn button
F - Spark plug
G - Distributor
H - Contact breaker
I - H. T. coil
L - Speedometer and warning light bulbs
M - Horn
N - Neutral indicator cut-out
O - Stop light cut-out
P - Oil pressure cut-out
Q - Ignition switch
R - Number plate and tail light
S - Plate illumination and stop light
T - Generator
U - Regulator
V - Battery
Z - Starter motor relay
X - Starter motor