



850-T3

ADDITIONS AND CHANGES FOR 850-T 3 MODEL

***PREMIER* MOTOR CORPORATION**

RAILROAD STREET & PLANT ROAD, HASBROUCK HEIGHTS, NEW JERSEY 07604
SOLE DISTRIBUTOR IN U.S. AND CANADA

MAIN FEATURES

ENGINE

2-cylinder 4-stroke
Cylinder disposition « V » 90°
Bore mm 83
Stroke mm 78
Displacement cc 844
Compression ratio 9,5
Output HP 68,5 SAE at 7.000 r.p.m.

Valve gear

O.H.V. push rod operated.

Carburation

2 Dell'Orto carburetors type VHB 30 CD (right), VHB 30 CS (left).

Lubrication

Pressure ,by gear pump.
Normal lubrication pressure $3,8 \div 4,2$ kp/sqcm (controlled by relief-valve).
Electrically controlled oil pressure gauge.
Wire gauze and cartridge oil filters.

Generator

Front (14 V - 20 A) on the mainshaft.

Ignition

By battery, with double contact breaker and automatic advance.

Ignition data:
Initial advance (fixed) 2°
Automatic advance 31°
Full advance 33°
Contact breaker gap mm $0,37 \div 0,43$
Spark plugs:
Marelli CW 7 L; BOSCH W 225; AC - 44 XL
Plug points gap mm 0,6
2 ignition coils.

Starting

Electric starter (12 V - 0,6 HP) with electromagnetic ratchet control. Ring gear bolted on flywheel. Starter botton, (START) right on the handlebar.

TRANSMISSIONS

Clutch

Dry type, multiplates, flywheel driven. Lever controlled from handlebar (left).

Primary drive

via the gearbox.
Ratio: 1 : 1,235 (Z = 17/21).

Gear box

Five speeds, frontal engagement, constant mesh gears. Cush drive incorporated.
Pedal controlled from left side of the motor-cycle.

Ratio:

low gear 1 : 2 (Z = 14/28)
2nd gear 1 : 1,388 (Z = 18/25)
3rd gear 1 : 1,047 (Z = 21/22)
4th gear 1 : 0,869 (Z = 23/20)
top gear 1 : 0,750 (Z = 28/21)

Secondary drive

cardan shaft (bevel gear set).
Ratio: 1 : 4,714 (Z = 7/33).
Overall gear ratio (engine/wheel):
low gear 1 : 11,643
2nd gear 1 : 8,080
3rd gear 1 : 6,095
4th gear 1 : 5,059
top gear 1 : 4,366

FRAME

Duplex cradle, tubular structure.

Suspension

Telescopic front fork incorporating sealed hydraulic dampers.
Rear swingin fork with externally adjustable springs.

Wheels

Spoked rims, WM 3/2,15 x 18 front and rear.

Tires

Front 3,50 H - 18 H or 100/90 H - 18 H.
Rear 4,10 H - 18 H or 110/90 H - 18 H.

Brakes

Front:

Hydraulic disc brake, (right) twin braking cylinder caliper. Hand lever controlled from the handlebar (R/H). Hydraulic transmission, free from rear braking system.

Disc dia. 300 mm.

Braking cylinder dia. 38 mm.

Master cylinder dia. 12,7 mm.

Twin hydraulic disc brake, (left) featured and dimensioned as above. Pedal lever controlled from the motorcycle (R/H). Hydraulic transmission, bound to rear braking system.

Rear:
 Hydraulic disc brake, twin braking cylinder caliper. Pedal lever controlled from the motorcycle (R/H).
 Disc dia. 242 mm.
 Braking cylinder dia. 38 mm.
 Master cylinder dia. 15,875 mm.
 Pedal control actuates both twin front (left) and rear brakes at the same time.

Max. height m 1,060
 Min. ground clearance m 0,150
 Curb weight kg 243

Dimensions and weights

Wheelbase m 1,470
 Max. width m 0,780
 Max. length m 2,200

PERFORMANCES

Maximum speed in each gear, solo riding:
 Gears Speed
 low gear km/h 71,837
 second gear km/h 103,502
 third gear km/h 137,339
 fourth gear km/h 165,329
 top gear km/h 195
 Fuel consumption: l. 6 x 100 km.

FUEL AND OIL CAPACITIES

GROUP OR PART	LITRES	TYPE
Fuel tank (Reserve l. 4)	24	Petrol 98/100 NO-RM
Sump	3	Agip SINT 2000 SAE 10 W/50
Gear box	0,750	Agip F.1 Rotra MP SAE 90
Rear drive box (bevel set lubrication)	0,230	Agip F.1 Rotra MP SAE 90
	0,020	Molykote type A
Front fork (each leg)	0,060	Agip F.1 ATF Dexron
Front and Rear Brakes		Agip F.1 Brake fluid SAE J 1703

CYLINDERS - PISTON - PISTON RINGS

(See fig. 182 and 183)

SELECTION OF CYLINDER DIA.

CLASS « A »	CLASS « B »	CLASS « C »
83.000	83.006	83.012
83.006	83.012	83.018

Cylinders must always be matched with pistons of same class.

SELECTION OF PISTON DIA.

CLASS « A »	CLASS « B »	CLASS « C »
82.968	82.974	82.980
82.974	82.980	82.986

Pistons must always be matched with pistons of same class.

PISTON RINGS (See fig. 183)

- n. 2 upper compression rings
 \varnothing 83 mm - thick. mm 1.478-1.490
- n. 1 intermediate oil scraper
 \varnothing 83 mm - thick. mm 1.478-1.490
- n. 1 lower oil scraper
 \varnothing 83 mm - thick. mm 3.978-3.990

— piston pin coupling:
 play mm 0.006 to a negative clearance of mm 0.004.

REMOVAL OF PIN FROM PISTON

After removal of circlips, use tool n. 13907860 (57 in fig. 181) to slide pin out of piston and con-rod small end.

PISTON PIN (See fig. 183)

- Length:
 mm 59.970-59.984 - \varnothing mm 22.000 \div 22.004.

CRANKSHAFT (See fig. 184)

The only change is in crankpin dia. (see following table):

CRANKPIN DIAMETER

SELECTION A-B	ORIGINAL \varnothing mm	OVERSIZE BEARING		
		0,254	0,508	0,762
« A » white mark on shoulder, flywheel side	44.008 \div 44.014	43.754 \div 43.766	43.500 \div 43.512	43.246 \div 43.258
« B » white mark on shoulder, flywheel side	44.014 \div 44.020			

Clearance between crankpin and bearing: min. 0.030 - max. 0.054.

Remark: Nitride treated crankshafts. For eventual adjustments send them back to « SEIMM·MOTO GUZZI ».

CRANKSHAFT BALANCING

Static balancing of crankshaft is obtained by applying a weight of kg 1.586 \div 1.616.
 Max. offset in axis parallelism: crankpin and main bearing pin must not overcome mm 0,02 at mm 40.

Timing data (referred to the clearance of 1,5 mm between rocker and valve) are the following (see fig. 185):

- inlet:
 opens 20° before TDC
 closes 52° after BDC
- exhaust:
 opens 52° before BDC
 closes 20° after TDC

TIMING DATA

(See chapter « Timing data »)

Normal rocker clearance (**cold engine**) mm 0.22.

CARBURETION

CARBURETTORS (See fig. 196)

N. 2 Dell'Orto Carburetors « VHB 30 CD » (right) « VHB 30 CS » (left).

Double controls:

- throttle control grip, right on the handlebar;
- starter control lever for starting a cold engine, located on left cylinder head cover « A »: starting position, « B »: riding position.

Note:

When the starter lever is in riding position « B » ensure that there is a clearance of about 3 mm between starter control cable ends and adjuster screws on both carburetors.

STANDARD CARBURETTOR SETTING

Choke	∅ mm 30
Throttle	40
Atomizer	265
Main jet	120
Idling jet	50
Starter jet	80
Needle	V9 (2nd notch)
Float	10 grams
Idling adjuster screw: open 1 turns and a half.	

ADJUSTING THE CARBURETION (See fig. 196)

Adjusting by hand.

This adjustment is made as follows:

- 1 Get the engine at its running temperature.
- 2 Screw idling adjusting screws « C » fully in; then screw them out by one turn and a half.
- 3 By means of your hands feel if pressure at exhaust tubes is the same. In case of differences, act on screw « D » of one carburettor until the pressure will be the same (idling speed will be kept at 900-1000 r.p.m. about; consequently it will be necessary to screw in the carburettor screw of the cylinder having a lower pressure or to screw out the carburettor screw of cylinder having a higher pressure).
- 4 Get the best carburetion for each cylinder by acting on screws « C » (this will be at the point where the r.p.m. increase slightly) then get idling speed according to point 3.
- 5 Disconnect one plug lead at a time and check that the engine stops after firing 5-6 strokes. If this does not occur, get it by proceeding as follows:
 - screw out screw « D » of the cylinder causing the engine firing more than 5-6 strokes;
 - screw in screw « D » of the cylinder causing the engine firing less than 5-6 strokes.

6 Adjust idling speed to 900-1000 r.p.m. by screwing in or out in the same quantity screws « D ».

7 After closing the throttle control grip, check that there is a clearance of mm 1 ÷ 1,5 between cable ends and adjuster screws « E ».

8 Check that both gas valves open at the same time by proceeding as follows:

- Turn slowly the throttle control grip and check by means of your hands that the pressure at exhaust pipes increases simultaneously. In case such increase is not simultaneous, adjust the carburettor of the cylinder in question by screwing adjuster « E » in (after loosening its counternut) until the pressure is the same for both pipes.

ADJUSTING BY MEANS OF A « VACUUM METER »

See proper instructions in chapter « Adjusting by means of a "Vacuum Meter" ».

AIR FILTER CARTRIDGE (See fig. 28)

Every 10000 km or so, replace the air filter cartridge « A ». It is located in a proper housing which is joined to the oil breather assembly under the fuel tank.

This replacement is better done by our dealers. To remove the filter « D » from the oil breather assembly « A » proceed as follows:

- lift the saddle and fix it by its proper rod;
- remove the tool box after unhooking its holding bracket;
- unhook the fuel tank, rear side, holding bracket and slip off the fuel tank (after closing the taps and disconnecting the fuel lines);
- disconnect electrical wiring from the battery and unhook its holding brackets;
- unhook the brackets holding springs « F » and take rubber manifold « G » out of intake on carburetors and oil breather;
- unscrew nut « B » fixing the oil breather to the housing « C » and slip off the oil breather « H » (after disconnecting it from intakes and lines). Remove now the filter « D » with bottom « E » from the oil breather.

After replacing the filter by a new original one, assemble the group by reversing the above operations.

ENGINE LUBRICATION

The 850-T3 fits an oil cleaner which in addition to a wire gauze filter is also provided with a filter cartridge.

This ensures an almost integral filtering before the oil passes in the pump and lubricating channels.

OIL SUMP (See fig. 186)

It fits:

- « A » filter cartridge, removable;
- « B » magnetic oil drain plug;
- « D » wire gauze filter;
- « E » oil pressure relief valve.

FILTER CARTRIDGE (See fig. 186)

To remove filter cartridge « A » from sump proceed as follows:

- undo plug « B » and let the oil fully drain;
- undo securing screws and remove sump « C » including:
 - filter cartridge « A »;
 - wire gauze filter « D »;
 - oil pressure relief valve « E »;
- undo filter cartridge « A » and replace it by another original one.

By this operation, wash and dry with a compressed air jet also wire gauze filter « D » before mounting sump « C » on the crankcase. Remember to replace gasket between crankcase and cover; fill up l. 3.5 of oil « Agip SINT 2000 SAE 10 W/50 ».

OIL PRESSURE RELIEF VALVE (See fig. 186)

It is screwed on the oil sump and is calibrated to allow an oil pressure of kp/sqcm 3.8-4.2 in delivery circuit.

Should pressure be higher than calibrated, this valve opens and bring pressure into fixed limits.

CHECKING THE OIL LEVEL

Every 500 km check oil level in the oil sump (level almost at max. mark on the dipstick welded to filler cap « A » (see fig. 20).

If level is lower top up with oil of same features. This checking will be carried out after engine running for a few minutes and dipstick « A » must be fully screwed.

Use oil « Agip SINT 2000 SAE 10 W/50 ».

SECONDARY DRIVE

cardan shaft (bevel gear set).

Ratio: 1 : 4,714 (Z = 7/3).

Overall gear ratio (engine/wheel):

low gear	1 : 11,643
2nd gear	1 : 8,080
3rd gear	1 : 6,095
4th gear	1 : 5,059
top gear	1 : 4,366

REAR DRIVE BOX

Checking the oil level (See fig. 199)

Every 3000 km (2000 miles) check that the oil level is nearly at the inspection hole « A ».

If the level is not correct, fill up with oil of the same type and features.

Changing the oil

Every 10000 km (6000 miles) change the oil in the rear drive box.

This operation should be carried out a short time after a ride when the oil is still warm and easily drained.

Remember to drain all the old oil before introducing fresh oil.

« A » inspection level plug.

« B » oil filler cap.

« C » oil drain plug.

Quantity required:

l. 0,230 of oil « Agip F. 1 Rotra MP SAE 90 »

l. 0,020 of oil « Molykote A ».

OIL LEAKAGE BETWEEN GEARBOX AND ENGINE UNIT

To detect oil leakages between gearbox and engine unit proceed as follows:

— first ascertain if the oil leaking outside comes from the gearbox or from the engine unit; this is quite easy to do by smelling the oil itself. As a matter of fact the oil coming from the gearbox smells bad and is more viscous (if this checking is done (cold-group) while the oil coming from the engine unit is less viscous and does not smell;

— if the oil comes from the gearbox, the leakage may be caused by the following:

1 Poor sealing between clutch pressure plate rod (14085700) and intermediate tube (12085901) in clutch shaft; see if the rod is very oily and slides freely into the clutch shaft (to ensure a proper sealing, the rod must force on the tube and this must force on the clutch shaft). In this case, it is advisable to check that the clutch plates are not oily.

2 Poor sealing of the ring (90403547) mounted on the gearbox, flywheel side; check ring resilience and wear, see if there is an oil drop under the ring itself. Should it be worn-out, check the surface of the clutch inner body contacting the ring in question. This surface must not be rough and must not show any crush or score.

3 If the clutch inner body (14081811) contains oil inside (where is locked the nut with washer securing the clutch inner body to the clutch shaft); check if the two sealing rings on clutch inner body and clutch shaft (90706235 and 90706235) have not lost resilience and efficiency.

4 Porosity in the gearbox; to check this, operate as follows: set the gearbox on a bench, the clutch housing side upwards (see Pict. 123); fill the clutch housing side with water and blow compressed air at 4 Kp/sqcm through the breather tube « B » (Pict. 123).

In case of casting porosity, small bubbles will be visible in the water. Seal the porosity by means of latex or special plasters (Araldite or Devcon).

If the clutch slides because of oil leakages between engine unit and gearbox and the oil passes between the clutch pressure plate rod and the intermediate tube and it is ascertained that the oil comes out from the engine crankcase, this may be caused by the following:

5 Oil leaking through the seal ring mounted on the crankcase flange, flywheel side; check ring resilience and wear, if worn-out inspect the crankshaft surface contacting the ring itself. This surface must be perfectly smooth.

6 Eventual porosity in the engine crankcase; for this checking set the engine on a bench, the flywheel side upwards, « see Pict. 122 » (remove first the flywheel from the engine unit) and fill it with water, blow compressed air at 7 Kpsqcm through the breather tube «A» (Pict. 122). In case of casting porosity, small bubbles will be visible in the water. Seal the porosity by means of latex or special plasters (Araldite or Devcon).

7 If the bands securing the rubber tubes of the engine oil breather are slackened, the oil may flow between the rubber and the metal tubes going between gearbox and engine unit.

8 See if the two lower bolts securing the flange, flywheel side, (12011400) to the engine crankcase are dry; should they be oily, set some « Teflon » tape on the bolt thread.

9 See that the lower stud bolt securing the gearbox to the engine unit is not oily where the reference bushing is located (left side); otherwise set some « Teflon » tape on the stud bolt thread.

OIL LEAKAGE FROM THE REAR WHEEL DRIVE

For this checking, operate as follows:

— fit the tool « C » (Pict. 124) on the drive box (this tool can be obtained from a used rear fork right arm by welding a plate with a valve, tyre inner tube type, on the arm top);

— set the drive box into a small basin filled with water and blow compressed air through the valve of the tool «C» (Pict. 124) at 4 kp/sqcm. In case of casting porosity, small bubbles will be visible in the water. Seal the porosity by means of latex or special plasters (Araldite or Devcon).

Check also that there is no oil leaking between the drive box and the lower pin securing the rear fork. Should this pin be oily, set some « Teflon » tape on the pin thread.

N. See pages 28-29 for pictures.

REAR SUSPENSION

The rear suspension of this model can fit two different types of shock absorber springs.

The former with 5 positions, adjustable by means of an incorporated lever.

The latter with 3 positions, adjustable by means of a wrench delivered with the tool kit.

Springs data

Free length: mm 270

Under kg 61 load: mm 230

Under kg 122 load: mm 190

Under kg 235 load: mm 116

FONT SUSPENSION

FRONT FORK

Sealed damper type. See chapter « Front Suspension and steering - Inspection and checking of the front fork ».

For inspection measures see drwg. 188.
Replenishing quantity: l. 0.060 of Agip F. 1 ATF Dexron per fork member.

WHEELS AND BRAKES

The 850-T3 fits n. 3 hydraulic braking discs. The features for master cylinders calipers and discs are at page 95.

For checking and overhauling of the above parts see from page 58 to page 63.

ADJUSTING THE FRONT BRAKE (RIGHT) CONTROL LEVER (See fig. 200)

After fitting a feeler gauge between floater in master cylinder and the end of the control lever get the correct play of mm 0,05 ÷ 0,15 by acting on screw « G ».

CHECKING BRAKE PADS WEARING

Every 5000 km (3000 miles) check brake pad thickness:

- new pad: mm 9;
- wear limit: mm 6 a.

If thick. is under the wear limit, it is necessary to replace the pads. After this operation has been carried out, do not drain the air but only operate the control lever on the handlebar « B » fig. 200 several times until the caliper pistons reach their normal position.

By the replacement of the pads, check the condition of the fluid pipes, should they be damaged, replace them immediately.

CHECKING THE BRAKE DISCS

(See L fig. 200 - 201)

The brake disc must be accurately clean, without oil, fat or other dirt and must not show any deep scoring.

In case of replacement or overhauling of the brake disc, it is necessary to check its wobbling. This checking is carried out by means of a proper gauge that must never read more than 0,2 mm.

Should wobbling be higher, carefully check the mounting of the disc on the hub and the play of the hub bearings.

Connection torque between disc and hub is kg/m 2,2 ÷ 2,4.

CHECKING THE FLUID LEVEL AND CHANGING THE FLUID IN RESERVOIRS (See fig. 200 - 201)

For a good working of brakes these directions are to be followed:

■ periodically check the fluid level (it has to be nearly at the gaiter « E » located in the fluid reservoir « A » on the right handlebar for the right front brake and under the right battery cover for both left front and rear brakes; it has

never to be lower than 8 mm under maximum level;

■ periodically top up the fluid reservoir « A » (if necessary) after loosening the cap « F »; take the fluid from an original container which must only be opened when using the fluid;

■ completely renew the brake fluid every 15.000 km (9000 miles) or at least once a year. The fluid pipes have to be always full and without air; a long and elastic movement of the control lever « B » evidences the presence of air inside them.

Use only fresh fluid in case of washing.

No alcohol is to be used for washing and no compressed air for drying up; use Trichloroethylene for metallic parts.

Fluid to be used: « Agip F. 1 Brake Fluid ».

AIR BLEEDING (See fig. 200 - 201)

This operation is required when the movement of the control lever on the handlebar is long and elastic because of the presence of air inside the braking circuits.

Operations are as follows:

Front braking circuit, right (See fig. 141)

■ turn the handlebar until master cylinder (fluid reservoir) « A » reaches the horizontal position;

■ if necessary, top up the fluid reservoir « A » (take care that during the air draining the fluid does not go 8 mm lower than the maximum level);

■ act on a caliper body only « C » at a time:

a) take out the rubber cover, then fit a transparent flexible pipe « H » on the drain plug « D »; the other end of this duct will be plunged into a transparent container « I » partially filled up with fluid of the same type;

b) loosen the drain plug « D »;

c) completely operate several times the brake control lever « B » on the handlebar, release it slowly and wait for a few seconds before operating it again. Repeat this operation until the pipe plunged into the transparent container emits airless fluid;

d) keep the control lever « B » completely drawn and lock the drain plug « D », then remove pipe « H » and mount the rubber cover.

If the air bleeding has been correctly carried out, a direct and efficient working of the fluid will be realized immediately after the initial idle movement of the lever « B »;

otherwise repeat the whole operation.

Rear and left front braking circuits (See fig. 202)

Proceed as by the right front braking circuit but with following changes:

- point c: completely operate the control pedal « B » at the R/H side of the motorcycle.
- point d: keep the control pedal « B » completely pushed down.

ADJUSTING THE CONTROL PEDAL FOR REAR AND LEFT FRONT BRAKES (See fig. 203)

- fit a feeler gauge between floater in master

cylinder and lever end « G » then get the correct play of mm 0,05 0,15 by acting on adjuster « A »;

- remove circlip, slip out pin and loosen counternut « B »; now screw in or out fork « C » until the ideal position of control pedal « E » is reached;
- re-fit pin and circlip.

After adjusting, loosen counternut « E » and adjust lever return stop screw « D ».

REMOVAL OF WHEELS

FRONT WHEEL (fig. 19)

- undo caliper « A » securing screws and remove caliper « A » with pipe from right fork cover.
- Undo wheel spindle lock nut « B » (left side).
- Undo screws securing fork covers to wheel spindle « C ».
- Slip off spindle « D »; care the position of spacer « E ».
- Lift the motorcycle so to disengage the braking disc (left wheel side) from caliper.

To re-assemble the wheel operate vice-versa. After re-assembling check clearance between pad and disc (See chapter «Checking pad wearing»).

REAR WHEEL

- Undo the screw securing left silencer to frame; and remove silencer from exhaust tube after undoing the screw securing its fixing clamp.
- Loosen nut « B » on the spindle, drive box side.
- Undo wheel spindle securing screw « C », on rear swinging arm.
- Take spindle « D » out of drive box, wheel hub and rear swinging arm.
- Take braking disc out of caliper « E ».
- Remove caliper from stop pin on rear swinging arm; place it on motorcycle lifting hand-grip.
- Lean the motorcycle to the right so to free the wheel « F » from rear swinging arm and drive box.

To re-fit the wheel operate viceversa.

Remember to fit caliper on the rear swinging arm (left) and to check clearance between pad and braking disc. (See proper chapter in section « Maintenance »).

ADJUSTING THE SPOKES

Check that all spokes are tightened and the wheel is correctly trued by proceeding as follows:

- spin the wheel and check its truing if necessary act on right or left spokes until the wheel turns properly. This checking has to be carried out after the first 500 km (300 miles) and later on, every 1500 km (900 miles) or so.

WHEEL BALANCE

To improve stability and decrease vibrations at high speeds the wheels have to be kept balanced.

Operations are as follows:

- after removing the wheel and checking spoke tightening and wheel truing suspend it on a fork;
 - spin the wheel lightly several times and see if it stops always in various positions, thus indicating a correct balance;
 - if one point of the wheel always stops at the bottom, put a balance weight on a spoke opposite that point.
 - repeat this operation until the wheel is correctly balanced then fix the balance weights to the spokes by means of pliers.
- Balance weights are available from our dealers in sizes of 15, 20, 30 grams. Normally, an imbalance of less than 15 grams does not affect the motorcycle stability.

TYRES

The tyre condition is of main importance as stability of motorcycle, riding comfort and even rider safety are depending on this factor. It is therefore quite advisable not to use tyres with tread lower than $1.5 \div 2$ mm respectively front and rear tyre.

A wrong tyre pressure can also affect stability of motorcycle and shorten type life.

Correct pressure is:

- front wheel: solo or with pillion kp/cm^2 : 2
- rear wheel: solo kp/cm^2 : 2.3
- with pillion: kp/cm^2 : 2.5.

These data are for normal riding (touring). In case of constant high speed or motorway riding increase tyre pressure $0,2 \text{ kg/cm}^2$.

MAINTENANCE, INSPECTION AND ADJUSTMENT OF DOUBLE CONTACT BREAKER

Contacts gap for 850-T3 model must be within mm $0,37 \div 0,43$.

For descriptions and adjustments see Chapter « Maintenance Inspection and Adjustment of Double Contact Breaker ».

CHECKING AND ADJUSTING IGNITION TIMING (FIXED ADVANCE)

See chapter « Checking and adjusting ignition timing » considering the following changes:

TIMING OF THE R/H CYLINDER

In this position, fixed advance mark 2 is 2° from P.M.S. (TDC) « D » and so at the commencement of the point separation (see A in fig. 164).

TIMING OF THE L/H CYLINDER

In this position fixed advance mark 3 is 2° from P.M.S. (TDC) « S » and so at the commencement of the point separation (see B in fig. 164).

CHECKING THE IGNITION TIMING (FIXED ADVANCE) WITH THE ENGINE ASSEMBLED ON THE MOTORCYCLE

(See fig. 165)

Only the mark « A.F. » (fixed advance) changes, namely 2° instead of 13° .

CHECKING THE IGNITION ADVANCE (FIXED AND AUTOMATIC) BY MEANS OF A STROBOSCOPE LAMP

(See fig. 64 and diagram fig. 188)

Ignition data

- fixed advance: 2°
- automatic advance: 31°
- full advance (fixed and automatic): 33°

CHECKING THE FULL ADVANCE (FIXED AND AUTOMATIC)

Changes:

- A. F. (fixed advance) 2° at 1000 r.p.m. ± 200 r.p.m.
- A. T. (full advance) 33° at 6000 r.p.m. ± 200 r.p.m.

SPARK PLUGS

The 850-T 3 model fits spark plugs:
Marelli CW 7 L; Bosch W 225 T 2; AC - 44 x L.
For other description see chapter « Spark Plugs ».

ALTERNATOR

Main Features:

Brand:	Bosch (G1 - 14V - 20A - 21")
Drive:	directly from crankshaft
Max. output:	280 W - 14 V
Max. amperage:	20
Charge starting:	1000 rpm
Peak charge:	10000 rpm
Rotation:	clockwise
(as seen from collector side)	

ELECTRICAL EQUIPMENT

Starter motor

Brand:	BOSCH DF - 12 V - 06 PS
Voltage:	12 V
Output:	0,6 HP
Current Intensity Ah.:	35
Pinion:	Z = 8 - mod. 2.5
Pinion rotation:	counterclockwise

ELECTRICAL TESTS

RUNNING	VOLTAGE	CURRENT	SPEED	TORQUE
Unloaded	11.5 V	$20 \div 40$ A	$6500 \div 8500$ rpm	—
Loaded	9 V	170 A	$3200 \div 3500$ rpm	kgm 0.15
Short circuit	8 V	$280 \div 360$ A	—	kgm 0.75

INSTRUMENTS AND CONTROLS

INSTRUMENT PANEL (U.S.A. MODEL) (fig. 4)

- 1 Mile counter.
- 2 Rev.-counter.
- 3 Orange neutral indicator. It lights when the gearbox is in neutral position. It may be well to make sure that this position is correct. In any case it is a good practice to pull the clutch before starting.
- 4 Red light indicating parking light on.
- 5 Red warning light. Oil pressure gauge. It goes out when the pressure is sufficient for normal engine lubrication. Should it not go out, the pressure is not correct; in this case the engine has to be stopped and suitable checkings are to be carried out.
- 6 High beam warning light (red).
- 7 Red warning light indicating insufficient current from the generator for battery charge. It must go out when the engine reaches a certain number of revolutions.

By day riding all warning lights are to be out. By night riding the parking warning light only and eventually the high beam warning light are on.

CHANGES FOR « EUROPE MODEL »

- 1 Km counter.
- 4 Green town driving light.
- 6 High beam warning light (blue).

By night riding the town driving warning light, only and eventually the high beam warning light are on.

KEY SWITCH (fig. 5)

The key has three positions.

- « 1 » (turned anticlockwise) Standstill, key removable.
- « 0 » (vertical) Standstill, key not removable.
- « 2 » (turned clockwise) Ready to start, all controls are in. Key not removable.

LIGHTING SWITCH (LIGHTS) (fig. 207 « A »)

Left, on the handlebar, 4 positions.

- « 1 » OFF Lights off.
- « 2 » PARK Parking light (USA).
Town driving light (Europe).
- « 3 » L Low beam.
- « 4 » H High beam.
- « 5 » To come back to position OFF press the button towards the lefts.

HORN, FLASHING LIGHT AND TURN SIGNAL CONTROLS (fig. 207 « B »)

Left, on the handlebar.

- « 6 » HORN Horn button.
- « 7 » FLASH Flashing light button.
- « 8 » OFF Turn signals button.
- « 9 » When turned to the right operates the right signals.
- « 10 » When turned to the left operates the left signals.

ENGINE STARTING AND EMERGENCY STOPPING (fig. 208)

Right, on the handlebar.

With the ignition key in position « 2 » in fig. 206 the motorcycle is ready to be started. To start the engine (see « A ») press the button « 1 » START.

To stop the engine (in case of emergency) turn the button in position « 3 » or « 4 » OFF.

After engine stopping reset key in position « O » fig. 206.

GEARSHIFT PEDAL (fig. 209)

On the left side of the motorcycle.

Low gear: pedal down.

2. 3. 4. and top gear: pedal up.

Neutral position: between low and 2 nd gear.

Before operating the gearshift pedal, the clutch lever has to completely pulled in.

TERMINAL BLOCK WITH FUSES (fig. 210)

It is located under the seat and holds n. 6 15 A fuses.

- « 1 » Rear stop light horn, flashing light.
- « 2 » Starting relay. Turn signals.
- « 3 » Warning lights. Oil-gen-N Low - High beam with warning light.
- « 4 » Parking or town driving lights - Instruments.
- « 5 » } Spare fuse.
- « 6 » }

STEERING LOCKING (« A » in fig. 211)

To lock:

- turn handlebar fully to the right.
- insert key into lock set, turn it anticlockwise and push it fully in, release it and take it off.

To release:

- insert key into lock set, turn it anticlockwise release it and take it off.

LIGHTS (Europe model)

HEADLIGHT

- high and low beam: bulb 45/40 W - 12 V
- town driving light: bulb 3 W - 12 V

TAIL LIGHT

- number plate lighting, parking light and stop light: bulb 5/21 W - 12 V.
- Indicators, instrument panel: bulb 1,2 W - 12 V.
Indicators, km and rev. counters: bulb 3 W - 12 V.

REPLACEMENT OF BULBS (fig. 212)

HEADLIGHT

- Undo screw « B », disconnect beam insert, slip off sockets and replace bulbs.

TAIL LIGHT

- Undo screws « C » securing reflector to tail light; push bulb inwards and turn it to the left at the same time, then slip it off.

TURN SIGNALS

- Undo screws « D » securing reflectors to signal lights; push bulbs inwards and turn them to the left at the same time, then slip them off.

By re-fitting of reflectors screw in uniformly, do not lock screws too much to prevent braking of same.

INSTRUMENT PANEL, KM AND REV. COUNTERS

- Slip off bulb sockets and replace bulbs.

HEADLIGHT BEAM ADJUSTING (fig. 212)

For a safe riding and not to trouble crossing riders, the headlight beam has always to be set a correct height.

For horizontal setting act on screw « A ».

For vertical setting undo connections « E » and shift the headlight by hand up or down in order to get the correct height.

The centre of the high beam must not be higher than 0,86 m measured at 3 m distance with motorcycle not on stand and rider on saddle.

WIRING DIAGRAM (Europe model)

(fig. 213)

- | | |
|---|--|
| 1 - Km counter | 22 - Alternator (14 V - 20 A) |
| 2 - Rev. counter | 23 - Starter motor relay |
| 3 - High beam indicator light | 24 - Starter motor (12 V - 0,7 HP) |
| 4 - Oil pressure indicator light | 25 - Clutch cable cutout |
| 5 - Neutral indicator light | 26 - Left rear turn signal |
| 6 - Town driving indicator light | 27 - Rear brake stop light |
| 7 - Generator charge indicator light | 28 - Number plate and town driving light |
| 8 - Low beam | 29 - Right rear turn signal |
| 9 - High beam | 30 - Flasher unit |
| 10 - Right front turn signal light | 31 - Oil pressure cutout |
| 11 - Left front turn signal light | 32 - Neutral position cutout |
| 12 - Engine starting and stopping switch | 33 - Terminal block with fuses (16 A) |
| 13 - Lighting switch | 34 - 3-way connector |
| 14 - Switch; turn signal, starting, horns, flashing light | 35 - 4-way connector (AMP) |
| 15 - Horns Power 7 A) | 36 - Contact breaker |
| 16 - Front brake stop light cutout | 37 - Coils |
| 17 - Flashing light relay | 38 - Ignition switch (3 positions) |
| 18 - Rear brake stop light cutout | 39 - 4-way connector (AMP) |
| 19 - Battery (12 V - 32 Ah) | 40 - 2-way connector |
| 20 - Regulator | 41 - Spark plugs |
| 21 - Rectifier | 42 - Town driving light, front |

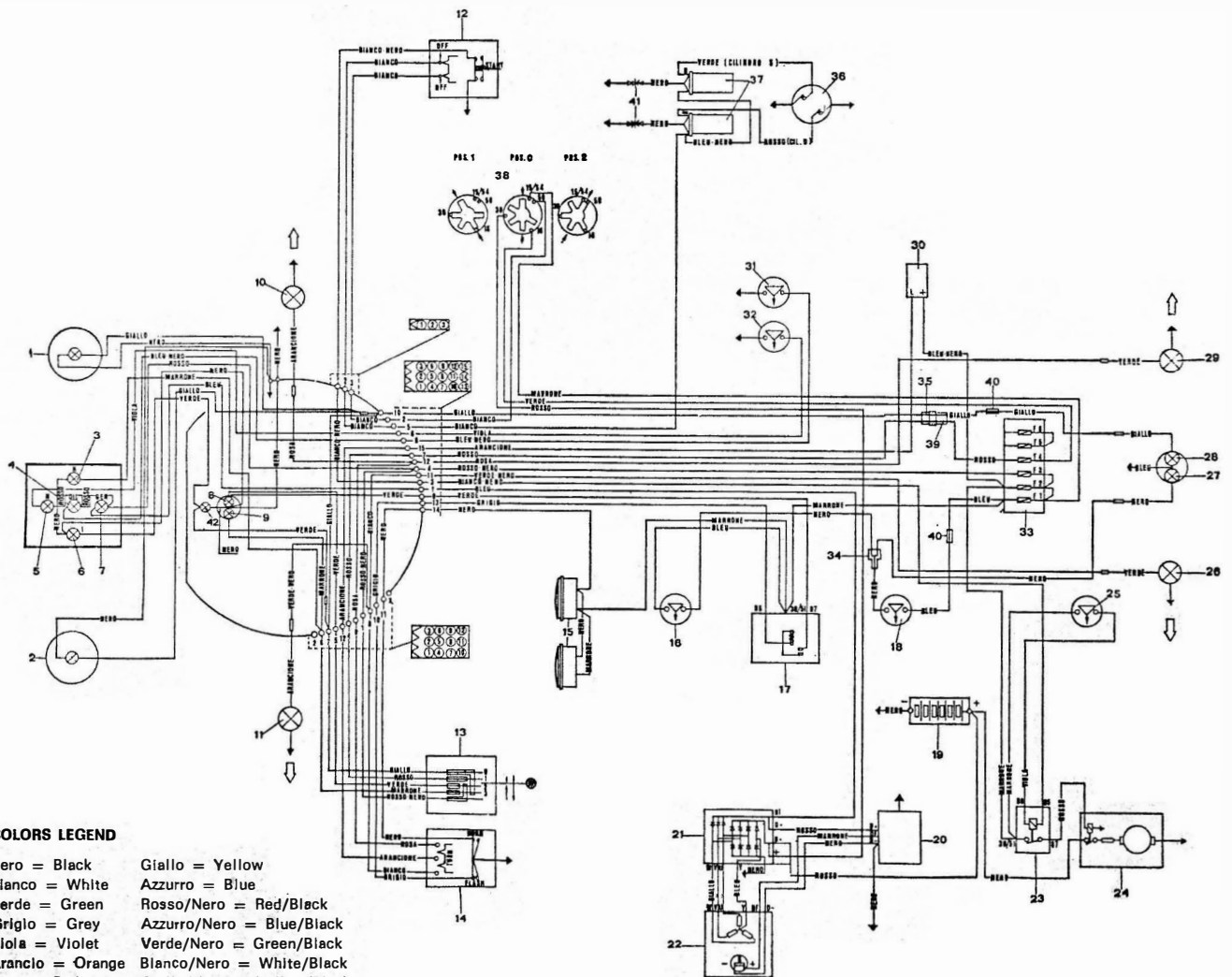

COLORS LEGEND

Nero = Black	Giallo = Yellow
Bianco = White	Azzurro = Blue
Verde = Green	Rosso/Nero = Red/Black
Grigio = Grey	Azzurro/Nero = Blue/Black
Viola = Violet	Verde/Nero = Green/Black
Arancio = Orange	Bianco/Nero = White/Black
Rosa = Pink	Giallo/Nero = Yellow/Black
Rosso = Red	Grigio/Nero = Grey/Black
Marrone = Brown	Grigio/Rosso = Grey/Red

LIGHTS (U.S.A. model)

HEADLIGHT

- Sealed beam insert type: 45/40 W - 12 V.

TAIL LIGHT

- Number plate lighting parking light and stop light: bulb 5/21 W - 12 V.

Turn signals: 21 W - 12 V.

Indicators, instrument panel: bulb 1,2 W - 12 V.
Indicators, mile and rev. counters: bulb 3 W - 12 V.

REPLACEMENT OF BULBS (fig. 212/1)

TAIL LIGHT

- Undo screws « C » securing reflector to tail light; push bulb inwards and turn it to the left at the same time, then slip it off.

TURN SIGNALS

- Undo screws « D » securing reflectors to signal lights; push bulbs and turn them to the left at the same time, then slip them off.

By re-fitting of reflectors screw in uniformly, do not lock screws too much to prevent braking of same.

INSTRUMENTS PANEL, MILE AND REV. COUNTERS

- Slip off bulb sockets and replace bulbs.

HEADLIGHT BEAM ADJUSTING (fig. 212/1)

For a safe riding and not to trouble crossing riders, the headlight beam has always to be set at a correct height.

For horizontal setting undo screw « A ».

For vertical setting undo connections « E » and shift the headlight by hand up or down in order to get the correct height.

The centre of the high beam must not be higher than 0,86 m measured at 3 m distance with motorcycle not on stand and rider on saddle.

CHANGING THE WIRING DIAGRAM FOR VEHICLES WITH COMPULSORY LIGHTING ON, WHEN STARTING THE ENGINE

To achieve this change it is necessary to take off the wire group which connects connector « 35 » to fuse n. 4 (red cable) and to connection « 40 » (yellow cable). This wire group is connected to connector « 35 » through connector « 39 ».

After disconnecting the yellow cable (rear parking light) from connector « 40 », connect it to fuse n. 4 as indicated in the wiring diagram.

Connector « 35 » will be re-fitted, into the insulated housing which supports the flasher unit for turn signals.

This change accomplished, notice that instrument lights and indicator light « I » (Low beam) are not protected by fuse n. 4 but by fuse n. 3.

WIRING DIAGRAM (U.S.A. model)

(fig. 213/1)

- 1 - Mile counter (bulb 3 W)
- 2 - Rev. counter (bulb 3 W)
- 3 - High beam indicator light (1,2 W)
- 4 - Oil pressure indicator light (1,2 W)
- 5 - Neutral indicator (light 1,2 W)
- 6 - Low beam indicator light (1,2 W)
- 7 - Generator charge indicator light (1,2 W)
- 8 - Low beam (40 W)
- 9 - High beam (45 W)
- 10 - Right front turn signal light (21 W)
- 11 - Left front turn signal light (21 W)
- 12 - Engine starting and stopping switch
- 13 - Lighting switch
- 14 - Switch; turn signal, horns, flashing light
- 15 - Horns Power 7 A)
- 16 - Front brake stop light cutout
- 17 - Flashing light relay
- 18 - Rear brake stop light cutout
- 19 - Battery
- 20 - Regulator
- 21 - Rectifier
- 22 - Alternator
- 23 - Starter motor relay
- 24 - Starter motor
- 25 - Clutch cable cutout
- 26 - Left rear turn signal (21 W)
- 27 - Rear brake stop light (21 W)
- 28 - Number plate and parking light (5 W)
- 29 - Right rear turn signal (21 W)
- 30 - Flasher unit
- 31 - Oil pressure cutout
- 32 - Neutral position cutout
- 33 - Terminal block with fuses (16 A)
- 34 - 3-way connector
- 35 - 4-way connector
- 36 - Contact breaker
- 37 - Coils
- 38 - Ignition switch (3 positions)
- 39 - 4-way connector
- 40 - 2-way connector
- 41 - Spark plugs
- 42 - Light switch, with stop device from position « High-Low Beam » to position « Parking light »

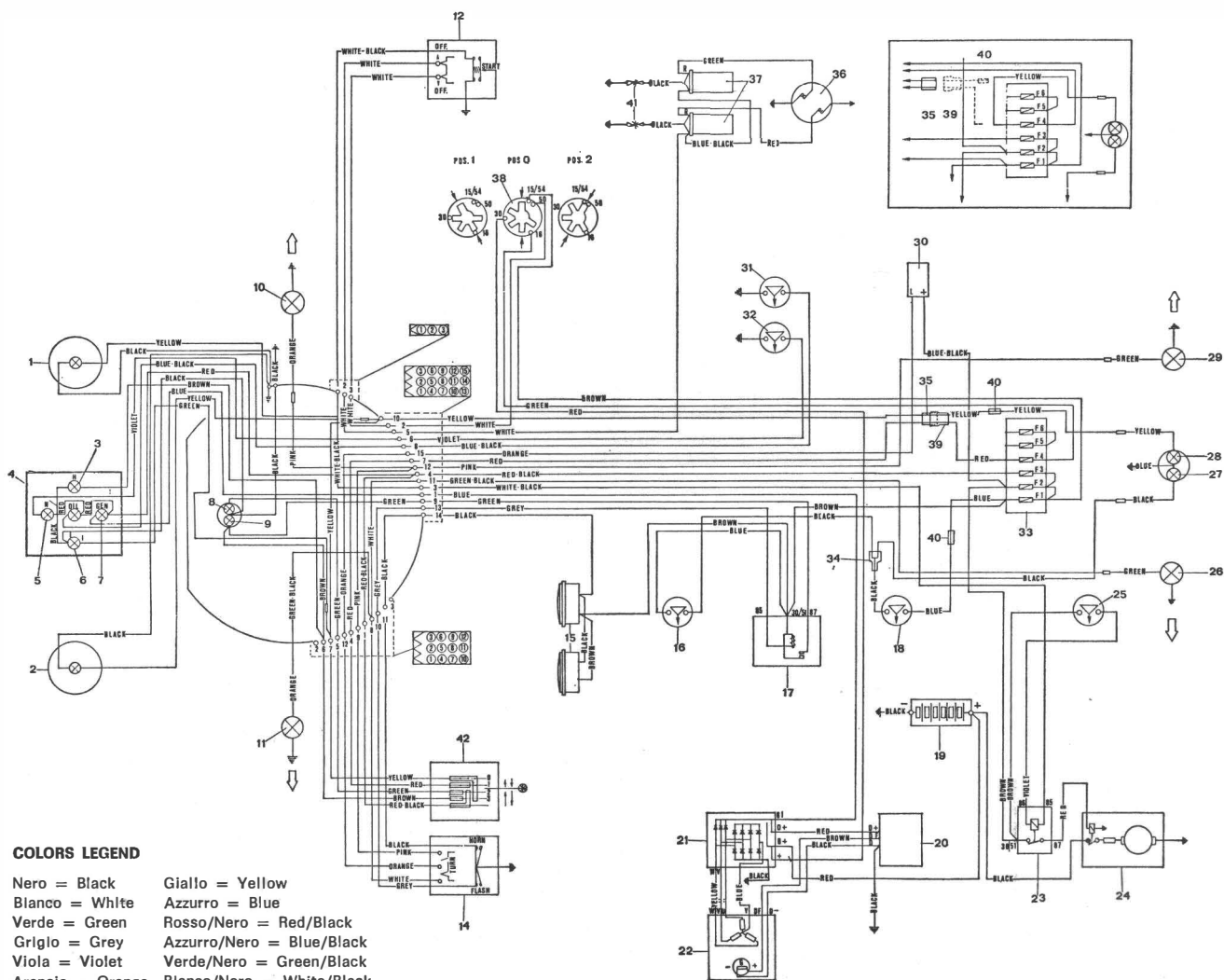

COLORS LEGEND

- | | |
|------------------|----------------------------|
| Nero = Black | Giallo = Yellow |
| Bianco = White | Azzurro = Blue |
| Verde = Green | Rosso/Nero = Red/Black |
| Grigio = Grey | Azzurro/Nero = Blue/Black |
| Viola = Violet | Verde/Nero = Green/Black |
| Arancio = Orange | Bianco/Nero = White/Black |
| Rosa = Pink | Giallo/Nero = Yellow/Black |
| Rosso = Red | Grigio/Nero = Grey/Black |
| Marrone = Brown | Grigio/Rosso = Grey/Red |

**ADDITIONS AND CHANGES
FOR 850-T3 - "LAPD,, POLICE MODEL (USA)**

INSTRUMENTS AND CONTROLS

INSTRUMENT PANEL (fig. 214/1)

- 1 Mile counter, speedometer.
- 2 Left turn indicator warning light (green).
- 3 Right turn indicator warning light (green).
- 4 « H » high beam warning light (red).
- 5 « N » neutral position warning light (orange).
- 6 « Gen » warning light indicating insufficient battery charge from generator (red).
- 7 « Oil » warning light indicating insufficient oil pressure (red).
- 8 « Park » warning light (green) indicating side stand in parking position.
- 9 « L » warning light, parking (red).
- 10 « Purs » warning light (red) indicating red lights on.
- 11 « Rad » warning light (violet) indicating radio on.
- 12 « Light » switch for additional lights.
- 13 « Emerg » switch controlling simultaneous flashing of rear turn indicator lights (the switch controls also the flashing of warning lights « 2 » and « 3 »).
- 14 Odometer reset.

CONTROL BUTTONS FOR RADIO, SIRENE AND RED LIGHTS (fig. 215/1)

This group is mounted on the right handlebar:

- « 1 » Radio control button (white).

- « 2 » Sirene control button (blue).
« 3 » Red lights control (red).
« 4 » Sirene control (blue).

TERMINAL BLOCK WITH FUSES (fig. 211)

The terminal block is located on the right side of the motorcycle.

Access to the terminal block is made possible by removal of the right motorcycle side cover and terminal block cover.

It incorporates n. 6 16 A fuses.

Key controlled

- « 1 » Rear stop light, horns, flashing lights.
« 2 » Starter motor relay.
« 3 » Warning lights: « Oil - Gen - N » - Headlight: high beam, low beam and warning lights.
« 4 » Rear parking lights, instrument lighting, warning light « L » rear blue lights.

Out of key control

- « 5 » Red lights and warning light « Purs »; additional light.
« 6 » Turn indicator lights with their warning lights.

WIRING DIAGRAM

(fig. 216/1)

- 1 - Mile counter, speedometer (bulb 3 W)
- 2 - Additional light (bulb 5 W)
- 3 - « H » high beam warning light (bulb 1,2 W)
- 4 - « Oil » Oil pressure warning light (bulb 1,2 W)
- 5 - « N » Neutral position warning light (bulb 1,2 W)
- 6 - « L » Low beam (bulb 1,2 W)
- 7 - « Gen » Generator warning light
- 8 - Low beam } bulb 40/45 W
- 9 - High beam }
- 10 - Turn indicator light, front/right (bulb 21 W)
- 11 - Turn indicator light, left/front (bulb 21 W)
- 12 - Engine starting and stopping control
- 13 - Additional light switch
- 14 - Control switch: turn indicator lights, horns, flashing
- 15 - Horn (Consumption 7 A)
- 16 - Front brake switch
- 17 - Flashing light relay
- 18 - Rear brake switch
- 19 - Battery
- 20 - Regulator
- 21 - Rectifier
- 22 - Alternator
- 23 - Starter motor relay
- 24 - Starter motor
- 25 - Switch on clutch control wire
- 26 - Turn indicator light - rear/left (bulb 21 W)
- 27 - Rear stop light (bulb 21 W)
- 28 - Number plate and tail light (bulb 5 W)
- 29 - Turn indicator light - rear/right (bulb 21 W)
- 30 - Turn indicator lights flasher unit
- 31 - Oil pressure switch
- 32 - Neutral switch
- 33 - Terminal block with fuses (16 A fuses)
- 34 - 3-way connector
- 35 - 4-way connector (Amp)
- 36 - Breaker
- 37 - Coils
- 38 - Ignition switch (3 positions)
- 39 - Control actuating simultaneous flashing of turn indicator lights
- 40 - 2-way connector
- 41 - Spark plugs
- 42 - Light switch with travel limit from position « High/Low beam » to position « Parking light »
- 43 - Right turn indicator warning light (bulb 1,2 W)
- 44 - Left turn indicator warning light (bulb 1,2 W)
- 45 - « Park » Side stand parking position warning light (bulb 1,2 W)
- 46 - « Purs » Red pursuing lights warning lights (bulb 1,2 W)
- 47 - « Rad » Radio warning light (bulb 1,2 W)
- 48 - 4-way connector (Amp)
- 49 - Connection
- 50 - Red pursuing lights (front) - (bulb 35 W)
- 51 - Control: red lights - radio - syrene
- 52 - Syrene relay
- 53 - Coil control device
- 54 - Control device for side stand warning light
- 55 - Syrenes (90 W)
- 56 - Rear blue lights (bulb 5 W)
- 57 - Spare fuse

The devices no. 53 and no. 54 and cables « A - B - C - D » are supplied only on request: when the above parts are not installed, the white cable coming from clamp no. 5 (15-way Molex - Headlight) must be connected directly on to the coil (connection no. 40 to be eliminated).

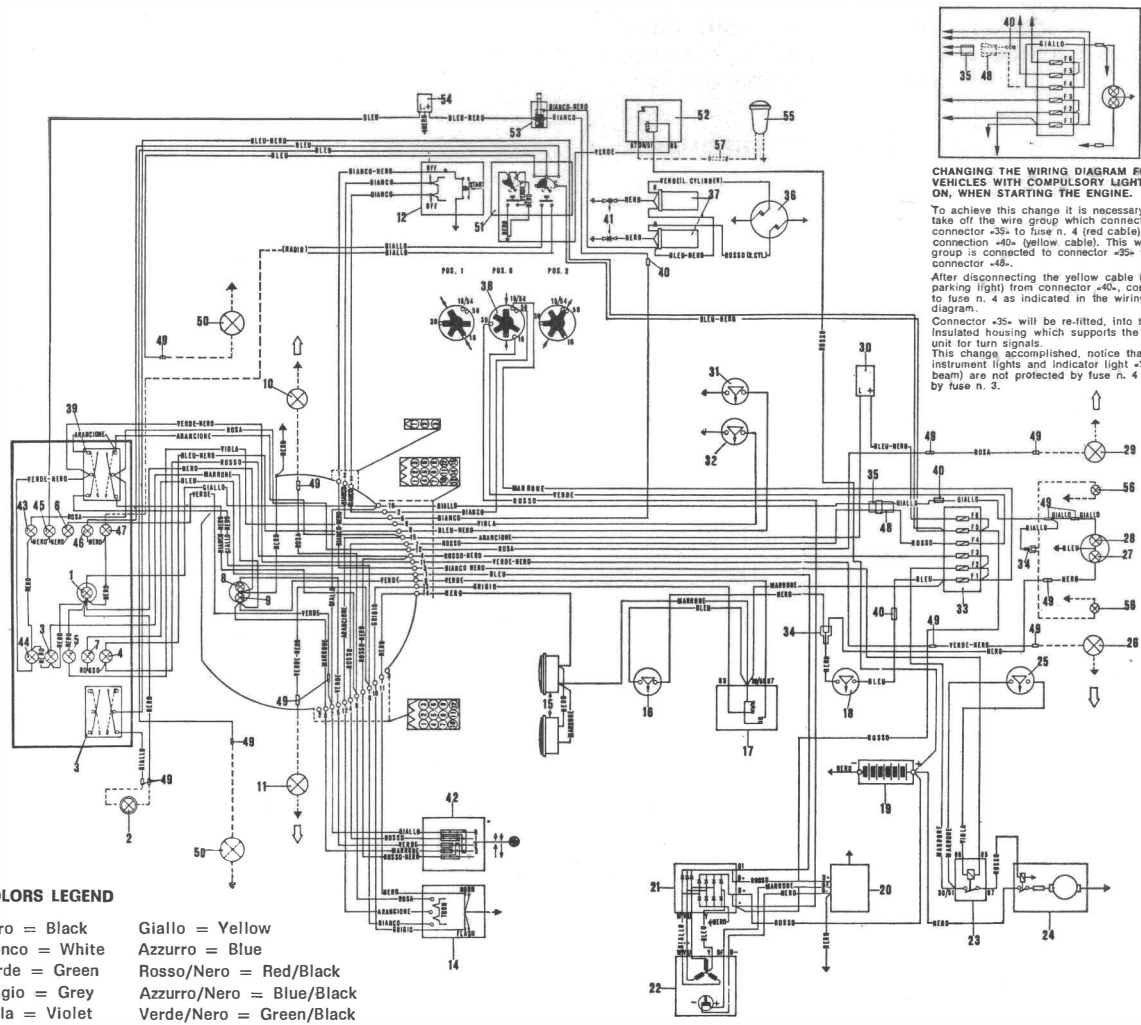

COLORS LEGEND

- | | |
|------------------|----------------------------|
| Nero = Black | Giallo = Yellow |
| Bianco = White | Azzurro = Blue |
| Verde = Green | Rosso/Nero = Red/Black |
| Grigio = Grey | Azzurro/Nero = Blue/Black |
| Viola = Violet | Verde/Nero = Green/Black |
| Arancio = Orange | Bianco/Nero = White/Black |
| Rosa = Pink | Giallo/Nero = Yellow/Black |
| Rosso = Red | Grigio/Nero = Grey/Black |
| Marrone = Brown | Grigio/Rosso = Grey/Red |

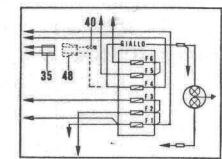

CHANGING THE WIRING DIAGRAM FOR VEHICLES WITH COMPULSORY LIGHTING ON, WHEN STARTING THE ENGINE.

To achieve this change it is necessary to take off the wire group which connects connector «35» to fuse n. 4 (red cable) and to connection «40» (yellow cable). This wire group is connected to connector «35» through connector «48».

After disconnecting the yellow cable (rear parking light) from connector «40», connect it to fuse n. 4 as indicated in the wiring diagram.

Connector «35» will be re-fitted, into the insulated housing which supports the flasher unit for turn signals.

This change accomplished, notice that instrument lights and indicator light «1» (Low beam) are not protected by fuse n. 4 but by fuse n. 3.

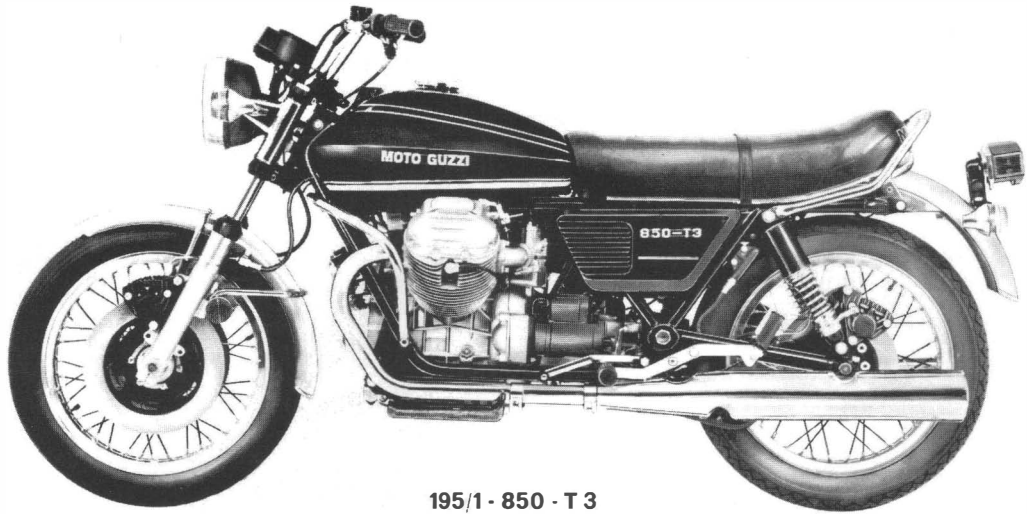

195/1 - 850 - T 3

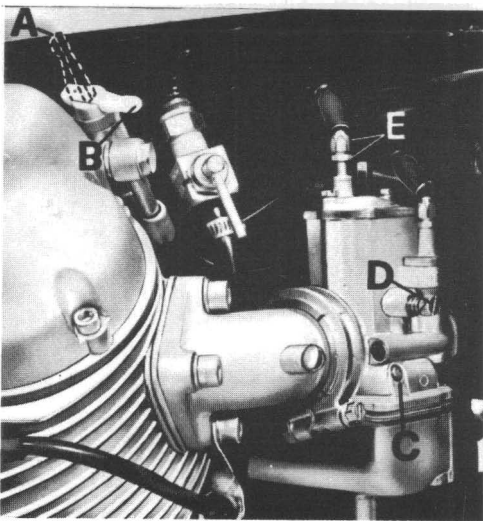

196

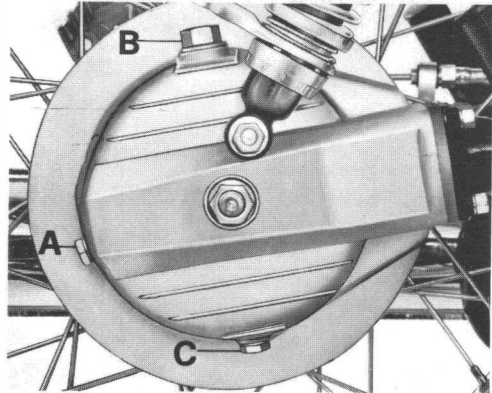

199

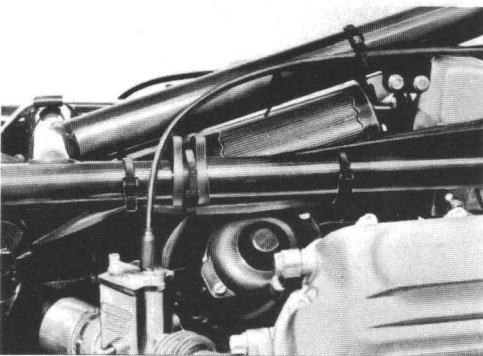

197

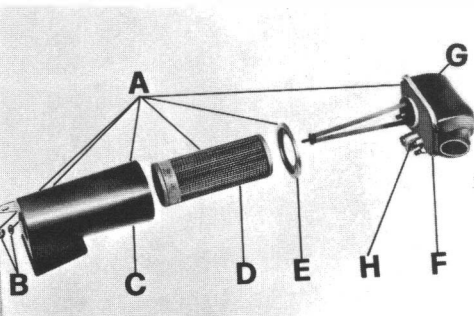
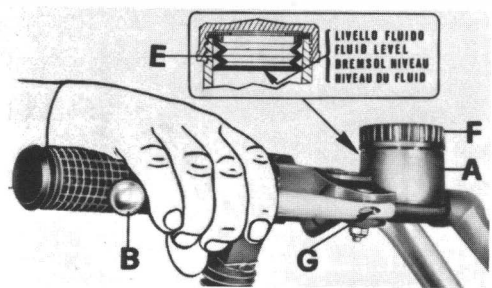

198

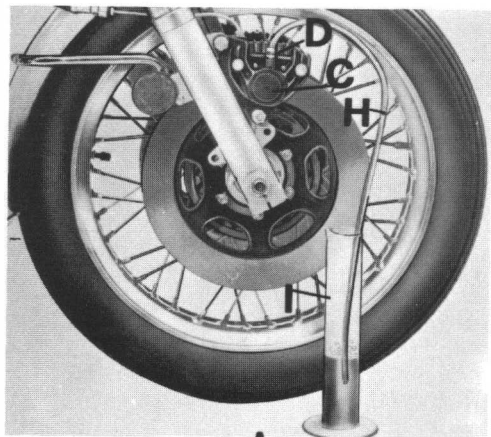

200

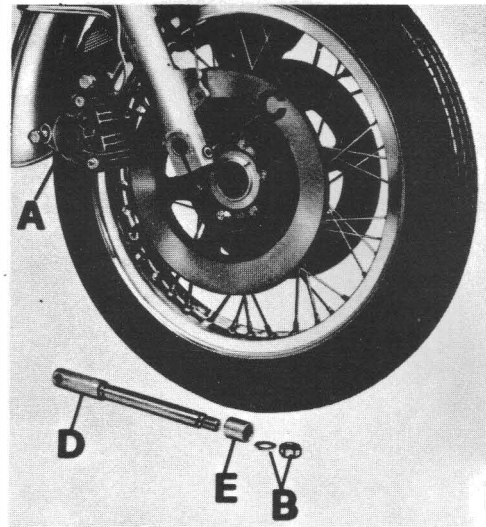
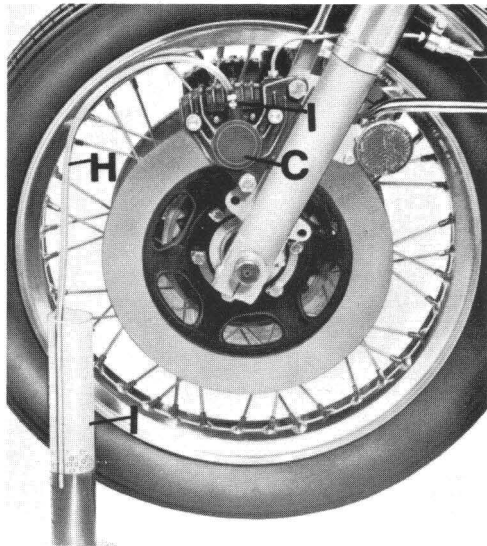

203

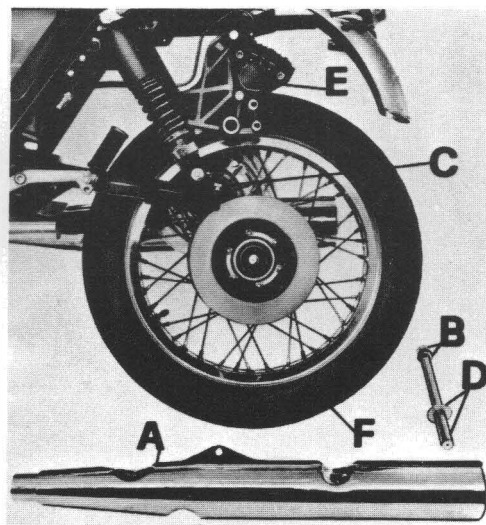
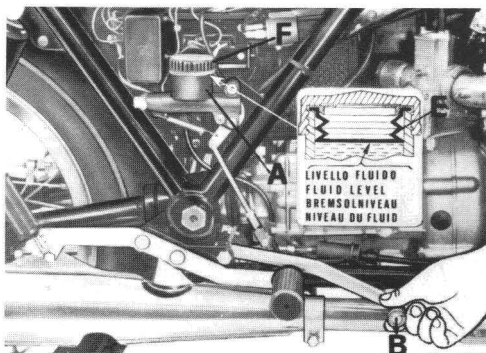

204

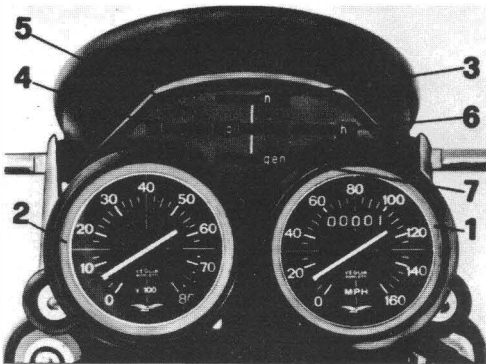
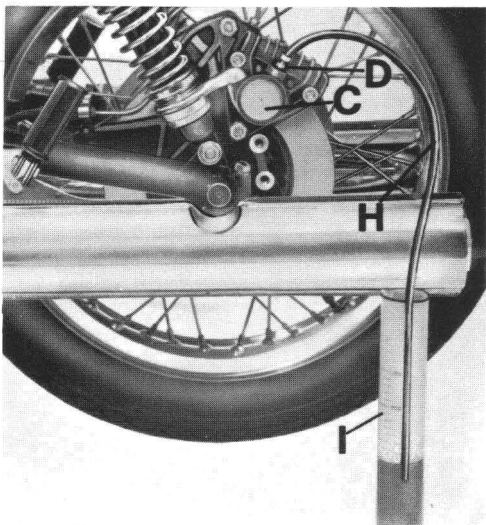

205

201

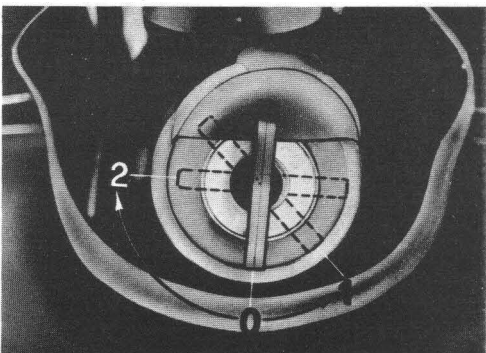
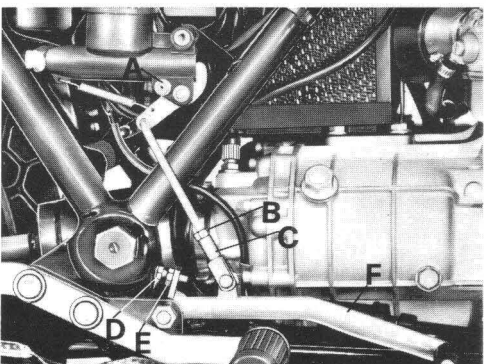

206

202

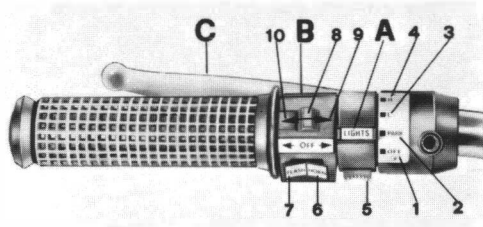

207

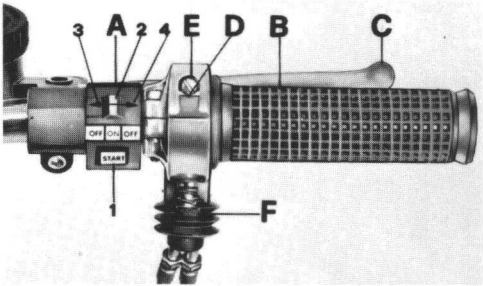
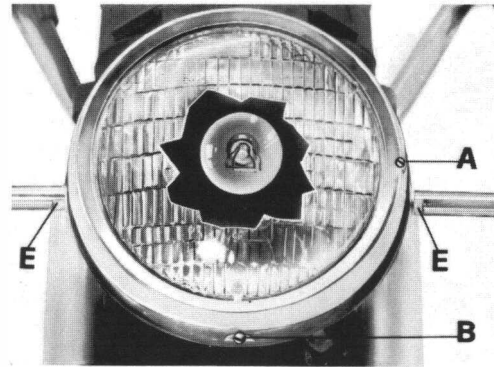

208

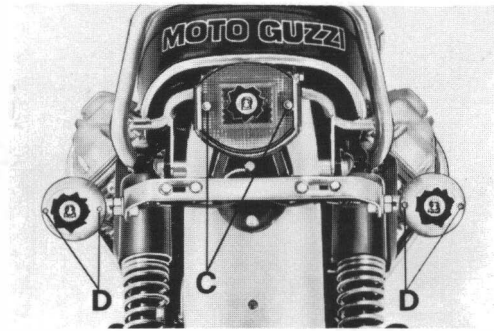

212

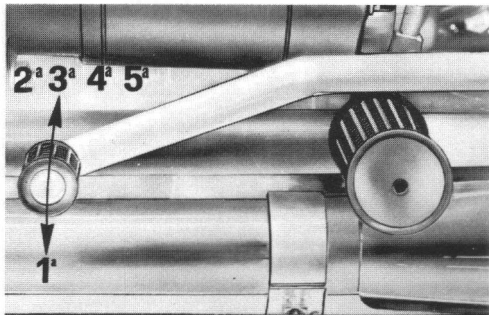

209

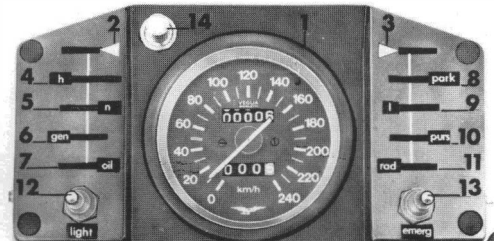

214

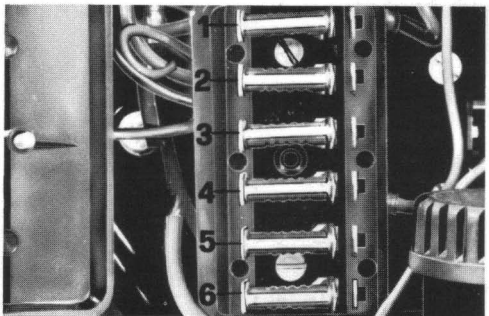

210

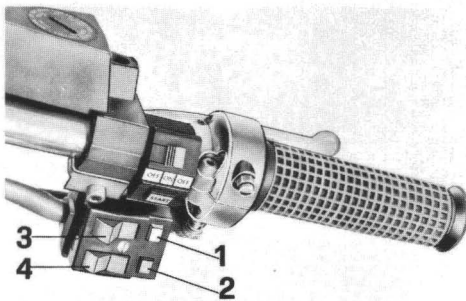

215

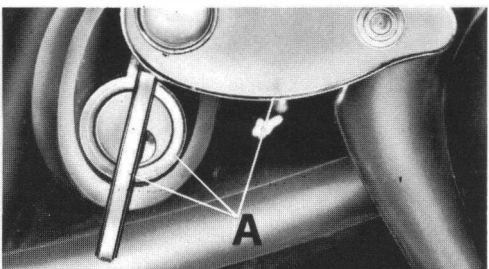

211