



MOTO GUZZI®

PROUDLY AUTHENTIC MOTORCYCLES. SINCE 1921.

SERVICE STATION MANUAL

2Q000400



V85 TT



SERVICE STATION MANUAL

V85 TT

THE VALUE OF SERVICE

As a result of continuous updates and specific technical training programmes for Moto Guzzi products, only **Moto Guzzi** Official Network mechanics know this vehicle fully and have the specific tools necessary to carry out maintenance and repair operations correctly.

The reliability of the vehicle also depends on its mechanical conditions. Checking the vehicle before riding it, its regular maintenance and the use of **original Moto Guzzi spare parts** only are essential factors!

For information on the nearest **Official Dealer and/or Service Centre** consult our website:

www.motoguzzi.com

Only by requesting Moto Guzzi original spare parts can you be sure of purchasing products that were developed and tested during the actual vehicle design stage. All Moto Guzzi original spare parts undergo quality control procedures to guarantee reliability and durability.

The descriptions and images in this publication are given for illustrative purposes only and are not binding. While the basic characteristics as described and illustrated in this booklet remain unchanged, Piaggio & C. S.p.A. reserves the right, at any time and without being required to update this publication beforehand, to make any changes to components, parts or accessories, which it considers necessary to improve the product or which are required for manufacturing or construction reasons.

Not all versions/models shown in this publication are available in all countries. The availability of individual versions should be checked with the Official Moto Guzzi sales network.

The Moto Guzzi brand is owned by Piaggio & C. S.p.A.

© Copyright 2019 - Piaggio & C. S.p.A. All rights reserved. Reproduction of this publication in whole or in part is prohibited.

Piaggio & C. S.p.A. Viale Rinaldo Piaggio, 25 - 56025 PONTEDERA (PI), Italy

www.piaggio.com

SERVICE STATION MANUAL

V85 TT

This manual provides the main information to carry out regular maintenance operations on your vehicle. This manual is intended to **Moto Guzzi Dealers** and their qualified mechanics; several concepts have been deliberately omitted as they are considered unnecessary. As it is not possible to include complete mechanical notions in this manual, users should have basic mechanical knowledge or minimum knowledge about the procedures involved when repairing scooters. Without this knowledge, repairing or checking the vehicle may be inefficient or even dangerous. As the vehicle repair and check procedures are not described in detail, be extremely cautious so as not to damage components or injure individuals. In order to optimise customer satisfaction when using our vehicles, **Piaggio & C. s.p.a.** commits itself to continually improve its products and the relative documentation. The main technical modifications and changes in repair procedures are communicated to all **Moto Guzzi Sales Outlets and its International Subsidiaries**. These changes will be introduced in the subsequent editions of the manual. In case of need or further queries on repair and check procedures, consult **Moto Guzzi CUSTOMER DEPARTMENT**, which will be prepared to provide any information on the subject and any further communications on updates and technical changes related to the vehicle.

NOTE Provides key information to make the procedure easier to understand and carry out.

CAUTION Refers to specific procedures to carry out for preventing damages to the vehicle.

WARNING Refers to specific procedures to carry out to prevent injuries to the repairer.



Personal safety Failure to completely observe these instructions will result in serious risk of personal injury.



Safeguarding the environment Sections marked with this symbol indicate the correct use of the vehicle to prevent damaging the environment.



Vehicle intactness The incomplete or non-observance of these regulations leads to the risk of serious damage to the vehicle and sometimes even the invalidity of the guarantee



INDEX OF TOPICS

CHARACTERISTICS

CHAR

SPECIAL TOOLS

S-TOOLS

MAINTEENANCE

MAIN

ELECTRICAL SYSTEM

ELE SYS

ENGINE FROM VEHICLE

ENG VE

ENGINE

ENG

POWER SUPPLY

P SUPP

SUSPENSIONS

SUSP

CHASSIS

CHAS

BRAKING SYSTEM

BRAK SYS

BODYWORK

BODYW

PRE-DELIVERY

PRE DE

INDEX OF TOPICS

CHARACTERISTICS

CHAR

Vehicle identification

SERIAL NUMBER LOCATION

These numbers are necessary for vehicle registration.

NOTE

ALTERING IDENTIFICATION NUMBERS MAY BE SERIOUSLY PUNISHABLE BY LAW. IN PARTICULAR, MODIFYING THE CHASSIS NUMBER IMMEDIATELY VOIDS THE WARRANTY.

FRAME NUMBER

The chassis number is stamped on the RH side of the headstock.

This number consists of numbers and letters, as in the example shown below.

ZGUKWA000MXXXXXX

Key:

ZGU: WMI (World Manufacturer Identifier) code;

KW: model;

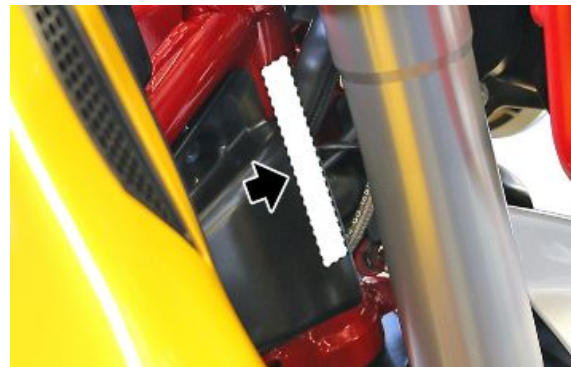
A00: version variant;

0: free digit

G: variable year of manufacturer (G - for 2019)

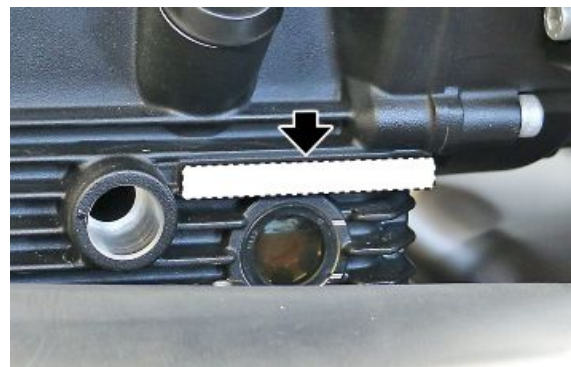
M: production plant (M= Mandello del Lario);

XXXXXX: serial number (6 digits);



ENGINE NUMBER

The engine number is stamped on the left side, close to the engine oil level check cap.



Dimensions and mass

WEIGHT AND DIMENSIONS

Specification	Desc./Quantity
Max. length	2,240 mm (88.19 in)
Maximum width	950 mm (37.40 in)
Height (at adjustable windshield)	1300 - 1325 mm (51.18 - 52.17 in)
Wheelbase	1530 mm (60.24 in)
Kerb weight	229 kg (504.86 in)

Engine

ENGINE

Specification	Desc./Quantity
Type	traverse-mounted twin-cylinder four-stroke V 90°
Cylinder number	2
Engine capacity	853 cm ³ (52.05 cu.in)
Bore / stroke	84x77 mm (3.31x3.03 in)
Compression ratio	10.5 ± 0.5 : 1
Start-up	Electric
Engine idle speed	1250 +/- 100 rpm
Clutch	dry single-disc clutch with flexible coupling
Lubrication	pressure-fed, controlled by valves and trochoidal pump
Air filter	cartridge-type dry filter
Cooling	air

Transmission

TRANSMISSION

Specification	Desc./Quantity
Primary drive	with gears, ratio 18/23 = 1 : 1.277
Gear ratios, 1st gear	16 / 39 = 1 : 2.437
Gear ratios, 2nd gear	18 / 32 = 1 : 1.777
Gear ratios, 3rd gear	21 / 28 = 1 : 1.333
Gear ratios, 4th gear	24 / 26 = 1 : 1.083
Gear ratios, 5th gear	25 / 24 = 1 : 0.96
Gear ratios, 6th gear	27 / 24 = 1 : 0.888
Final drive	with cardan shaft, ratio: 8 / 33 = 1 : 4.125

GEARBOX

Specification	Desc./Quantity
Type	mechanical, 6 speeds with foot lever on the left hand side of the engine

Capacities

CAPACITY

Specification	Desc./Quantity
Fuel tank (reserve included)	23 +/- 1 l (5.06 +/- 0.22 UK gal; 6.08 +/- 0.26 US gal)
Fuel tank reserve	5 +/- 0.5 l (1.10 +/- 0.11 UK gal; 1.32 +/- 0.13 US gal)
Engine oil	Oil change and oil filter replacement: 1760 cm ³ (107.40 cu.in)
Gearbox oil	700 cm ³ (42.72 cu.in)
Bevel gear set oil	180 cm ³ (10.98 cu.in)
Seats	2
Maximum carrying load	448 kg (987.67 lb) (rider + passenger + luggage)

Electrical system

ELECTRICAL SYSTEM

Specification	Desc./Quantity
Battery	12 V - 12 Ah
Fuses	30 - 20 - 15 (3) - 7.5 (4) A
Permanent magnet alternator	12V - 430W

BULBS

Specification	Desc./Quantity
High beam/low beam light	LED
Front daylight running lights	LED
Turn signal lights	LED
Rear daylight running light /stop light	LED
Dashboard lighting	LED

INDICATOR LAMPS

Specification	Desc./Quantity
Gearbox in neutral	LED
High beam light	LED
Cruise control indicator light	LED
ABS indicator light	LED
MI indicator light	LED
Turn indicators	LED
Overspeed threshold/shift light indicator lights	LED
Immobilizer indicator light	LED
Fuel reserve	LED
MGCT indicator light	LED
General alarm	LED
Daytime light indicator light	LED
Side stand indicator light	LED

SPARK PLUGS

Specification	Desc./Quantity
Standard	NGK IR MR8BI-8
Spark plug electrode gap	0.8 mm (0.031 in)
Resistance	7.5 KOhm (MAX)

Frame and suspensions**FRAME**

Specification	Desc./Quantity
Type	High strength steel tube
Steering rake	25.7°
Trail	128.3 mm (5.05 in)

SUSPENSIONS

Specification	Desc./Quantity
Front	hydraulic telescopic fork diam. 41 mm (1.61 in)
Stroke	168 mm (6.61 in)
Rear	Swingarm in die-cast light alloy with 1 shock absorber with adjustable spring pre-load and rebound damping.
Stroke	102 mm (4.02 in)

Brakes**BRAKES**

Specification	Desc./Quantity
Front	stainless steel floating disc diam. 320 mm (12.59 in) calliper with 4 horizontally opposed pistons diam. 32 mm (1.26 in)
Rear	stainless steel disc diam. 260 mm (10.24 in) floating calliper with 2 pistons diam. 22 mm (0.87 in)

Wheels and tyres

TYRES

Specification	Desc./Quantity
Front	110 / 80 R19 59V
Inflation pressure	2.5 bar (250 kPa) (36.26 PSI)
Rear	150 / 70 R17 69V
Inflation pressure	2.8 bar (280 Kpa) (40.61 PSI)
WARNING	If knobbly tyres are used, we recommend reducing the inflation pressure by 0.2 bar (20 Kpa) (2.90 PSI) at the front and 0.3 bar (30 Kpa) (4.35 PSI) at the rear.

WHEELS

Specification	Desc./Quantity
Type	alloy, with spokes
Front	2.5" x 19"
Rear	4.25" x 17"

Supply

FUEL SYSTEM

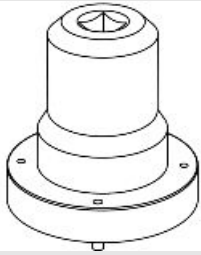
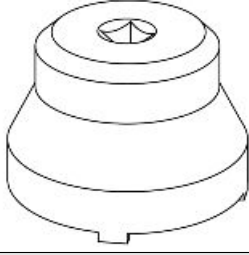
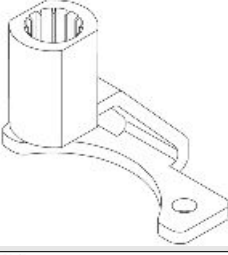
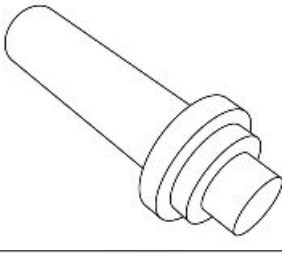
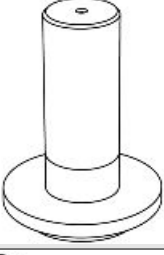
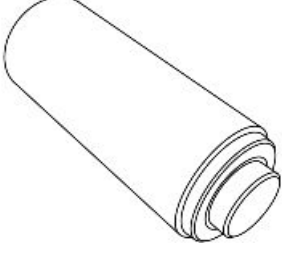
Specification	Desc./Quantity
Type	Electronic injection (Marelli 7SM2)
Venturi	diam. 52 mm (2.05 in)
Fuel	Unleaded petrol max E10 (95 RON).



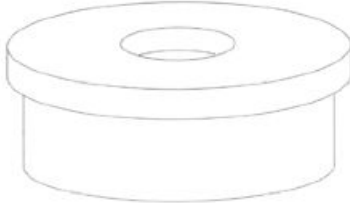
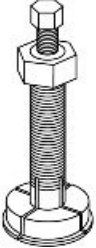
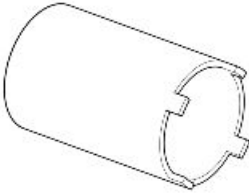
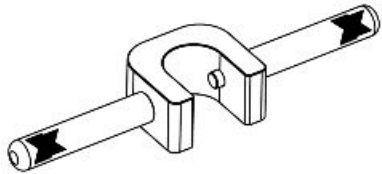
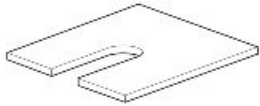
INDEX OF TOPICS

SSPECIAL TOOLS

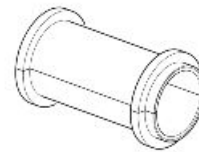
S-TOOLS

SPECIAL TOOLS

Stores code	Description	
020998Y	Pinion case wrench	
020999Y	Crown counter- lock ring wrench	
021000Y	Bevel gear pair support	
021003Y	Bevel gear oil seal punch	
021005Y	Punch seals on the bevel gear cover	
020978Y	Cardan secondary oil seal mounting punch	

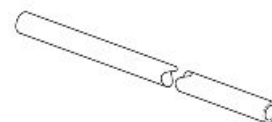
Stores code	Description	
GU19927900	Punch for pressing bearing inner ring on-to drilled pin	
020376Y	Sleeve for adaptors	
020360Y	52 x 55-mm Adaptor	
001467Y036	Bearing internal cup extractor	
020966Y	Steering adjustment socket	
020888Y	Preload tube clamp	
AP8140148	Plunger-spacer separator plate	

Stores code	Description
AP8140189	Tool for fitting oil seal for 43 mm (1.69 in) diameter hole



AP8140146	Weight	A technical line drawing of a small, hollow cylindrical component.
-----------	--------	--

AP8140150	Bored shaft for bleeding plunger air
-----------	--------------------------------------



AP8140149	Guard for assembly operations	A technical line drawing of a square guard with a circular opening on one side.
-----------	-------------------------------	---

020922Y	Diagnostic tool
---------	-----------------



020931Y	PADS instrument panel connection cable
---------	--



INDEX OF TOPICS

MAINTENANCE

MAIN

Scheduled maintenance table

NOTE

CARRY OUT MAINTENANCE OPERATIONS AT HALF THE INTERVALS SPECIFIED IF THE VEHICLE IS USED IN PARTICULAR RAINY OR DUSTY CONDITIONS, OFF ROAD OR FOR TRACK USE.

NOTE

THE TIMES LISTED ON THE SCHEDULED MAINTENANCE TABLE INCLUDE TIME DEDICATED TO MANAGEMENT ACTIVITIES.

I: INSPECT AND CLEAN, ADJUST, LUBRICATE OR REPLACE IF NECESSARY

C: CLEAN, R: REPLACE, A: ADJUST, L: LUBRICATE

(1): Replace if leaks occur

(2): Replace every 4 years

(3): At each engine start

(4): Check every month

(5): Check every 5,000 km (3,106 mi)

(6): Check and clean, adjust or replace, if necessary, every 1,000 km (621 mi)

(7): Replace when whichever of the following comes first: 40,000 km (24,855 mi) or 4 years

(8): At each service (except the first one), check if there is oil inside the filter box. If this is the case, clean it.

SCHEDULED MAINTENANCE TABLE

Km x 1.000 (mi x 1,000)	1,5	10	20	30	40	50	60	EVER	EVER
	(0.9)	(6.2)	(12.4)	(18.6)	(24.9)	(31.1)	(37.3)	Y 12	Y 24
								MONT	MONT
								HS	HS
Spark plugs		I	I	R	I	I	R		
Steering bearings and steering clearance	I	I	I	I	I	I	I	I	I
Wheel bearings - Wheels		I	I	I	I	I	I	I	I
Diagnosis by tool	I	I	I	I	I	I	I	I	I
Brake discs - Brake pad wear (4)	I	I	I	I	I	I	I	I	I
Air filter		R	R	R	R	R	R		
Engine oil filter	R	R	R	R	R	R	R	R	R
Vehicle general operation	I	I	I	I	I	I	I	I	I
Valve clearance	A	A	A	A	A	A	A		
Braking systems	I	I	I	I	I	I	I	I	I
Light circuit	I	I	I	I	I	I	I	I	I
Safety switches	I	I	I	I	I	I	I	I	I
Brake fluid	I	I	I	I	I	I	I	I	R
Gearbox oil				R			R		
Fork oil (5)					R				
Engine oil (3)	R	R	R	R	R	R	R	R	R
Final drive oil				R			R		
Headlight aiming		I	I	I	I	I	I		
Fork oil seals (1)		I	I	I	I	I	I		
Tyres - pressure / wear (2)	I	I	I	I	I	I	I	I	I
Clutch clearance adjustment	A	A	A	A	A	A	A	A	A
Bolts and nuts tightening	I	I	I	I	I	I	I		
Suspension and set-up			I		I		I	I	I
Filter box drain plug		C	C	C	C	C	C	C	C
Brake pipes		I	I	I	I	I	I		
Fuel lines		I	I	I	I	I	I	I	I
Labour time (minutes)

NOTE

AT EACH SCHEDULED MAINTENANCE MUST BE VERIFIED WITH THE DIAGNOSTIC TOOL IF THERE ARE ERRORS AND THE IF THE PARAMETERS ARE CORRECT.

ENSURE THAT THE VEHICLE CALIBRATION IS UP TO DATE AFTER UPDATING THE DIAGNOSTIC TOOL.

CAUTION

AFTER THE PROVIDED MAINTENANCE PROGRAM IS INDICATED TO PROCEED WITH THE MAINTENANCE OF THE VEHICLE STARTING FROM THE SERVICE OF 10,000 Km OR 10 MONTHS

Recommended products

Piaggio Group recommends the products of its "Castrol Official Partner" for the scheduled maintenance of its vehicles.

Use lubricants and liquids having specifications that are equivalent, or superior, to the recommended products. These indications also apply when topping up fluid levels.



TABLE OF RECOMMENDED PRODUCTS

Product	Description	Specifications
Engine oil 10W-60	Synthetic based lubricant for high performance four-stroke engines.	SAE 10W 60; JASO MA, MA2; API SG
75W-140 lubricant for gearboxes and transmissions	Synthetic lubricant for gearboxes and transmissions	SAE 75W-140 - API GL5
Fork oil 7.5W	Fork oil.	SAE 7.5W
Molybdenum disulphide grease	Lithium grease with molybdenum disulphide	Grey black grease.
Vaseline	neutral grease for battery terminals	-
Brake fluid DOT 4	Synthetic brake fluid.	SAE J 1703; FMVSS 116; ISO 4925; CUNA NC 956 DOT4

Spark plug

- Unscrew and remove the screws (1)



- Remove the cover (2).



- Disconnect the spark plug cap (3)



- Unscrew the spark plug (4) and remove it



Check

- Keep the vehicle upright with both wheels on the ground.
- Unscrew and remove the cap/dipstick (1).
- The level is correct if the oil is close to the cap/dipstick opening (1).
- If the oil is lower than specified, top-up until it reaches the cap/dipstick hole (1).



CAUTION



DO NOT ADD ADDITIVES OR OTHER SUBSTANCES TO THE FLUID. WHEN USING A FUNNEL OR ANY OTHER ELEMENT, MAKE SURE IT IS PERFECTLY CLEAN.

Replacement

CAUTION

THE UNIT MUST BE HOT WHEN THE OIL IS CHANGED AS UNDER SUCH CONDITIONS OIL IS FLUID AND THEREFORE EASY TO DRAIN.

NOTE

RIDE SOME km (miles) TO WARM UP ENGINE OIL

- Place a recipient with a capacity of at least 400 cc (25 cu.in) under the drain plug (2).
- Unscrew and remove the drainage plug (2).
- Unscrew and remove the breather cap (1).
- Drain the oil into the container; allow several minutes for oil to drain out completely.
- Check and if necessary, replace the sealing washer of drainage plug (2).
- Remove any metal scrap attached to the drainage plug (2) magnet.
- Screw and tighten the drainage plug (2).
- Pour new oil through the fill opening until it reaches the cap/dipstick hole (1).

CAUTION

DO NOT ADD ADDITIVES OR OTHER SUBSTANCES TO THE FLUID. WHEN USING A FUNNEL OR ANY OTHER ELEMENT, MAKE SURE IT IS PERFECTLY CLEAN.

NOTE

THE RECOMMENDED QUANTITY OF OIL FOR REPLACEMENT IS 180 cc (10.98 cu in)

Recommended products

75W-140 lubricant for gearboxes and transmissions Synthetic lubricant for gearboxes and transmissions

SAE 75W-140 - API GL5

- Screw and tighten the caps (1 - 2).



Check

Check the engine oil level frequently.

NOTE

CARRY OUT MAINTENANCE OPERATIONS AT HALF THE INTERVALS SPECIFIED IF THE VEHICLE IS USED IN PARTICULAR RAINY OR DUSTY CONDITIONS, OFF ROAD OR FOR TRACK USE.



THE OIL LEVEL MUST BE CHECKED WHEN THE ENGINE IS WARM.

CAUTION

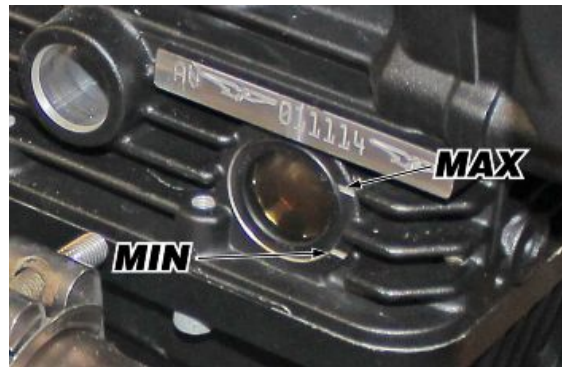
DO NOT LET THE ENGINE IDLE WITH THE VEHICLE AT A STANDSTILL TO WARM UP THE ENGINE AND OBTAIN THE OPERATING TEMPERATURE OF ENGINE OIL. PREFERABLY CHECK THE OIL AFTER A JOURNEY OF AFTER TRAVELLING APPROXIMATELY 15 Km (10 miles) IN EXTRA-URBAN CONDITIONS (ENOUGH TO WARM UP THE ENGINE OIL TO OPERATING TEMPERATURE).

- Shut off the engine.
- Keep the vehicle upright with both wheels on the earth.
- Using the relative opening on the engine casing, check the oil level.

MAX (top notch) = maximum level.

MIN (bottom notch) = minimum level

- The level is correct if it reaches the "MAX" level.



Replacement

NOTE

HOT OIL IS MORE FLUID AND WILL DRAIN OUT MORE EASILY AND COMPLETELY.

- Remove the sump guard
- Place a collection container of suitable capacity under the drain plug (1).
- Unscrew and remove the drain plug (1).



- Unscrew and remove the filler plug (2)
- Drain the oil into the container; allow several minutes for oil to drain out completely.
- Check and if necessary, replace the sealing washer of drainage plug (1).
- Remove any metal deposits attached to the drainage plug (1) magnet.
- Screw and tighten the drainage plug (1).



DO NOT DISPOSE OF OIL INTO THE ENVIRONMENT. DISPOSE OF ENGINE OIL IN A SEALED CONTAINER AND TAKE IT TO YOUR SUPPLIER OR TO THE NEAREST USED OIL COLLECTION CENTRE.

Engine oil filter

- Undo the two screws (1) and remove the cover (2).
- Remove the engine oil filter (3).
- Spread a thin layer of oil on the sealing ring of the new engine oil filter
- Fit the new engine oil filter with the spring facing downwards
- Refit the cover (2), screw and tighten the screw (1).



NOTE

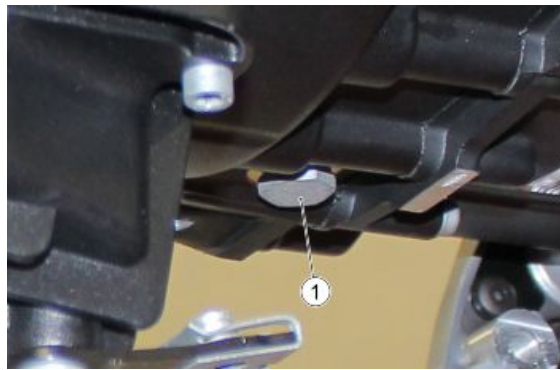
NEVER REUSE AN OLD FILTER.

Replacement

NOTE

HOT OIL IS MORE FLUID AND WILL DRAIN OUT MORE EASILY AND COMPLETELY.

- Remove the sump guard
- Remove the manifold-terminal
- Place a container of suitable capacity under the drain plug (1).
- Unscrew and remove the drain plug (1).



- Unscrew and remove the filler plug (2).
- Drain the oil into the container; allow several minutes for oil to drain out completely.
- Check and if necessary, replace the sealing washers of drainage plug (1).
- Remove any metal deposits attached to the drainage plug (1) magnet.
- Pour in new oil, observing the quantity indicated in the "Capacity" table

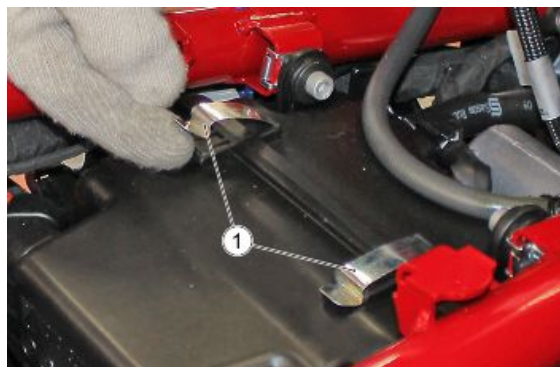
**CAUTION**

DO NOT ADD ADDITIVES OR OTHER SUBSTANCES TO THE FLUID. WHEN USING A FUNNEL OR ANY OTHER ELEMENT, MAKE SURE IT IS PERFECTLY CLEAN.

Air filter

REMOVAL

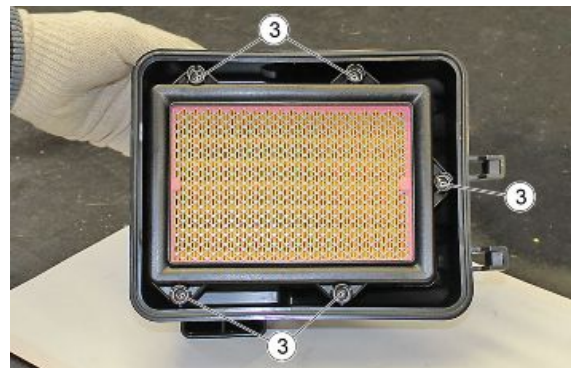
- Remove the saddle
- Remove the glove compartment
- Remove the side fairing panels
- Unhook and remove the four springs (1) located around the airbox filter, two in the upper area, one on the left side and one on the right side



- Remove the filter box (2)



- Unscrew and remove the screws (3)



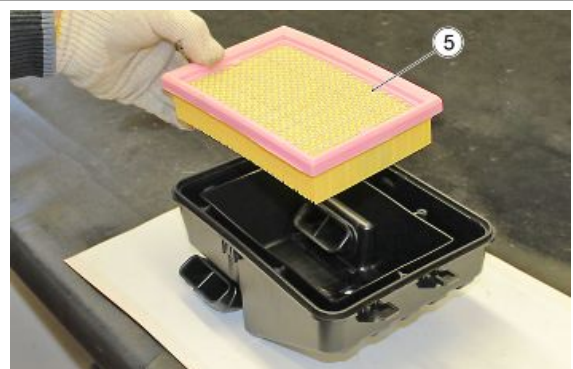
- Remove the cover (4).



- Remove the filter element (5)



**DO NOT START THE ENGINE WITH THE AIR FILTER REMOVED.
TO CLEAN THE FILTERING ELEMENT, USE A PRESSURISED JET OF AIR, AIMING IT FROM THE INSIDE OUTWARD.**



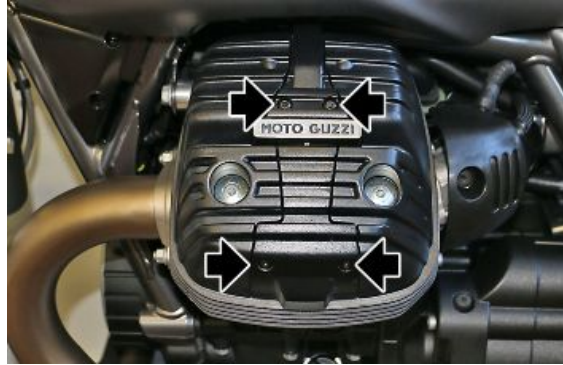
Checking the valve clearance

If the timing system is very noisy, check the clearance between the valves and the rocking levers.

NOTE

ADJUST WITH COLD ENGINE, WITH PISTON AT TOP DEAD CENTRE (TDC) IN COMPRESSION STROKE (VALVES CLOSED).

- Initially check the valve clearance in the left cylinder, then remove the four fixing screws of the spark plug cover



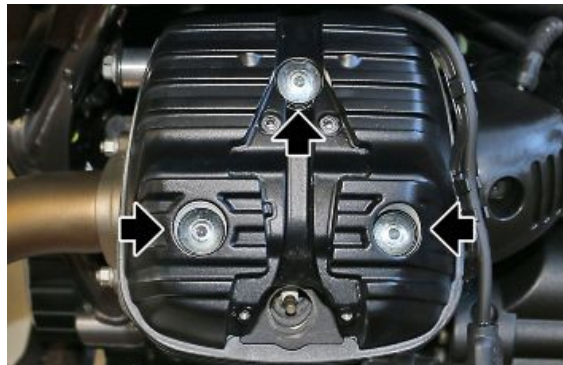
- Remove the spark plug cover



- Remove the spark plug tube



- Remove the three head cover fixing screws



- Remove the head cover



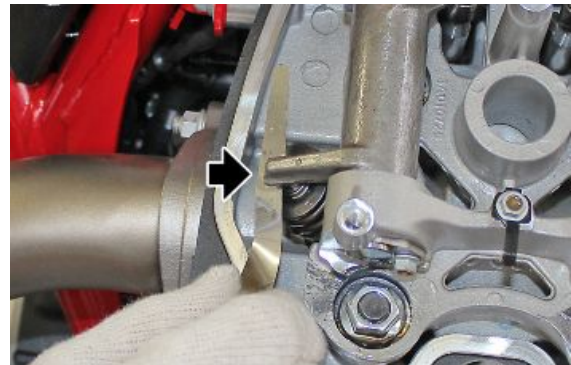
- Remove the spark plug

ALSO REMOVE THE SPARK PLUG OF THE RIGHT CYLINDER TO BE ABLE TO MANUALLY ROTATE THE ENGINE, ENGAGE THE FIRST GEAR AND TURN THE REAR WHEEL

- Intercept the top dead centre checking that the rockers have clearance to be able to measure it



- Use a feeler gauge to check that the clearance between the valve and the set screw corresponds with the indicated values. The corresponding intake and outlet valve clearances are different than what is indicated below, proceed with adjusting them.



Characteristic

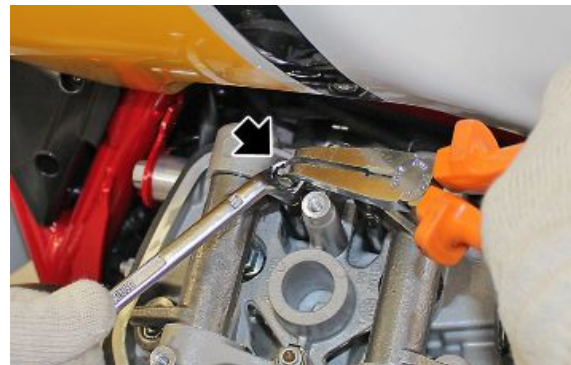
Intake valve clearance

0.10 mm (0.0039 in)

Exhaust valve clearance

0.15 mm (0.0059 in)

- Loosen the lock nut, adjust the clearance by acting on the adjuster until reaching the prescribed values
- Tighten the lock nut



- To perform the valve clearance of the right cylinder, it is necessary to bring the cylinder to the top dead centre, rotating the engine 270 degree

Top-up

FRONT BRAKE

- Unscrew and remove the screws (1)



- Remove the cover (2).



- Remove the diaphragm (3) and the gasket (4)



- Top up



REAR BRAKE

- Undo and remove the screw (1)



- Remove the bracket (2)



- Unscrew and remove the cap (3)



- Remove the gasket (4)



RISK OF BRAKE FLUID SPILLING. DO NOT OPERATE THE BRAKE LEVER IF THE BRAKE FLUID RESERVOIR CAP IS LOOSE OR HAS BEEN REMOVED.

CAUTION



AVOID PROLONGED AIR EXPOSURE OF THE BRAKE FLUID. BRAKE FLUID IS HYGROSCOPIC AND ABSORBS MOISTURE WHEN IN CONTACT WITH AIR. LEAVE THE BRAKE FLUID RESERVOIR OPEN ONLY FOR THE TIME NEEDED TO COMPLETE THE TOPPING-UP PROCEDURE.



TO AVOID SPILLING FLUID WHILE TOPPING-UP, KEEP THE TANK PARALLEL TO THE RESERVOIR EDGE (IN HORIZONTAL POSITION).

DO NOT ADD ADDITIVES OR OTHER SUBSTANCES TO THE FLUID.

WHEN USING A FUNNEL OR ANY OTHER ELEMENT, MAKE SURE IT IS PERFECTLY CLEAN.



WHEN TOPPING UP, DO NOT EXCEED THE "MAX" LEVEL.

TOPPING UP TO THE "MAX" LEVEL MUST BE CARRIED OUT ONLY WITH NEW PADS. DO NOT TOP UP TO THE "MAX" LEVEL WITH WORN PADS BECAUSE THIS WILL CAUSE FLUID TO LEAK OUT IN THE EVENT OF BRAKE PAD REPLACEMENT.

CHECK BRAKING EFFICIENCY. IN THE EVENT OF EXCESSIVE BRAKE LEVER TRAVEL OR A LOSS OF EFFICIENCY WITH THE BRAKING SYSTEM, THE BRAKING SYSTEM MAY NEED TO BE BLED.

Clutch system

Adjusting the lever

It is possible to adjust the distance between the end of the lever (1) and the grip (2), turning the adjuster (3).

- Push the control lever (1) forwards and turn the adjuster (3) until the lever (1) is at the desired distance.
- Turning the adjuster anticlockwise, the lever (1) gets closer to the grip (2).

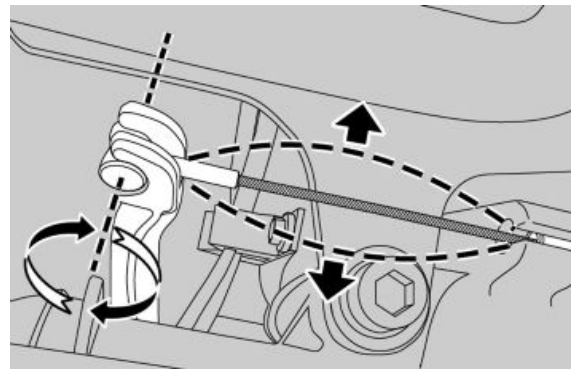


Adjust the clutch when the engine stops or the vehicle tends to move forward even when clutch lever is operated and the gear engaged, or if the clutch "slides", resulting in acceleration delay considering the engine revs.

- In order to maintain a correct tension and an optimal clutch operation, it is necessary to check and if necessary provide tension to the cable:
- Urban use every 1,000 km (621.37 mi)
- Extra urban use every 5,000 km (3,106.86 mi)
- In any case, every time you detect that the clutch has disengaged before the standard factory setting.

To adjust, do the following:

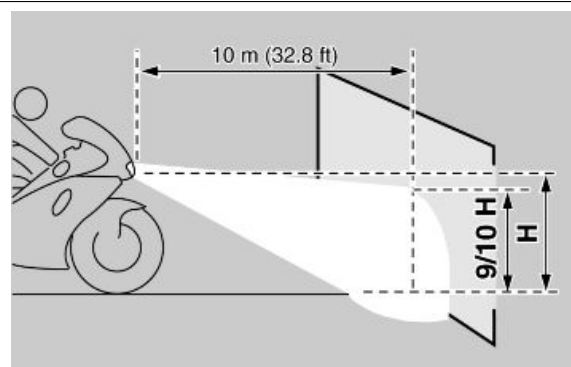
- Loosen the ring nut (4)
- Turn the set screw (5) with straight handlebar until the empty travel corresponding to the fixed abutment on the handlebar is 2 mm (0.08 in)
- Push the clutch control lever placed on the gearbox towards the rear wheel
- Pull the clutch control lever placed on the gearbox towards the opposite side (as in "point 3") checking that the cable is not tightened.
- During the previous operation, check that the cable lug turns freely around its axis, regarding the clutch lever
- Tighten the ring nut (4), holding the adjuster nut (5) to prevent it from turning
- If after the adjustment it is not possible to ascertain the condition of "point 5", contact an Authorised Moto Guzzi Dealer to verify the proper operation of the clutch control.
- If the adjuster stroke (5) is not sufficient to ensure the required clearance, contact an Authorised Moto Guzzi Dealer



Headlight adjustment

To carry out vertical adjustment of the light beam:

- Stand the motorcycle in a vertical position.
- Slightly loosen the headlight fixing screws (1) on both sides.

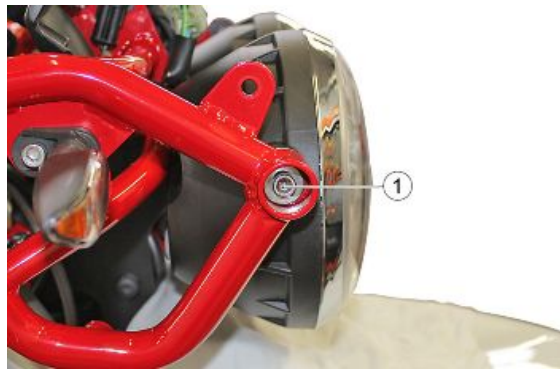


- Slightly loosen the headlight fixing screw (2), and move the light beam manually to the desired position.
- Once adjusted, tighten all the screws.

After adjusting:

NOTE

CHECK THAT THE LIGHT BEAM VERTICAL DIRECTION IS CORRECT.



For a quick check of the correct direction of the front light beam:

- Place the vehicle 10 m (32.81 ft) away from a vertical wall and make sure the ground is level.
- Turn on the low beam light, sit on the vehicle and check that the light beam projected to the wall is a little below the headlight horizontal straight line (about 9/10 of the total height).



INDEX OF TOPICS

ELECTRICAL SYSTEM

ELE SYS

Electrical system installation

INTRODUCTION

Scope and applicability

The wiring routing, its positioning and fastening to the motorcycle and potential problems are defined on the following section in order to reach the objectives of vehicle reliability.

Materials used and corresponding quantities

The electrical system consists of the following wiring harnesses and parts:

- 1 x Main Cable Harness
- 1 x Taillight wiring
- 1 x Fuel pump wiring
- 1 x Left cylinder HV wire
- 1 x Right cylinder HV wire
- 1 x Fog light wiring (not standard)

Consumable such as cable clamps, cable fasteners or cable grommets are indicated in the images

Motorcycle division

The wiring harnesses on the vehicle are subdivided into three main sections, as indicated in the figure.

1. Front section
2. Central section
3. Rear section



SPECIAL CHECKS FOR THE CORRECT CONNECTION AND LAYING OF CABLES

It is extremely important that any security-locks for the following connectors are properly connected and correctly tightened to ensure proper engine, and therefore proper vehicle, operation.

Carry out the checks listed below.

- Instrument panel connector
- Right and left injector connector

CAUTION



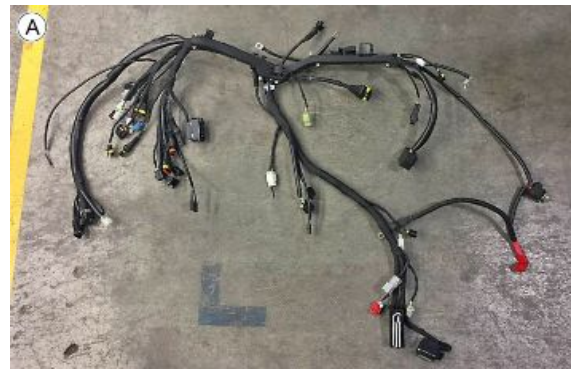
THE ENCIRCLED CONNECTORS ARE CONSIDERED CRITICAL IN COMPARISON WITH ANY OTHER BECAUSE THE VEHICLE WILL STOP OR PRESENT A MALFUNCTION IF THEY ARE ACCIDENTALLY DISCONNECTED.

Undoubtedly the connection of the rest of connectors is also important and essential for the correct operation of the vehicle. It is also important and essential that the instructions regarding the routing and fixing of the wiring harness in the various areas are followed meticulously in order to guarantee functionality and reliability

The following procedures describe the operations necessary for pre-assembling the main wiring harness on the frame.

TABLE A - PRELIMINARY PHASES

- Proceed as indicated in the figure

**TABLE B - PRELIMINARY PHASES**

- Proceed as indicated in the figure

**TABLE C - PRELIMINARY PHASE**

- Proceed as indicated in the figure

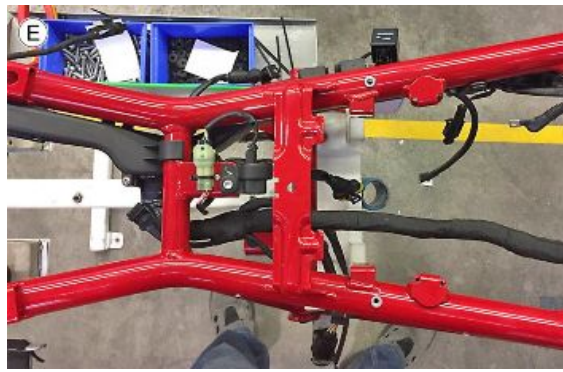
**TABLE D - PRELIMINARY PHASE**

1. Plastic rivet (female) + plastic rivet (male)



TABLE E - PRELIMINARY PHASE

- Proceed as indicated in the figure

**TABLE F - PRELIMINARY PHASE**

1. Medium sized clamp

**TABLE G - PRELIMINARY PHASE**

1. Medium sized clamp

**TABLE H - PRELIMINARY PHASE**

- Arrange the wiring as illustrated in the figure



TABLE I - PRELIMINARY PHASE

- Arrange the wiring as illustrated in the figure

**TABLE J - PRELIMINARY PHASE**

- Arrange the wiring as illustrated in the figure

**TABLE K - ABS SYSTEM PRE-MOUNTING**

1. Large clamp (for canister filter)

**TABLE L - ABS SYSTEM PRE-MOUNTING**

1. Large clamp (for canister filter)
2. Medium sized clamp



TABLE M - ABS SYSTEM PRE-MOUNTING

1. Large clamp (for canister filter)
2. Medium clamps (pre-mounted for subsequent flywheel cables fastening)



TABLE N - ASSEMBLY OF FRAME UNIT TO ENGINE

1. Temperature bulb connector



TABLE O - ASSEMBLY OF FRAME UNIT TO ENGINE

1. Temperature bulb connector

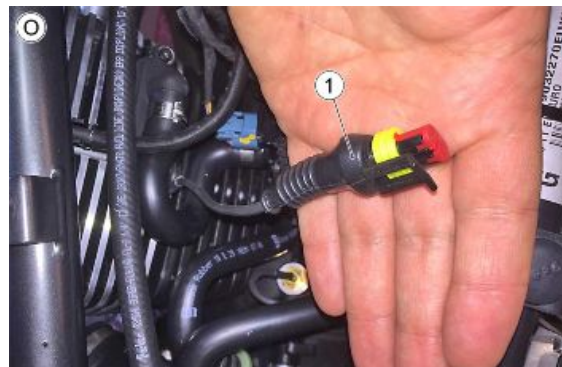


TABLE P - ASSEMBLY OF FRAME UNIT TO ENGINE

- Temperature bulbs connections carried out and objectified



TABLE Q - ASSEMBLY OF FRAME UNIT TO ENGINE

1. Gear in neutral switch



TABLE R - ASSEMBLY OF FRAME UNIT TO ENGINE

1. Pick up sensor rubber piece



TABLE S - ASSEMBLY OF FRAME UNIT TO ENGINE

1. Medium sized clamp
2. Large clamp



TABLE T - ASSEMBLY OF FRAME UNIT TO ENGINE

1. Fall sensor
2. Fuel pump

Pass the fall sensor and fuel pump outputs under the frame bracket as illustrated in the figure

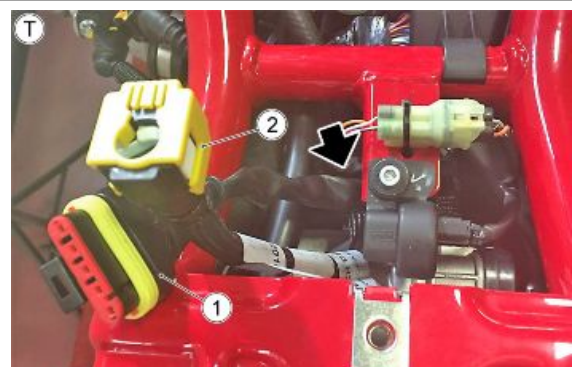


TABLE U - ASSEMBLY OF FRAME UNIT TO ENGINE

U

1. Large clamp

Pass the branch that goes to the instrument cluster over the frame crosspiece as illustrated in the figure



Front side

TABLE A - VOLTAGE REGULATOR ASSEMBLY

A

1. Regulator side flywheel cable
2. Regulator cable to wiring harness



TABLE A1 - VOLTAGE REGULATOR ASSEMBLY

A1

1. Medium clamps (previously mounted)
2. Engine side flywheel cable
3. Regulator side flywheel cable
4. Horn cable



TABLE A2 - VOLTAGE REGULATOR ASSEMBLY

A2

1. Horn connectors
2. Horn

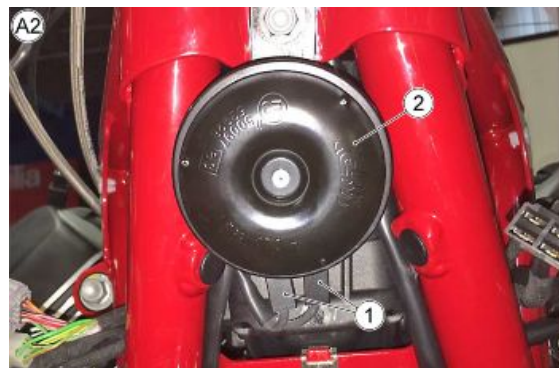


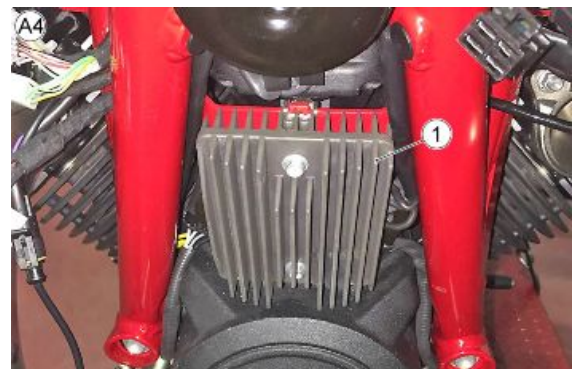
TABLE A3 - VOLTAGE REGULATOR ASSEMBLY

- Position the excess cable as illustrated in the figure

**TABLE A4 - VOLTAGE REGULATOR ASSEMBLY**

1. Voltage regulator

Fasten the voltage regulator as illustrated in the figure

**TABLE B - INSTRUMENT CLUSTER PRE-ASSEMBLY AND ASSEMBLY ON THE BIKE**

1. Air temperature sensor

Assemble the external air temperature sensor as the first operation

**TABLE B1 - INSTRUMENT CLUSTER PRE-ASSEMBLY AND ASSEMBLY ON THE BIKE**

1. Plug socket with rubber piece
2. Air temperature sensor

Assemble the turn indicators and run the wiring in the frame pipes

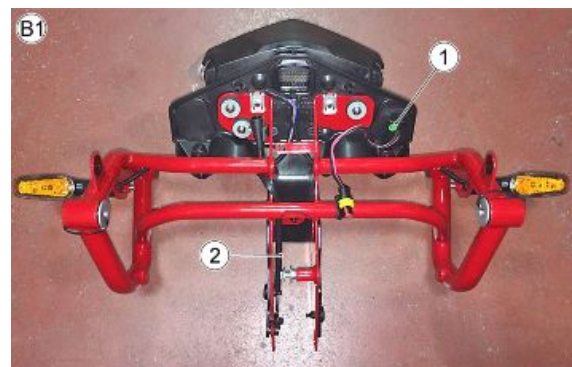


TABLE B2 - INSTRUMENT CLUSTER PRE-ASSEMBLY AND ASSEMBLY ON THE BIKE

1. Support for AMP connection
2. Small clamp



TABLE B3 - INSTRUMENT CLUSTER PRE-ASSEMBLY AND ASSEMBLY ON THE BIKE

1. Plug socket with rubber piece



TABLE B4 - INSTRUMENT CLUSTER PRE-ASSEMBLY AND ASSEMBLY ON THE BIKE

1. Small clamp
- Air temperature sensor fastenings

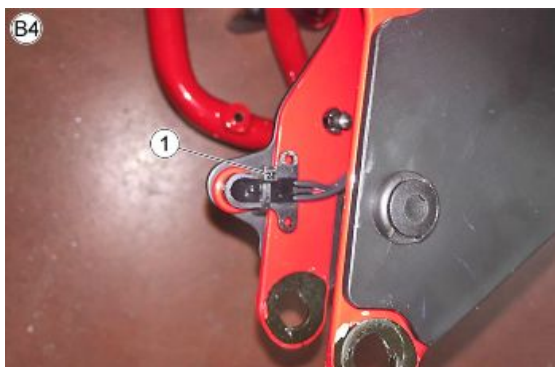


TABLE B5 - INSTRUMENT CLUSTER PRE-ASSEMBLY AND ASSEMBLY ON THE BIKE

1. Front right turn indicator connector
 2. Front left turn indicator connector
- Run the connections in the instrument cluster head

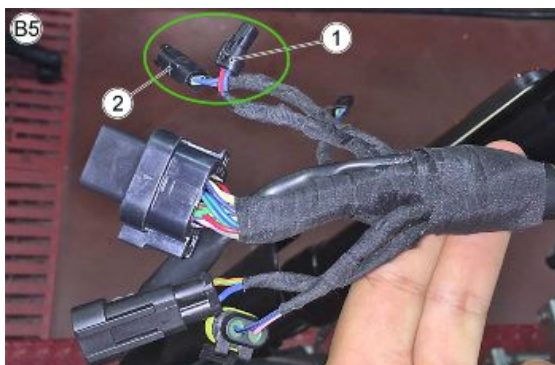


TABLE B6 - INSTRUMENT CLUSTER PRE-ASSEMBLY AND ASSEMBLY ON THE BIKE

B6

1. Wiring to the instrument cluster
2. Small clamp
3. Front speed sensor wiring



TABLE B7 - INSTRUMENT CLUSTER PRE-ASSEMBLY AND ASSEMBLY ON THE BIKE

B7

1. Air temperature sensor connection
 2. Power socket connection with rubber piece
- Both connections are objectivated with brackets for AMP connections



TABLE B8 - INSTRUMENT CLUSTER PRE-ASSEMBLY AND ASSEMBLY ON THE BIKE

B8

1. Instrument panel connector
2. Front headlamp connector

Assemble the front light cluster and, after connecting it, fastened the connector to the frame support as illustrated in the figure

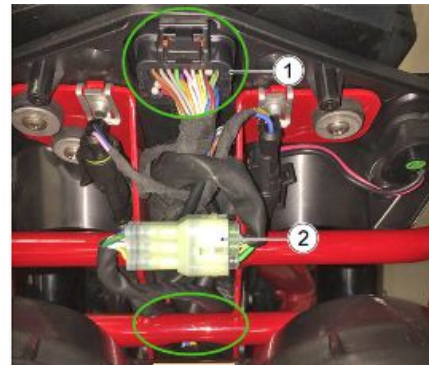


TABLE C - FRONT TURN INDICATORS

1. Right turn indicator connection

During installation one wire must be covered and the other with sheath



TABLE C1 - FRONT TURN INDICATORS

1. Left turn indicator connection

During installation one wire must be covered and the other with sheath

**TABLE C2 - FRONT TURN INDICATORS**

- Proceed as indicated in the figure

Once the turn connectors are connected, fasten the cables behind the instrument cluster

**TABLE D - HANDLEBAR**

1. Rubber cable guide

**TABLE D1 - HANDLEBAR**

1. Front stop switch



TABLE D2 - HANDLEBAR

1. Right light switch

**TABLE D3 - HANDLEBAR**

1. Left light switch

**TABLE D4 - HANDLEBAR**

1. Clutch switch

**TABLE E - FRONT WHEEL SPEED SENSOR**

1. Front speed sensor
2. Speed sensor fastening
3. Cable gland

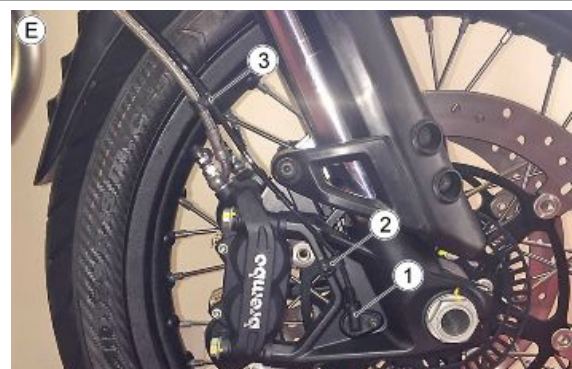


TABLE E1 - FRONT WHEEL SPEED SENSOR

- 1. Cable gland



TABLE E2 - FRONT WHEEL SPEED SENSOR

- 1. Cable gland



TABLE E3 - FRONT WHEEL SPEED SENSOR

- 1. Clip



TABLE E4 - FRONT WHEEL SPEED SENSOR

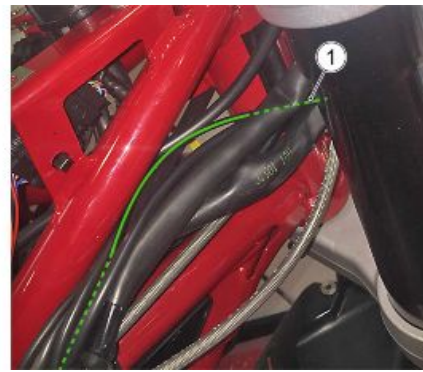
- 1. Speed sensor cable



TABLE E5 - FRONT WHEEL SPEED SENSOR

E5

1. Speed sensor cable



Central part

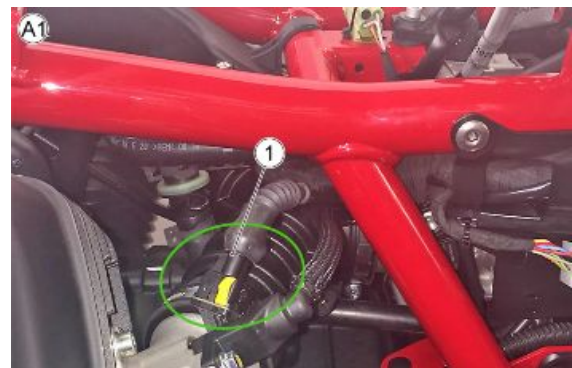
TABLE A - RIGHT INJECTOR CABLE ROUTING

1. Right injector connector

The cable must run as illustrated in the figure

**TABLE A1 - LEFT INJECTOR CABLE ROUTING**

1. Left injector connector

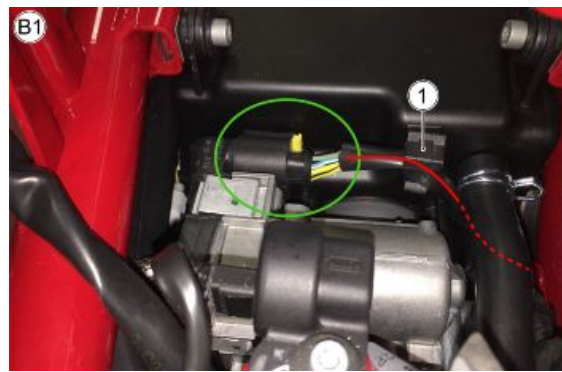
**TABLE B - FILTER BOX AND THROTTLE BODY CONNECTIONS**

1. Throttle valve cable

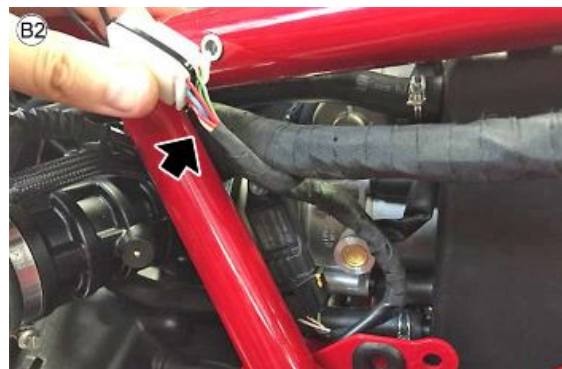


**TABLE B1 - FILTER BOX AND THROTTLE
BODY CONNECTIONS**

1. Fastener clip

**TABLE B2 - FILTER BOX AND THROTTLE
BODY CONNECTIONS**

- Pull the following cable to the outside of the frame

**TABLE B3 - FILTER BOX AND THROTTLE
BODY CONNECTIONS**

- Pull the following cable to the outside of the frame

**TABLE C - SIDE STAND SWITCH AND COR-
RECT ASSEMBLY ON THE VEHICLE**

- Overall view of pre-assembly



TABLE C1 - SIDE STAND SWITCH AND CORRECT ASSEMBLY ON THE VEHICLE

1. Fastener clip



TABLE C2 - SIDE STAND SWITCH AND CORRECT ASSEMBLY ON THE VEHICLE

1. Clip



TABLE C3 - SIDE STAND SWITCH AND CORRECT ASSEMBLY ON THE VEHICLE

1. Fastener clip



TABLE C4 - SIDE STAND SWITCH AND CORRECT ASSEMBLY ON THE VEHICLE

1. Side stand cabling

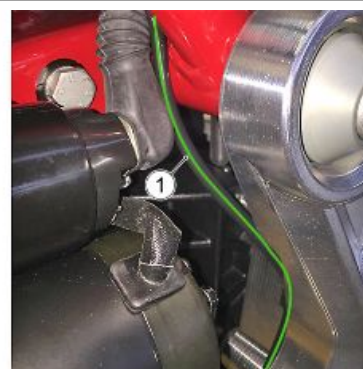


TABLE C5 - SIDE STAND SWITCH AND CORRECT ASSEMBLY ON THE VEHICLE

1. Side stand cabling



TABLE C6 - SIDE STAND SWITCH AND CORRECT ASSEMBLY ON THE VEHICLE

- Proceed as indicated in the figure

Fasten the side support on the frame (upper part)



TABLE C6 - SIDE STAND SWITCH AND CORRECT ASSEMBLY ON THE VEHICLE

- Proceed as indicated in the figure

Fasten the side support on the frame (upper part)

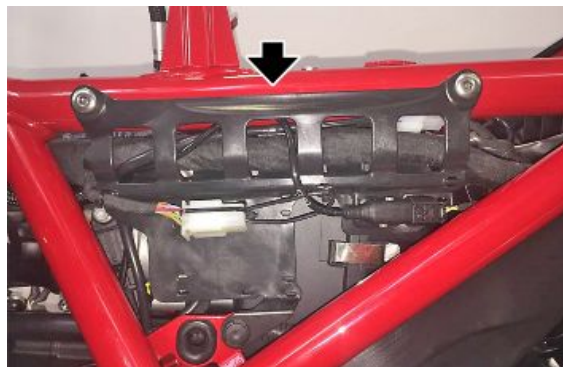


TABLE D - BRAKE LIGHT SWITCH AND CORRECT ASSEMBLY ON THE VEHICLE

- Overall view



TABLE D1 - BRAKE LIGHT SWITCH AND CORRECT ASSEMBLY ON THE VEHICLE

1. Brake light switch support



TABLE D2 - BRAKE LIGHT SWITCH AND CORRECT ASSEMBLY ON THE VEHICLE

1. Gearbox in neutral switch connection (mounted on support)
2. Brake light switch



TABLE D3 - BRAKE LIGHT SWITCH AND CORRECT ASSEMBLY ON THE VEHICLE

1. Support for AMP connection
2. Small clamp



TABLE E - HIGH VOLTAGE CABLES

1. Left cylinder H.V. cable
- H.V. cable route



TABLE E1 - HIGH VOLTAGE CABLES

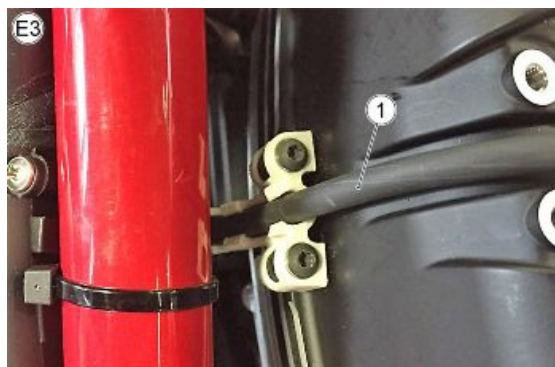
1. Left cylinder cable guide

**TABLE E2 - HIGH VOLTAGE CABLES**

1. Left cylinder coil connector
H.V. cable route to the left cylinder coil

**TABLE E3 - HIGH VOLTAGE CABLES**

1. Right cylinder H.V. cable
H.V. cable route

**TABLE E4 - HIGH VOLTAGE CABLES**

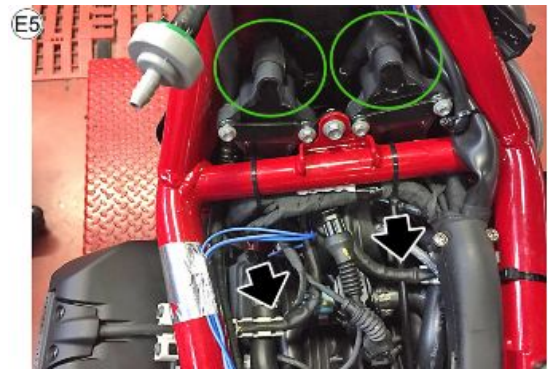
1. Right cylinder cable guide



TABLE E5 - HIGH VOLTAGE CABLES

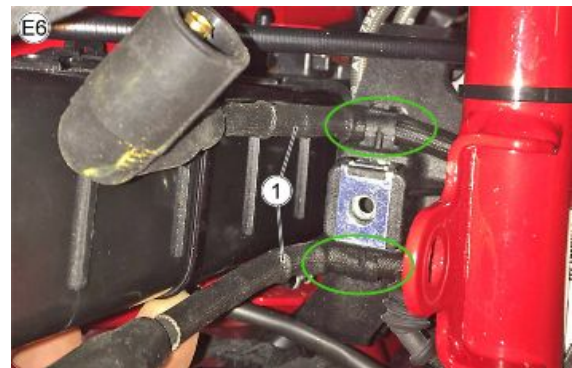
- Proceed as indicated in the figure

Overall view of how the two H.V. cables look with the respective cable guides indicated in the figure

**TABLE E6 - HIGH VOLTAGE CABLES**

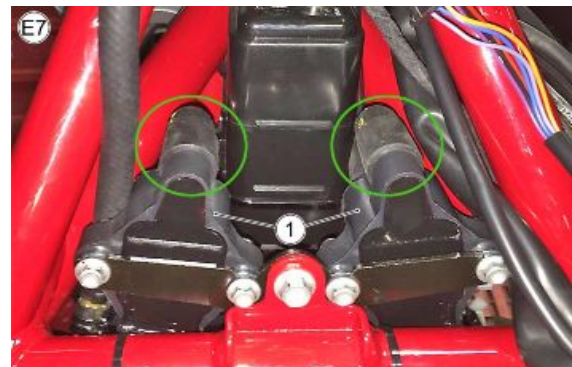
1. H.V. cables

The two H.V. cables must be fastened under the specific clips located in the ABS modulator support

**TABLE E7 - HIGH VOLTAGE CABLES**

1. Coils

View of completed coils assembly

**TABLE F - ABS**

1. ABS control unit connector

Does not require dust boot. For correct connection, see "installation of the ABS modulator"



FIGURE G - STARTER MOTOR

1. Start relay cable

**FIGURE G1 - STARTER MOTOR**

1. Power cable

Fasten the power cable to the clamp with nut and washer and cover everything with the specific black cap

**FIGURE G2 - STARTER MOTOR**

1. Power cable

**FIGURE G3 - STARTER MOTOR**

- Proceed as indicated in the figure



TABLE H - EARTH POINT ON ENGINE

1. Earth cable

**TABLE H1 - EARTH POINT ON ENGINE**

1. Earth cable
2. Nut

Fasten everything as illustrated in the figure

**TABLE I - RIGHT SIDE PANEL**

1. Rear switch connector
2. Neutral switch connector

The neutral switch connection is fastened in its specific support

**TABLE I1 - RIGHT SIDE PANEL**

1. Support for AMP connection
2. Small clamp

Fasten the excess brake light switch cable as illustrated in the figure

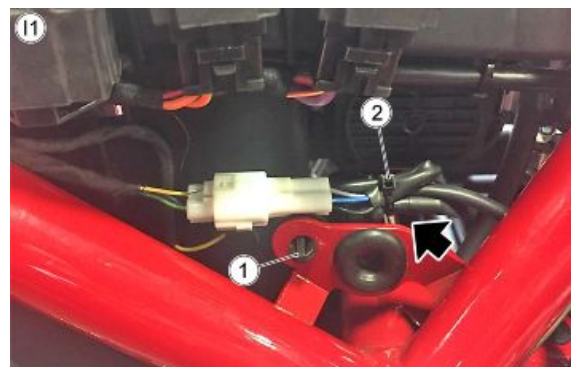


TABLE I2 - RIGHT SIDE PANEL

- Proceed as indicated in the figure



Back side

TABLE A - WIRING ON THE SEAT PILLAR

1. Medium sized cable ties

Once the lower seat pillar closing is mounted, remove the two clamps (1)

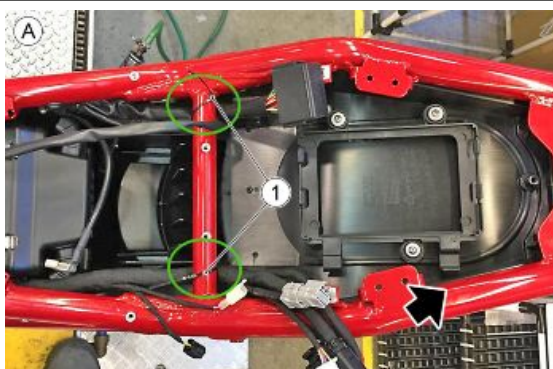


TABLE A1 - WIRING ON THE SEAT PILLAR

- Proceed as indicated in the figure



TABLE A2 - WIRING ON THE SEAT PILLAR

1. Engine control unit

Connect the engine ECU (1) and hook it to the specific plastic base



TABLE A3 - WIRING ON THE SEAT PILLAR

1. Secondary fuses

Fasten the secondary fuses box in the specific supports, taking care to run the wiring on the external side

**TABLE A4 - WIRING ON THE SEAT PILLAR**

1. Battery

Place the battery as illustrated in the figure

**TABLE A5 - WIRING ON THE SEAT PILLAR**

1. USB 2 power socket predisposition
2. Main fuses
3. Battery cover (mounted)

Fasten the USB2 power socket predisposition in the specific support and the main fuses as illustrated in the figure

**TABLE B - COMPLETE TAILLIGHT AND LICENCE PLATE HOLDER (PRE-ASSEMBLY)**

1. Licence plate holder

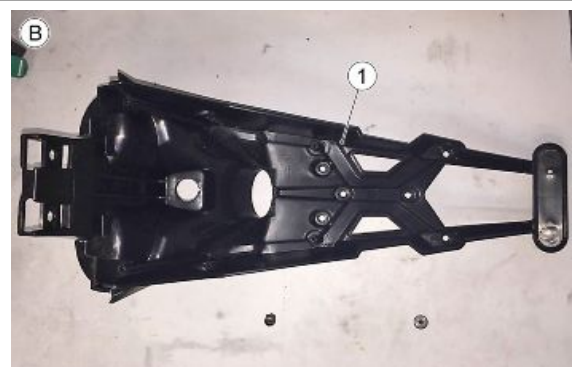
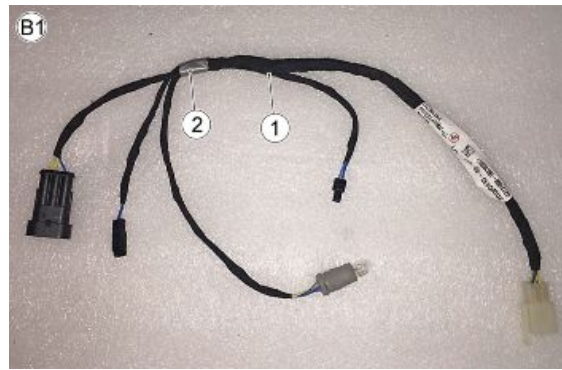


TABLE B1 - COMPLETE TAILLIGHT AND LICENCE PLATE HOLDER (PRE-ASSEMBLY)

1. Taillight wiring harness
2. Grey reference for positioning

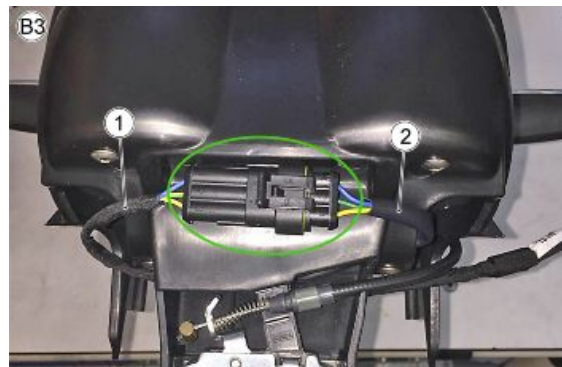
**TABLE B2 - COMPLETE TAILLIGHT AND LICENCE PLATE HOLDER (PRE-ASSEMBLY)**

1. Fastening clip
2. Grey reference for positioning

**TABLE B3 - COMPLETE TAILLIGHT AND LICENCE PLATE HOLDER (PRE-ASSEMBLY)**

1. Wire from wiring harness
2. Taillight wire

Connect the taillight and hook it to the support

**TABLE B4 - COMPLETE TAILLIGHT AND LICENCE PLATE HOLDER (PRE-ASSEMBLY)**

1. Fastener clip
2. Licence plate light

Insert the licence plate light (2) in the specific lodging and connect the right indicator to the wiring harness. Arrange the cables as illustrated in the figure.



TABLE B5 - COMPLETE TAILLIGHT AND LICENCE PLATE HOLDER (PRE-ASSEMBLY)

1. Fastener clip



TABLE B6 - COMPLETE TAILLIGHT AND LICENCE PLATE HOLDER (PRE-ASSEMBLY)

1. Screws
2. Licence plate holder

Close the licence plate holder (2) with the specific cover, using the screws (1)

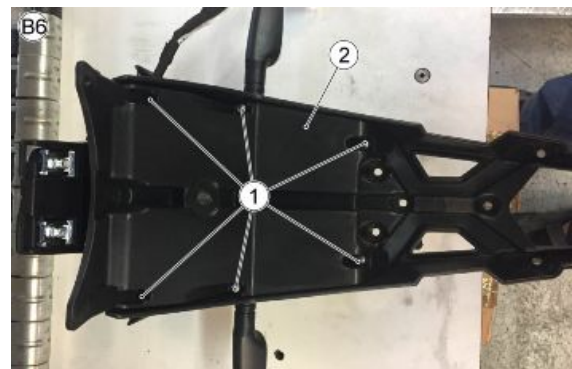


TABLE B7 - COMPLETE TAILLIGHT AND LICENCE PLATE HOLDER (PRE-ASSEMBLY)

1. Licence plate holder

Licence plate holder (1) complete and closed



TABLE C - REAR WHEEL SPEED SENSOR

1. Rear speed sensor
2. Speed sensor fastening
3. Cable gland

Run the wire inside the slot in the rubber cap



TABLE C1 - REAR WHEEL SPEED SENSOR

1. Clip
2. Cable gland

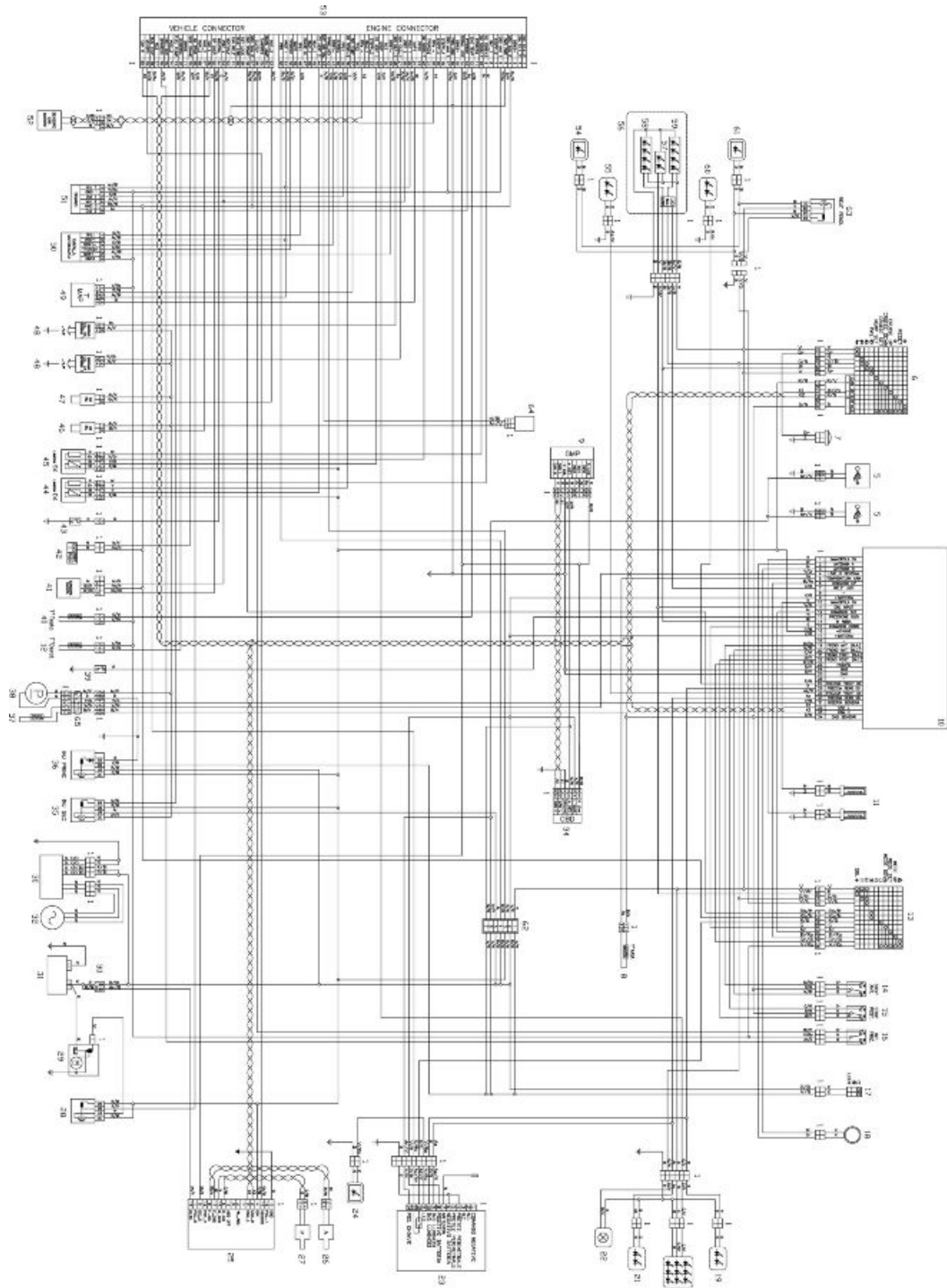
**TABLE C2 - REAR WHEEL SPEED SENSOR**

1. Small clamp
2. Speed sensor connector

Connection of the speed sensor is fastened with a clip



General wiring diagram



Key:

- 1. Multiple connectors
- 2. -
- 3. -
- 4. -

5. USB power sockets (not standard)
6. Left light switch
7. Horn
8. Air temperature sensor
9. Predisp. GMP/Tyre pressure
10. Instrument panel
11. Heated hand grips (not standard)
12. Derating Temp. Sens.
13. Right light switch
14. Frt. brake switch.
15. Rear brake switch.
16. Clutch switch
17. Ignition switch
18. Immobilizer antenna
19. Right rear turn indicator
20. Tail light
21. Left rear turn indicator
22. Licence plate light
23. Antitheft system (not standard)
24. Antitheft system LED
25. ABS control unit
26. Front ABS sensor
27. Rear ABS sensor
28. Starter motor relay
29. Starter motor
30. Voltage regulator
31. Battery
32. Alternator
33. Low fuel probe
34. OBD connector
35. Secondary injection relay
36. Primary injection relay
37. Fuel level sensor
38. Fuel pump
39. Oil pressure sensor
40. Head temperature Sens.
41. Fall Sens.
42. Stand switch

- 43.Neutral sensor
- 44.Right cylinder lambda
- 45.Left cylinder lambda
- 46.Right cylinder injector
- 47.Left cylinder injector
- 48.Coils
- 49.T-Map sensor
- 50.Motorised throttle valve
- 51.Demand sensor
- 52.Engine speed sensor
- 53.Engine control unit
- 54.Left fog light (not standard)
- 55.Left Frt. turn indicator
- 56.Front headlamp
- 57.Position lights and DRL
- 58.High beam LED module
- 59.Low beam LED module
- 60.Right Frt. turn indicator
- 61.Right fog light (not standard)
- 62.Secondary fuses
- 63.Fog light relay (not standard)
- 64.Secondary air system
- 65.Ferrite
- 66.-

Colour key:

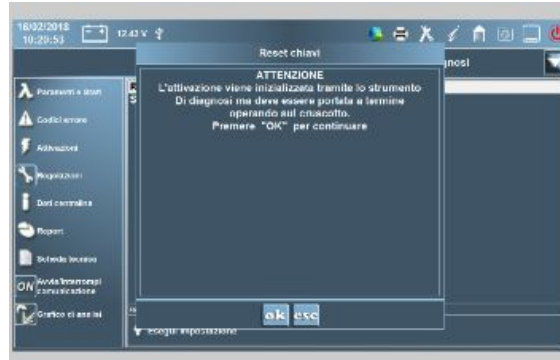
- Ar Orange
- Az Light blue
- B Blue
- Bi White
- G Yellow
- Gr Grey
- M Brown
- N Black
- R Red
- V Green
- Vi Violet
- Ro Pink

Storing new keys

NOTE

REGARDLESS OF THE LANGUAGE SET IN THE DASHBOARD FUNCTIONS, THE KEY PROGRAMMING PROCEDURE CAN ONLY BE VIEWED IN ENGLISH.

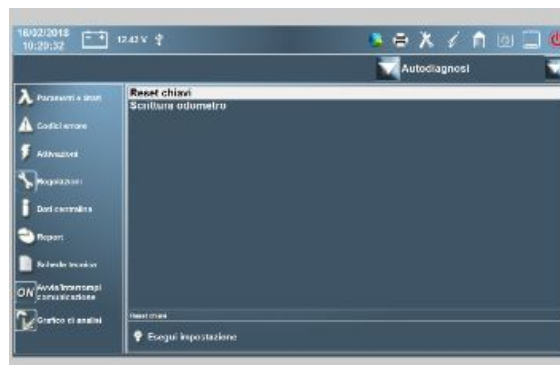
- To carry out the one or more key programming procedures, up to a maximum of four, you must connect the motorcycle to the diagnostic tool.
- Turn key to "ON" and insert the USER CODE where required.
- Carry out the self-diagnosis of the dashboard and enter the "SETTINGS" section by clicking on "RESET KEYS".



- At this point, a screen with a warning message will be visible. Press "OK" and start programming the keys.

NOTE

IF THE IMMOBILIZER ANTENNA IS DISCONNECTED, YOU WILL NOT BE ABLE TO START KEY PROGRAMMING.



- Enter the USER CODE to continue.
- If the code entered is correct, the first key is stored.



- At this point, on the digital display of the motorcycle, after the automatic restart of the dynamic presentation screen, a message will appear with a countdown of 20 seconds to insert the second key to be programmed.
- Set key to "OFF", insert the second key and set to "ON".

**CAUTION**

IF YOU DO NOT HAVE A SECOND KEY OR YOU DON'T WANT TO STORE ONE, THE DIAGNOSTIC TOOL WILL SHOW AN ERROR SAYING "1 KEY STORED"

- The second key is stored and you will be asked to enter the third key (if you have one). The same operation will be repeated to store the fourth key.
- To complete AND end the memorisation procedure, set key to "OFF".
- You should then test the correct functioning of all keys stored.

**Azzeramento icona manutenzione**

The system displays the function as follows:

- After the maintenance interval thresholds are exceeded (excepting the first), an icon with the adjustable wrench is shown on the digital display.

To reset Service proceed as follows:

- Connect the diagnostic tool;
- Select the concerned model;
- Enter in the "INSTRUMENT PANEL" section;
- Select "SELF-DIAGNOSIS";
- Select "ACTIVATIONS";
- Enable the command "SERVICE RESET".



Fuses

To check:

- Set the ignition switch to 'OFF' to avoid an accidental short circuit.
- Remove the saddle.
- Remove the fuse box cover.
- Take out one fuse at a time and check if the filament is broken.
- Before replacing the fuse, find and solve, if possible, the reason that caused the problem.
- If the fuse is damaged, replace it with one of the same current rating.

NOTE

IF THE SPARE FUSE IS USED, REPLACE WITH ONE OF THE SAME TYPE IN THE CORRESPONDING FITTING.

MAIN FUSES

Specification	Desc./Quantity
A) 30A fuse	Battery recharge, primary injection relay, key, injection loads, taillights, starter relay
B) 20A fuse	ABS power supply
L) spare fuses	

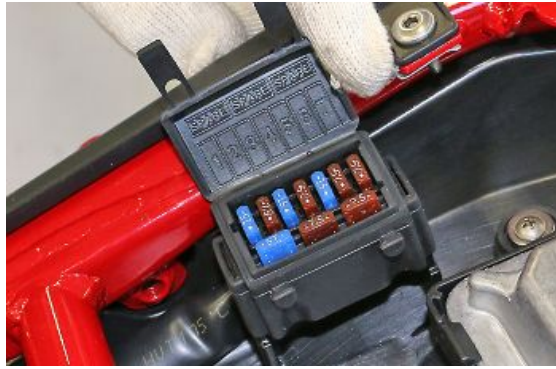
These are located underneath the saddle on the LH side



SECONDARY FUSES

Specification	Desc./Quantity
C) 15A fuse	Low beam/high beam and passing lights, brake lights, DRL/taillights, horn, fog lights
D) 7.5A fuse	Instrument panel power supply, antitheft system power supply, hand grips and turn indicators
E) 15A fuse	ECU live positive lead
F) 7.5A fuse	ECU permanent positive lead
G) 15A fuse	Coils, secondary air injectors, fuel pump
H) 7.5A fuse	USB sockets, antitheft system
I) 7.5A fuse	Bluedash (GPS), OBD
L) spare fuses	

These are located underneath the saddle on the RH side



Control unit

REMOVAL

- Remove the saddle
- Unscrew and remove the screws (1)



- Disconnect the connectors (2)
- Remove the ECU (3)



NOTE

WHEN REASSEMBLING THE CONNECTORS, THE SLIDES MUST SLIDE FREELY UP TO THE LIMIT STOP, THUS FACILITATING THE CONNECTOR'S INSERTION. THE CATCH SHOULD SNAP INTO PLACE ONCE THE LIMIT STOP IS REACHED.

INDEX OF TOPICS

ENGINE FROM VEHICLE

ENG VE

Vehicle preparation

Before removing the engine from the vehicle, the following operations must be carried out:

- Place a suitable support under the vehicle and secure it using belts
- Remove the battery, the fuel tank, the rider footrest plates, the sump guard, the side stand, the complete exhaust system, the rear shock absorber and the side panels

Removing the engine from the vehicle

- Disconnect the connector (1)



- Disconnect the connector (2)



- Free the connector (2) from the wiring harness as illustrated in the figure



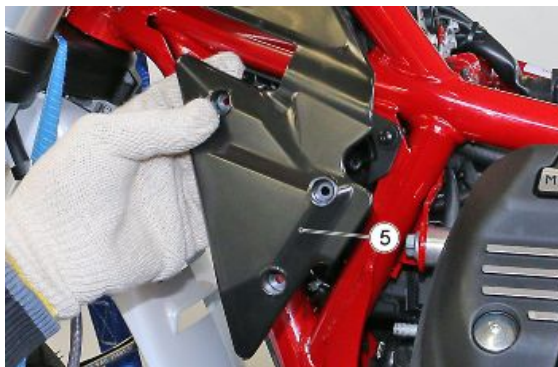
- Disconnect the connector (3)



- Unscrew and remove the screws (4)



- Remove the left headstock cover (5)



- Disconnect the connector (6)



- Remove the clamp (7)



- Unscrew and remove the screws (8)



- Remove the connectors box (9)



- Unscrew and remove the screws (10)



- Remove the injector cover (11)



- Undo and remove the screw (12)



- Remove the left injector (13)



- Remove the clamp (14)



- Unscrew and remove the screws (15)



- Remove the left intake fitting (16)
- Repeat the operations from "11" to "17" to remove the right inlet fitting



- Unscrew and remove the screws (17)



- Remove the starter motor cover (18)



- Lift the protective boot (19)



- Unscrew the nut (20) and remove it.



- Remove the cable (21)



- Disconnect the connector (22)



- Unscrew and remove the screws (23)



- Remove the starter motor (24).



- Disconnect the connector (25)



- Unscrew the nut (26) and remove it.
- Remove the cable (27) and (28)



- Unscrew and remove the screw (29)



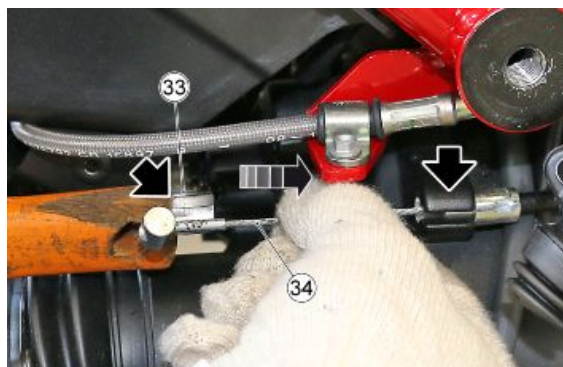
- Remove the oil pressure bulb cover (30)



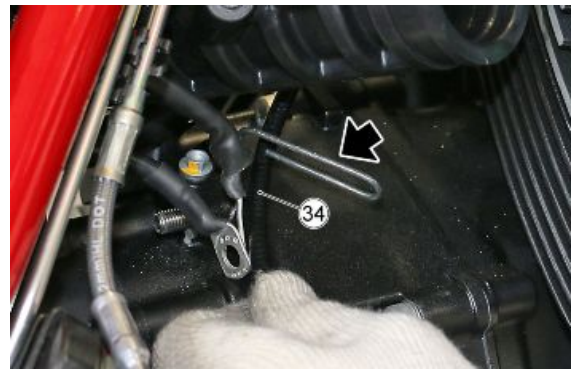
- Unscrew and remove the screw (31)
- Remove the cable (32) from the oil pressure bulb



- Press the lever (33) toward the front part of the vehicle, as illustrated in the figure, to eliminate the tension to which the clutch cable is subjected
- Simultaneously slide out and remove the clutch cable (34) from the points indicated in the figure



- Remove the clutch cable (34) from the cable grommet as indicated in the figure



- Remove the clutch cable (34) from the engine and frame area



- Disconnect the connector (35)



- Unscrew and remove the screws (36)



- Remove the cover (37).



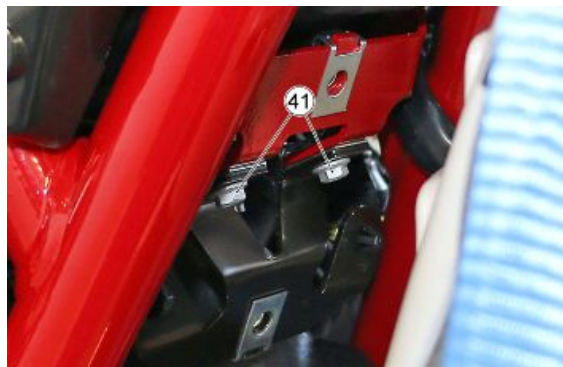
- Disconnect the spark plug cap (38)



- Unscrew and remove the screws (39)
- Remove the voltage regulator (40) from the frame and place it beside the vehicle



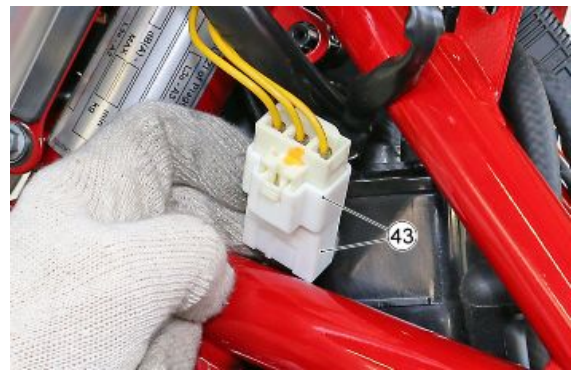
- Unscrew and remove the screws (41)



- Remove the voltage regulator support bracket (42)



- Disconnect the connector (43)



- Unscrew and remove the screws (44)



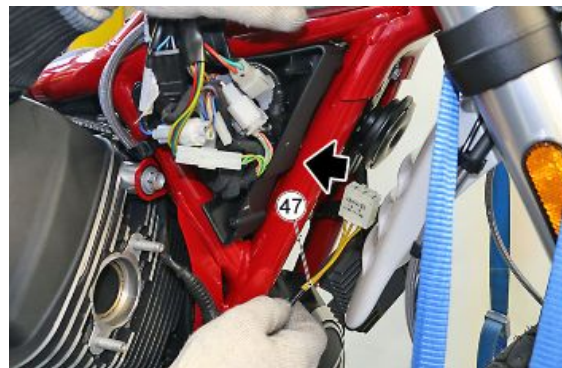
- Unscrew and remove the screws (45)



- Momentarily move the connectors box and remove the clamp (46)



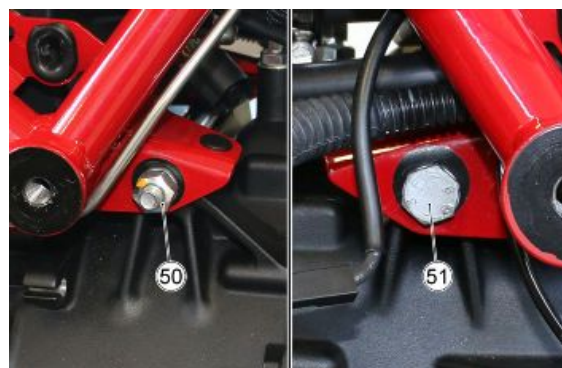
- Keeping the connectors box moved, remove the voltage regulator cable (47) from the frame area
- Remove the rear wheel
- Remove the swingarm
- Remove the cardan shaft



- Remove the pipe feedthrough (48)
- Disconnect the secondary air pipes (49)



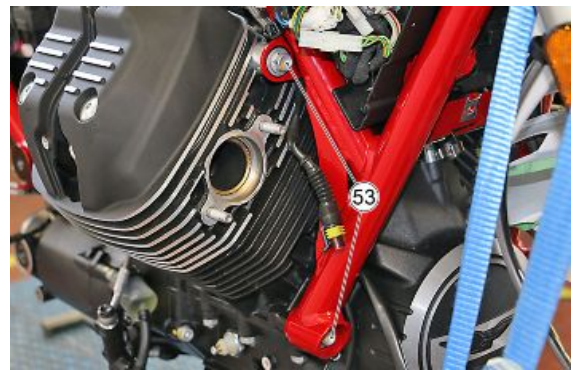
- Blocking the pin (51)
- Unscrew the nut (50) and remove it.
- Remove the pin (51)



- Unscrew and remove the screws (52)



- Unscrew and remove the screws (53)



- Retrieve the washer (54)



- Retrieve the washer (55)



- Remove the engine (56)



INDEX OF TOPICS

ENGINE

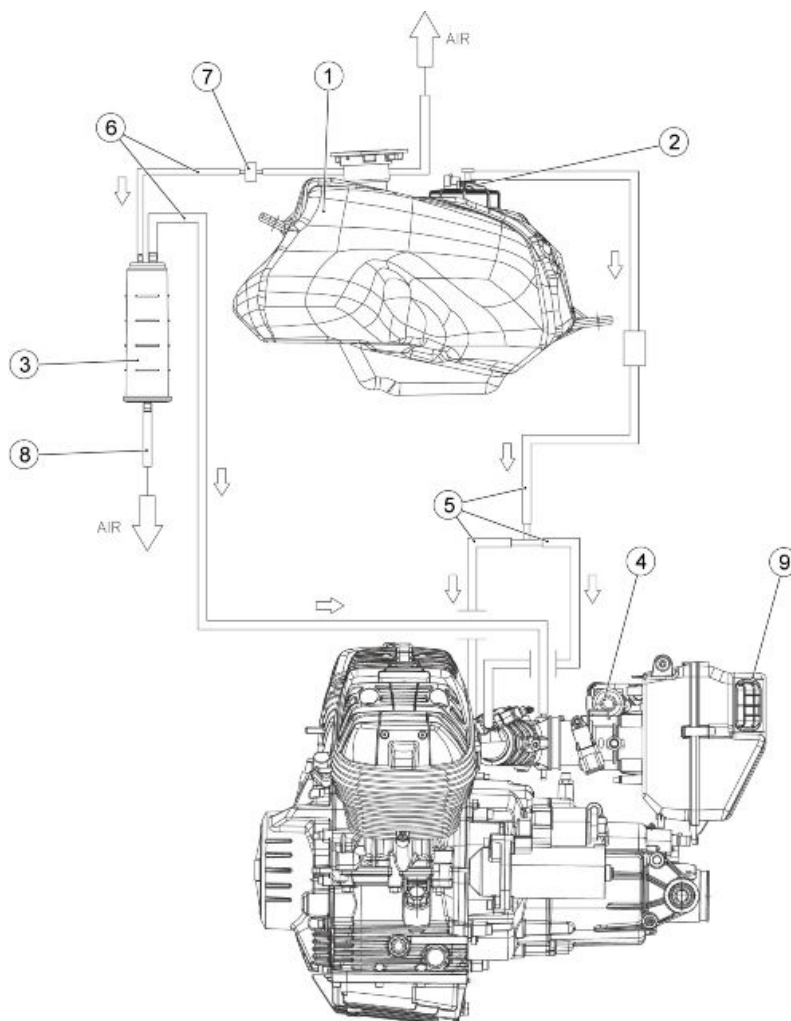
ENG

TO CONSULT THE CHAPTER ABOUT THE ENGINE AND ITS COMPONENTS PLEASE REFER TO THE APPROPRIATE MANUAL: "MSS Engine V85"

INDEX OF TOPICS

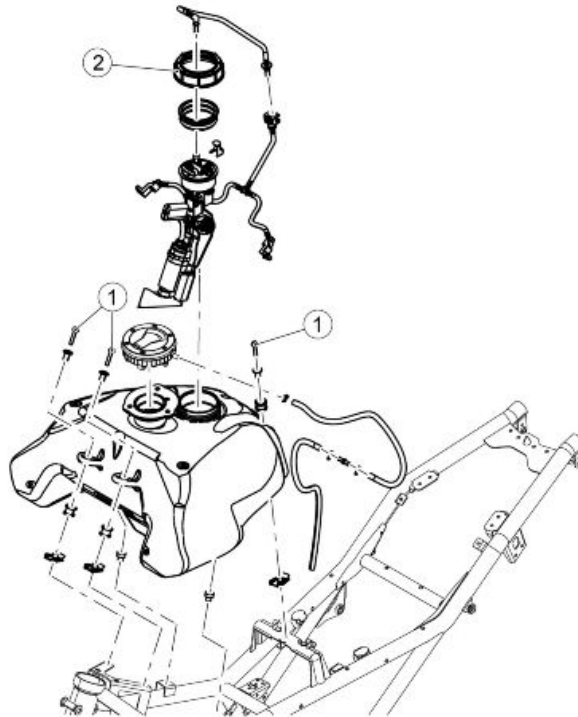
POWER SUPPLY

P SUPP

Circuit diagram**Key:**

1. Fuel tank
2. Fuel pump
3. Canister
4. Throttle body
5. Fuel delivery pipes
6. Fuel vapour recovery pipe
7. Check valve
8. Breather pipe
9. Intake

Fuel pump



SERBATOIO BENZINA

Pos.	Descrizione	Tipo	Quantità	Coppia	Note
1	Viti fissaggio serbatoio carburante a telaio	M6	3	10 Nm (7.38 lbf ft)	-
2	Ghiera fissaggio pompa carburante a serbatoio carburante	-	1	20 Nm (14.75 lbf ft)	-

Removing

- Remove the fuel tank
- Remove the side fairings
- Remove the central tank fairing
- Disconnect the connector (1)



- Remove the lock (2)



- Remove the hose (3)



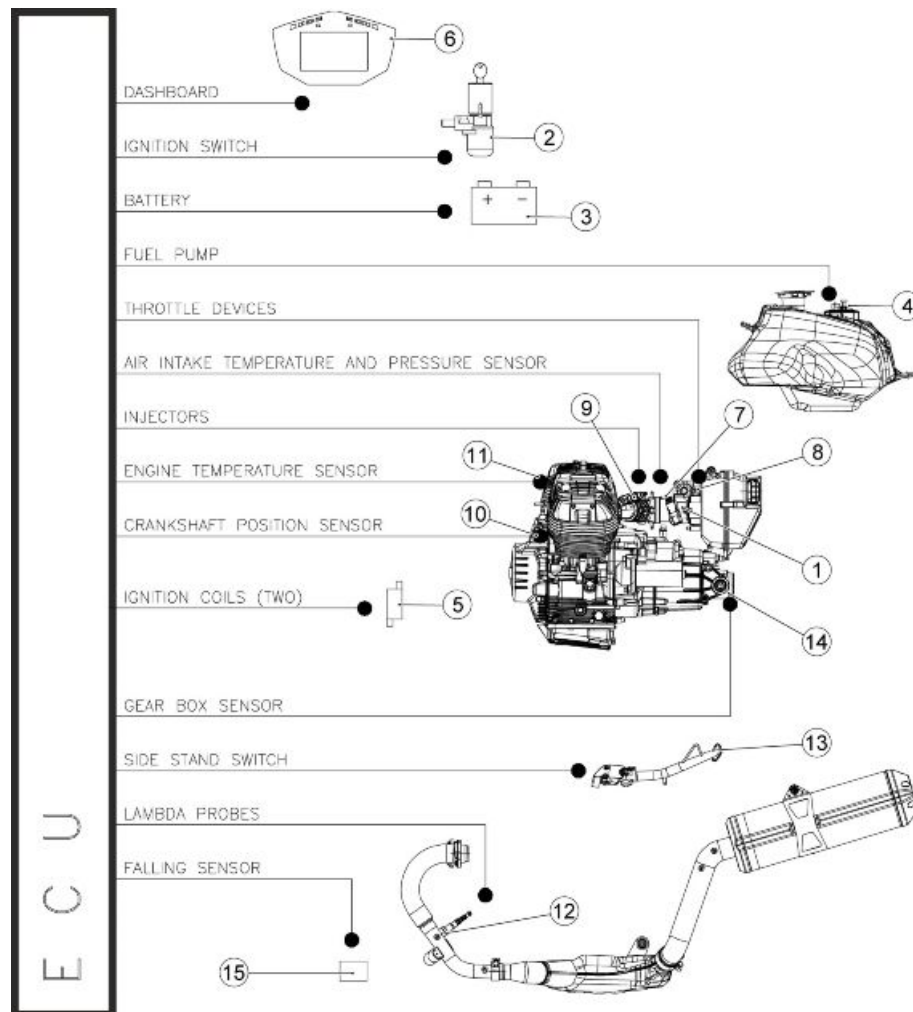
- Unscrew and remove the ring nut (4)



- Remove the fuel pump (5)



Diagram

**key:**

1. Control unit position
2. Ignition switch
3. Battery
4. Fuel pump
5. Coils
6. Instrument panel
7. Air temperature sensor
8. Throttle valve position sensor
9. Injectors
10. Crankshaft position sensor
11. Engine temperature sensor
12. Lambda probe
13. Side stand switch

14.Gear sensor

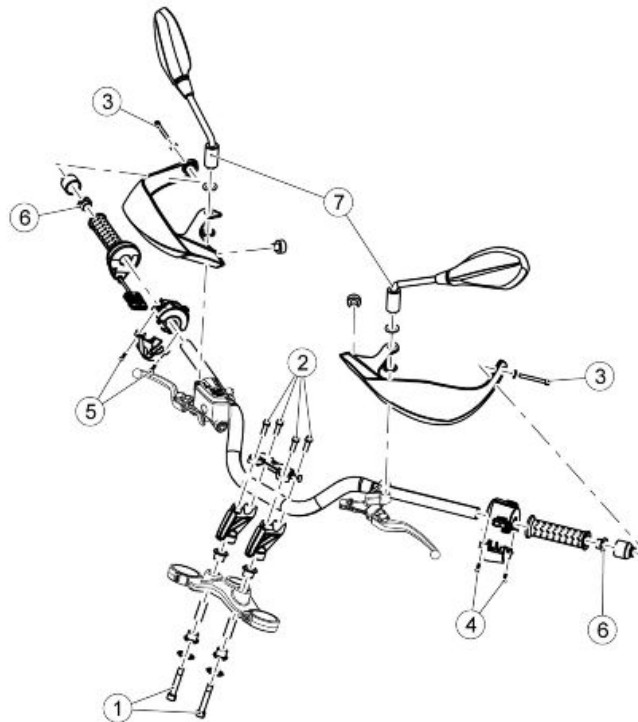
15.Fall sensor

INDEX OF TOPICS

SSUSPENSIONS

SUSP

Handlebar



MANUBRIO - COMANDI

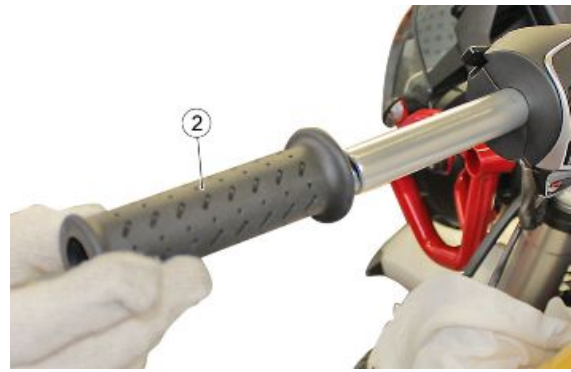
Pos.	Descrizione	Tipo	Quantità	Coppia	Note
1	Viti fissaggio cavallotti inferiori a piastra superiore di sterzo	M10	2	-	-
2	Viti fissaggio morsetto a cavallotti inferiori a manubrio	M8	4	-	-
3	Viti fissaggio paramani e pesi antivibranti a manubrio	M6	2	10 Nm (7.38 lbf ft)	-
4	Viti fissaggio guscio posteriore sinistro a blocchetto comando sinistro	M4	2	1.5 Nm (1.11 lbf ft)	Viti pre-montate sul guscio
5	Viti fissaggio guscio posteriore destro a blocchetto comando destro	M4	2	1.5 Nm (1.11 lbf ft)	Viti pre-montate sul guscio
6	Terminale fissaggio peso antivibrante a manubrio	-	2	10 Nm (7.38 lbf ft)	-
7	Fissaggio specchi retrovisori	-	2	Manuale	-
-	Viti fissaggio acceleratore comando elettronico a manubrio	M4	1	4 Nm (2.95 lbf ft)	Viti pre-montate sul comando gas

Removing

- Remove the rear view mirrors
- Remove the handguards
- Remove the front brake pump
- Remove the clutch pump
- Unscrew and remove the bushings (1) from both sides of the vehicle



- Remove the left hand grip (2)



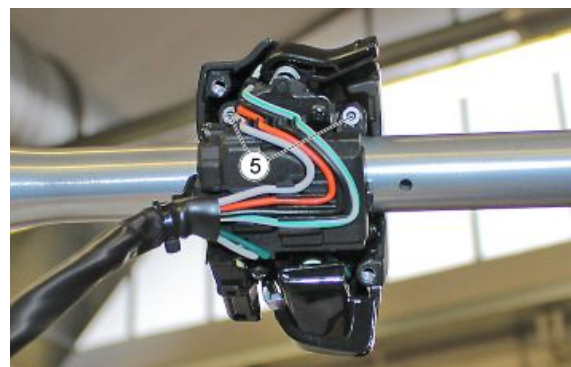
- Unscrew and remove the screws (3)



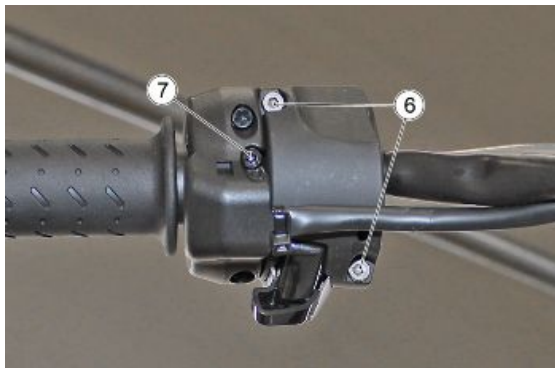
- Remove the left-hand lights switch cover (4)



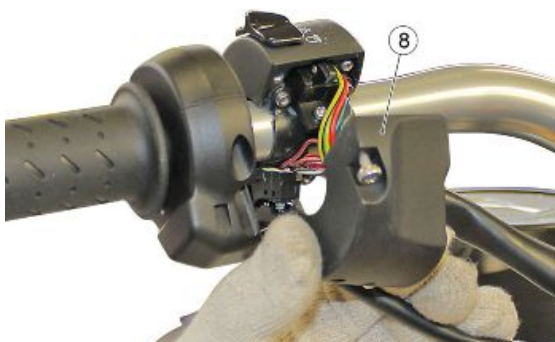
- Loosen the two screws (5)



- Unscrew and remove the screws (6)
- Loosen the screw (7)



- Remove the right-hand lights switch cover (8)



- Loosen the screws (9)



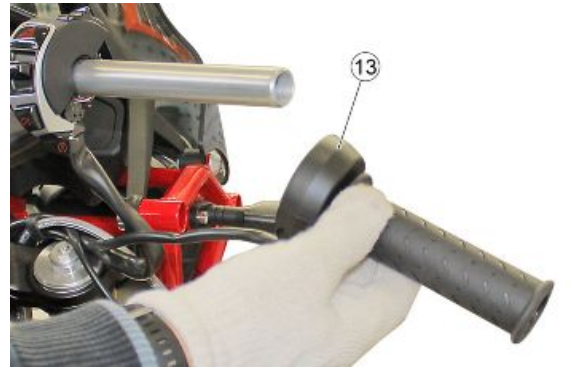
- Unscrew and remove the screws (10)
- Remove the U-bolt (11)



- Support the handlebar
- Remove the left-hand lights switch from the handlebar (12)



- Remove the throttle control from the handlebar (13)



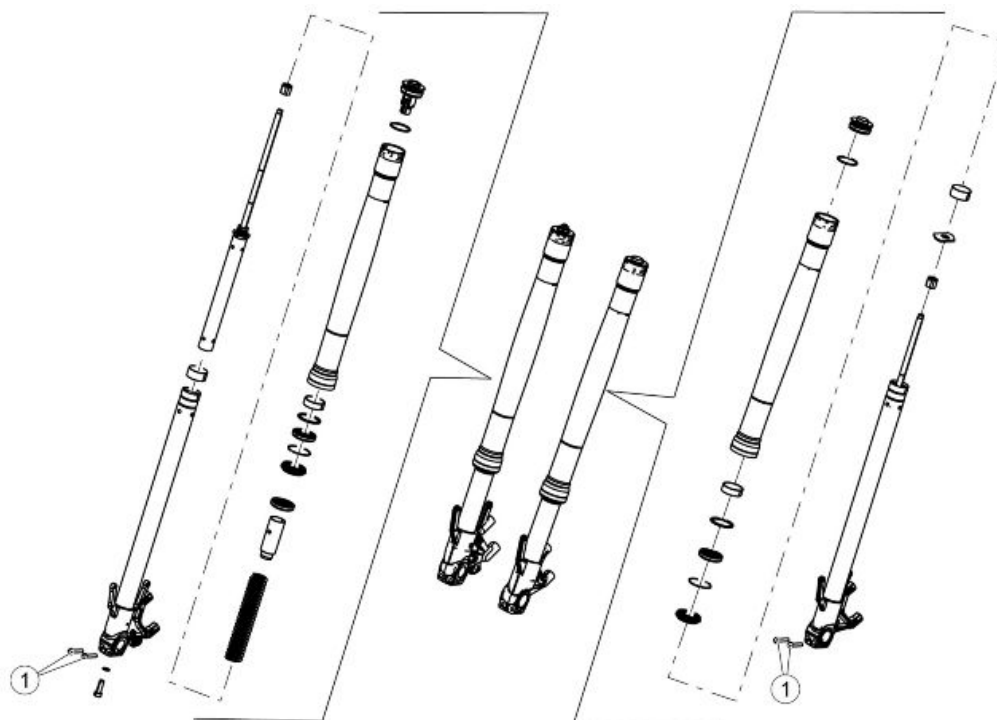
- Remove the right-hand lights switch from the handlebar (14)



- Remove the handlebar (15)

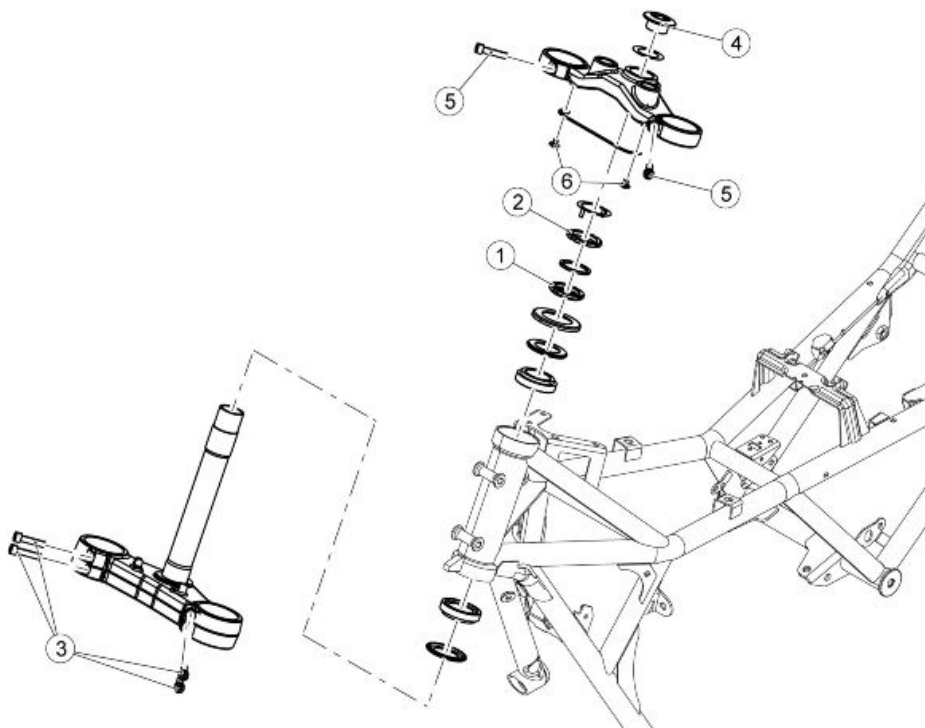


Front fork



FORCELLA ANTERIORE

Pos.	Descrizione	Tipo	Quantità	Coppia	Note
1	Viti fissaggio piedini forcella a perno ruota	M6	4	10 Nm (7.38 lbf ft)	-



STERZO

Pos.	Descrizione	Tipo	Quantità	Coppia	Note
1	Ghiera fissaggio assieme piastra inferiore/perno di sterzo a canotto	-	1	-	-
2	Controghiera fissaggio assieme piastra inferiore/perno di sterzo a canotto	-	1	-	-
3	Viti fissaggio steli forcella a piastra inferiore di sterzo	M8	4	-	-
4	Bussola fissaggio piastra superiore	-	1	-	-
5	Viti fissaggio steli forcella a piastra superiore di sterzo	M8	2	-	-
6	Viti fissaggio passacavo a piastra superiore di sterzo	M6	2	10 Nm (7.38 lbf ft)	-

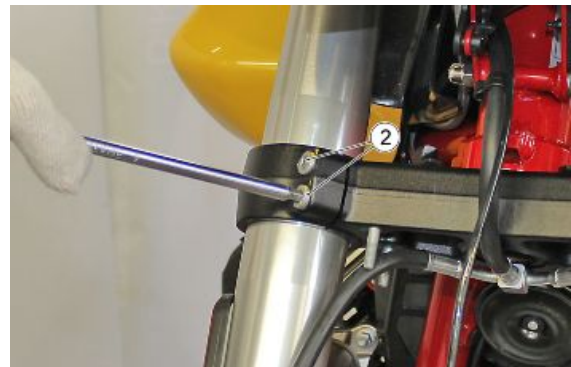
Removing the fork legs

The following procedure is described for a single fork stanchion, but is valid for both stanchions.

- Remove the front mudguard
- Remove the front wheel
- Loosen the screw (1)



- Loosen the two screws (2)



- Remove the fork stanchion (3)



Disassembling the fork

NOTE

THE STEMS ARE NOT THE SAME, THEREFORE THEY REQUIRE SEPARATE REMOVAL PROCEDURES.

THE FOLLOWING OPERATIONS APPLY WHEN REMOVING THE RIGHT HAND STEM

- Taking care not to damage it, secure the fork vertically in a vice, using the appropriate protection devices.
- Unscrew the upper cap (1).



Specific tooling

AP8140149 Guard for assembly operations

- Using the special tool (2), fastened to the pre-loading pipe (3), compress the spring and, with the assistance of a second operator, insert the separator plate (4) under the cap retaining nut (5).



Specific tooling

020888Y Preload tube clamp

AP8140148 Plunger-spacer separator plate

- Ensure that the cap (1) cannot rotate, and then loosen the nut (5).



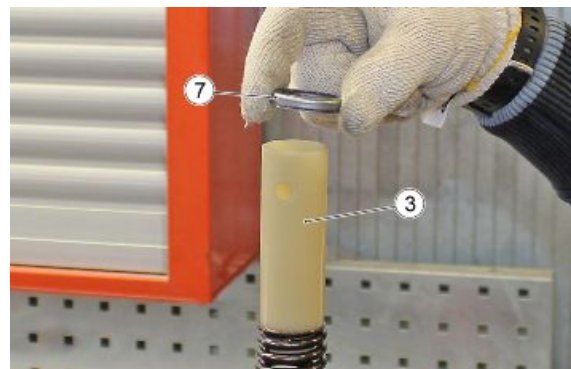
- Unscrew and remove the cap (1).



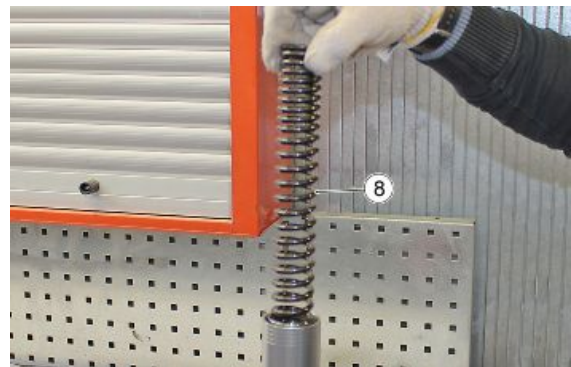
- Extract the shaft (6) and remove it.



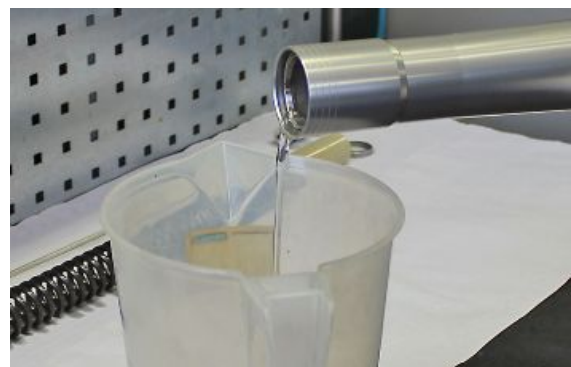
- After removing the locking plate and the device used to compress the spring, remove the upper plate (7) and the pre-loading pipe (3).



- Remove the spring (8) allowing the oil inside the stem to drip out.

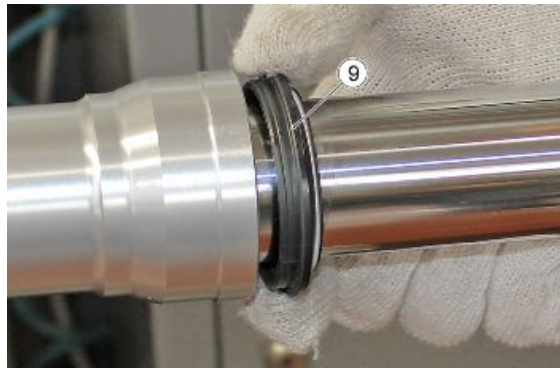


- Drain the oil into a container having sufficient capacity, extending the stem several times in order to ensure the oil is drained completely.



DO NOT DISPOSE OF OIL INTO THE ENVIRONMENT. DISPOSE OF ENGINE OIL IN A SEALED CONTAINER AND TAKE IT TO YOUR SUPPLIER OR TO THE NEAREST USED OIL COLLECTION CENTRE.

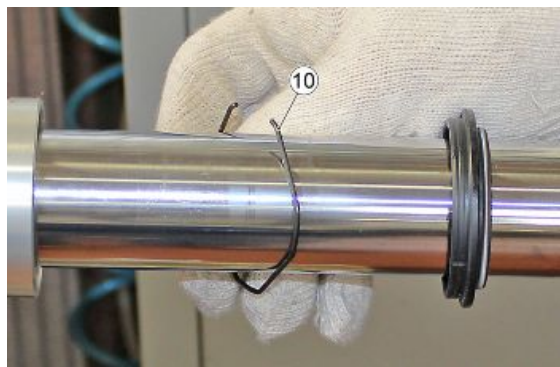
- Taking care not to damage it, secure the sleeve horizontally in a vice, using the appropriate protection devices.
- Extract the dust guard (9).



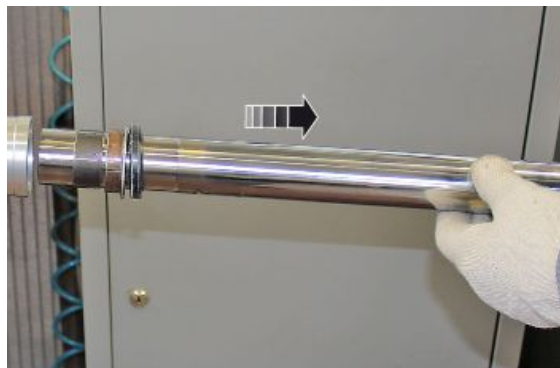
Specific tooling

AP8140149 Guard for assembly operations

- Remove the seeger ring (10) from inside the sleeve.



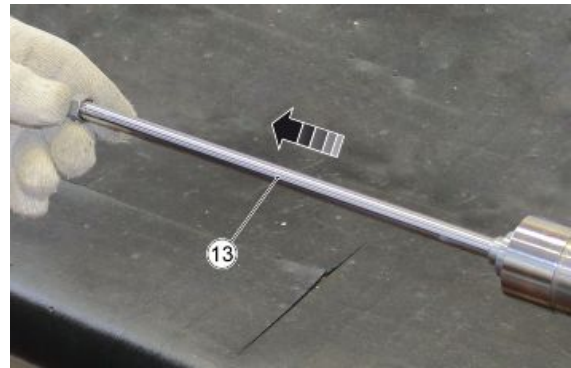
- Pull the stem repeatedly towards yourself in order to remove it from the sleeve.



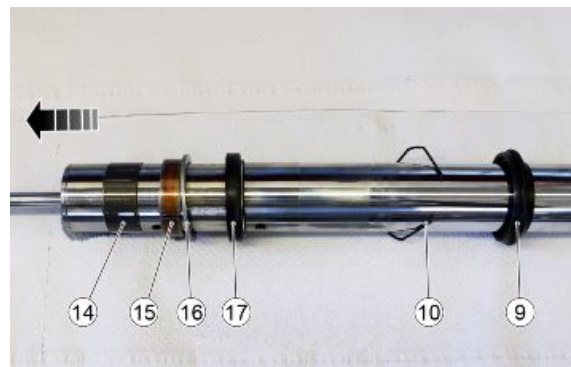
- Secure the stem in a vice and remove the plunger fastening screw (11), taking care not to lose the copper washer (12).



- Remove the complete plunger (13).



- Observing the indicated sequence, extract and remove the slider bushing (14), the guide bushing (15), the ring (16), the oil seal (17), the seeger ring (10) and the dust guard (9).



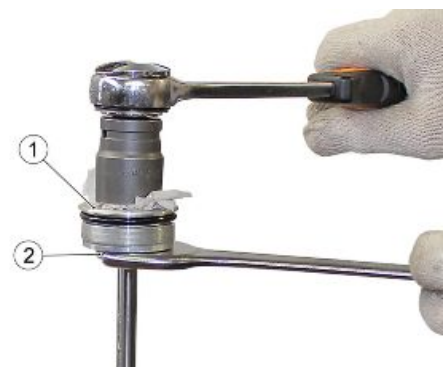
THE FOLLOWING OPERATIONS APPLY WHEN REMOVING THE RIGHT HAND STEM

- Taking care not to damage it, secure the fork vertically in a vice, using the appropriate protection devices.
- Unscrew the upper cap (1).

Specific tooling

AP8140149 Guard for assembly operations

- Ensure that the cap (1) cannot rotate, and then loosen the special nut (2).



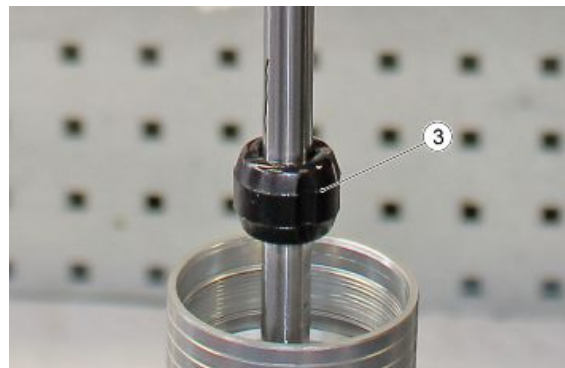
- Unscrew and remove the cap (1).



- Unscrew the special nut (2) and remove it.



- Remove the buffer (3).



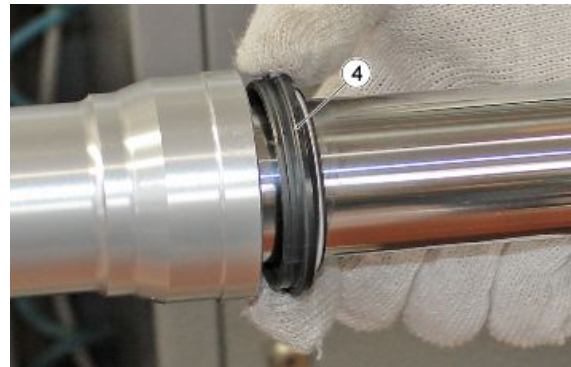
- Drain the oil into a container having sufficient capacity, extending the stem several times in order to ensure the oil is drained completely.



DO NOT DISPOSE OF OIL INTO THE ENVIRONMENT. DISPOSE OF ENGINE OIL IN A SEALED CONTAINER AND TAKE IT TO YOUR SUPPLIER OR TO THE NEAREST USED OIL COLLECTION CENTRE.



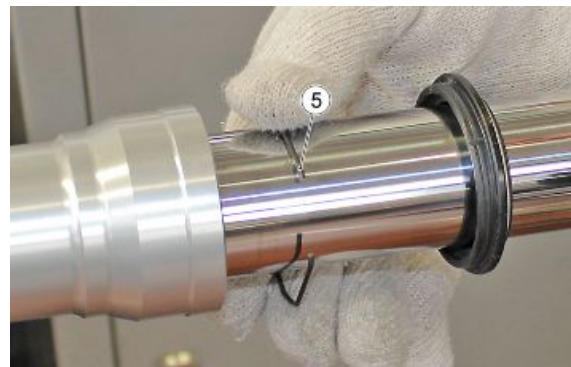
- Taking care not to damage it, secure the sleeve horizontally in a vice, using the appropriate protection devices.
- Extract the dust guard (4).



Specific tooling

AP8140149 Guard for assembly operations

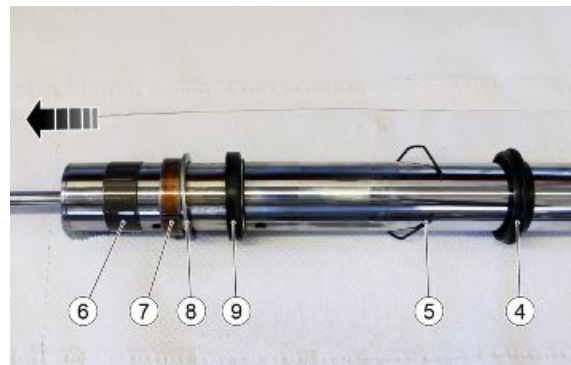
- Remove the seeger ring (5) from inside the sleeve.



- Pull the stem repeatedly towards yourself in order to remove it from the sleeve.



- Observing the indicated sequence, extract and remove the slider bushing (6), the guide bushing (7), the ring (8), the oil seal (9), the seeger ring (5) and the dust guard (4).



Checking the components

Stem

Check that the sliding surface is not scratched or scored.

Any scoring can be removed by sanding with damp sandpaper (grain 1).

If the scratches are deep, replace the stem.

Using a dial gauge, check that any bending of the stem is below the limit value.

If it is over the limit, replace the stem.

CAUTION

A BENT STEM SHOULD NEVER BE STRAIGHTENED SINCE ITS STRUCTURE WOULD BE WEAKENED MAKING THE VEHICLE DANGEROUS TO USE.

Characteristic**Bending limit:**

0.2 mm (0.00787 in)

Sleeve

Check for damage and/or cracks; if it is damaged, replace it.

Spring

Check the condition of the spring, making sure that the length is within the acceptable limits.

If not, replace the spring.

MINIMUM LENGTH OF FREE SPRING: ... mm (... in)

Check the condition of the following components:

- slider bushing;
- guide bushing;
- plunger.

If there is evidence of excessive wear or damage, replace the component concerned.

CAUTION

REMOVE ANY IMPURITIES FROM THE BUSHINGS, BEING CAREFUL NOT TO SCRATCH THEIR SURFACES.

Replace the following components with new ones:

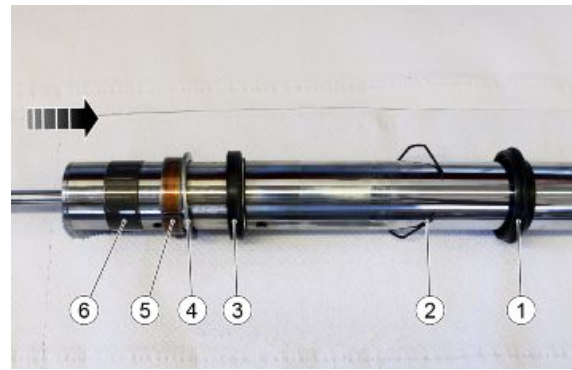
- Oil seal.
- Dust guard.
- - O-ring on the cap.

Reassembling the fork**CAUTION**

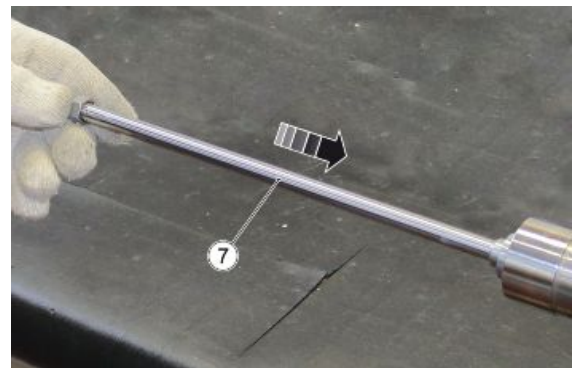
THE STEMS ARE NOT THE SAME, THEREFORE THEY REQUIRE SEPARATE MOUNTING PROCEDURES.

THE FOLLOWING OPERATIONS APPLY WHEN MOUNTING THE RIGHT HAND STEM

- Observing the indicated sequence, extract and remove the dust guard (1), the seeger ring (2), the oil seal (3), the ring (4), the guide bushing (5) and the slider bushing (6).



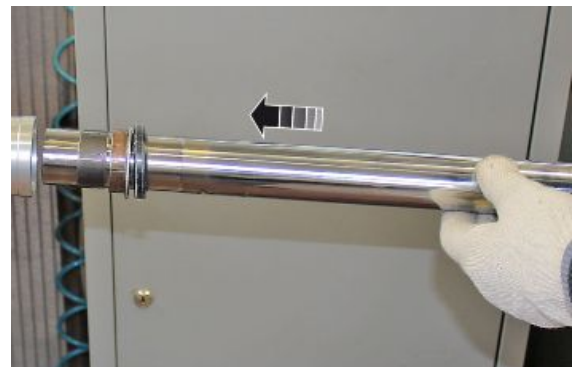
- Insert the complete plunger (7).



- Secure the stem in a vice and, after inserting the screw (8) used to fasten the plunger, complete with the copper washer (9), apply the pre-defined tightening torque.



- - Insert the stem in the sleeve.

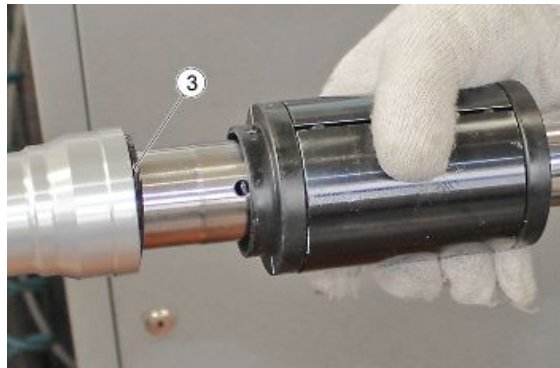


- Using a suitable tool, complete with striking hammer, insert oil seal into its housing (3).

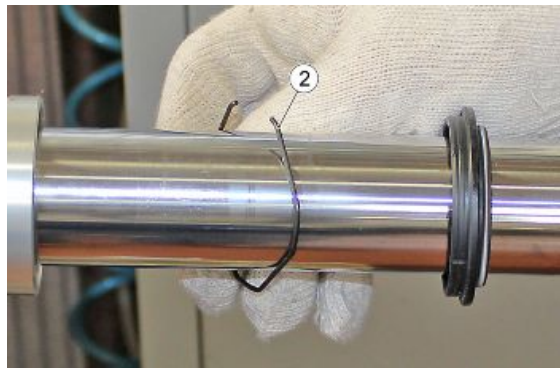
Specific tooling

AP8140189 Tool for fitting oil seal for 43 mm (1.69 in) diameter hole

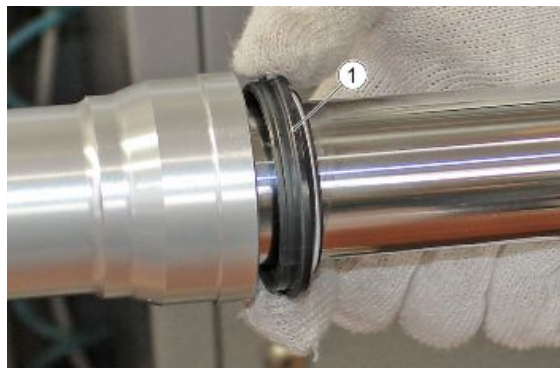
AP8140146 Weight



- Position the seeger ring (2) inside the sleeve.



- Insert the dust guard (1) into its housing correctly.



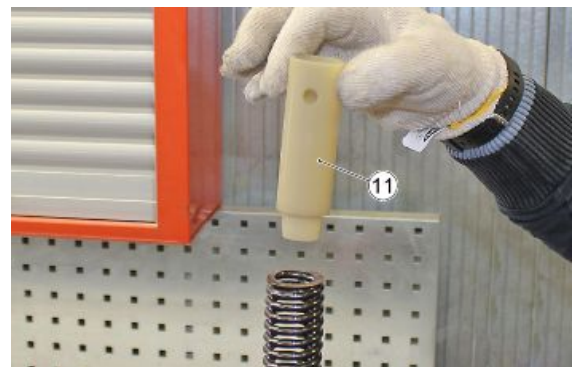
- Place the fork stem vertically on a work surface.
- Fill the stem with the quantity of oil indicated in the "Refilling oil" section.



- Insert the spring (10), making sure that it is aligned correctly. The end where the spirals are more compressed should be facing upwards



- Insert the pre-load tube (11), making sure that it is aligned correctly. The narrower part must be inserted into the spring.



- Insert the upper plate (12) on the pre-load pipe



- After positioning the device (13) on the pre-load pipe (11) and the plunger support shaft (14), with the assistance of a second operator, raise the plunger so that it is possible to insert the plate (15) under the cap locking nut.



Specific tooling

020888Y Clamp for pre-load pipe

AP8140150 Bored shaft for bleeding plunger air

AP8140148 Plunger-spacer separator plate

- Insert the shaft (16) into the plunger.



- Before positioning the cap, adjust the hydraulic regulator screw so that the internal distance is as close as possible to 13 mm (0.51 in).



- Screw the cap (17) onto the plunger as far as it will go.



- Ensure that the cap cannot rotate, and then tighten the nut.

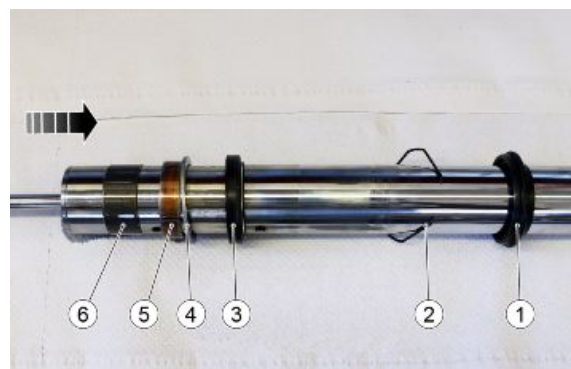


- Tighten the cap on the sleeve, applying the pre-defined torque.



THE FOLLOWING OPERATIONS APPLY WHEN MOUNTING THE LEFT HAND STEM

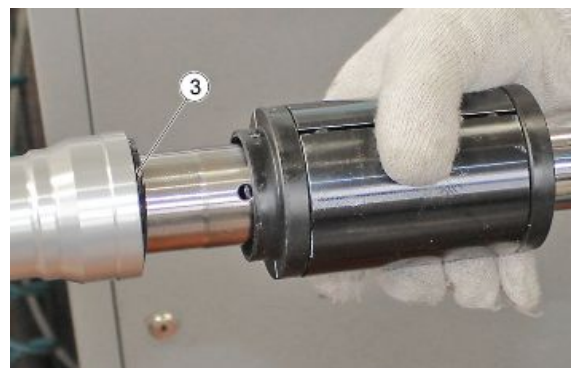
- Observing the indicated sequence, extract and remove the dust guard (1), the seeger ring (2), the oil seal (3), the ring (4), the guide bushing (5) and the slider bushing (6).



- - Insert the stem in the sleeve.



- Using a suitable tool, complete with striking hammer, insert oil seal into its housing (3).

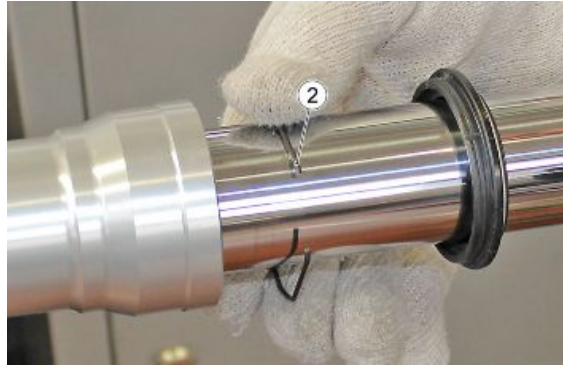


Specific tooling

AP8140189 Tool for fitting oil seal for 43 mm (1.69 in) diameter hole

AP8140146 Weight

- Position the seeger ring (2) inside the sleeve.



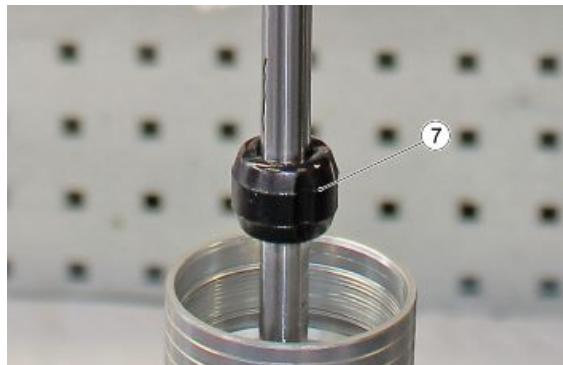
- Insert the dust guard (1) into its housing correctly.



- Place the fork stem vertically on a work surface.
- Fill the stem with the quantity of oil indicated in the "Refilling oil" section.



- Insert the buffer (7).



- Insert the special nut (8) and tighten it as far as it will go.



- Insert the cap (9) and tighten it as far as it will go.



- Ensure that the cap cannot rotate, and then tighten the nut.



- Tighten the cap on the sleeve, applying the pre-defined torque.



Filling oil

THE FOLLOWING OPERATIONS APPLY WHEN MOUNTING THE RIGHT HAND STEM

- Place the fork stem vertically on a work surface.
- Fill the STEM with the indicated quantity of oil.



WARNING

OPERATE THE PLUNGER MULTIPLE TIMES UNTIL AIR BUBBLES MAY BE SEEN ON THE SURFACE OF THE OIL.



THE FORK MUST BE PERFECTLY UPRIGHT IN ORDER TO MEASURE THE CORRECT OIL LEVEL.

Characteristic

Quantity of oil for RH STEM

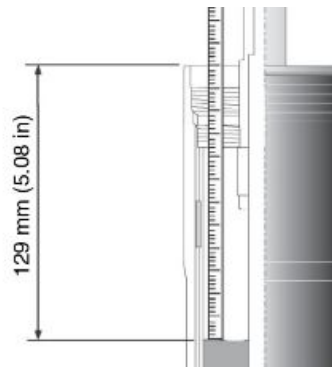
467 cm³ (28.50 cu in)

- Check the oil level from the rim of the sleeve.

Characteristic

Oil level (from sleeve rim, without the spring and with the pump all the way lowered)

129 mm (5.08 in)



THE FOLLOWING OPERATIONS APPLY WHEN MOUNTING THE LEFT HAND STEM

- Place the fork stem vertically on a work surface.
- Fill the STEM with the indicated quantity of oil.



WARNING

OPERATE THE PLUNGER MULTIPLE TIMES UNTIL AIR BUBBLES MAY BE SEEN ON THE SURFACE OF THE OIL.



THE FORK MUST BE PERFECTLY UPRIGHT IN ORDER TO MEASURE THE CORRECT OIL LEVEL.

Characteristic

Quantity of oil for LH stem

386 cm³ (23.56 cu in)

Installing the fork legs

The following procedure is described for a single fork stanchion, but is valid for both stanchions

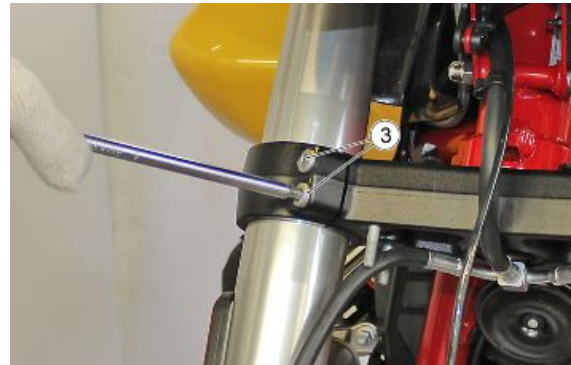
- Insert the fork stanchion (1) into the upper and lower steering yoke holes



- Insert and tighten the screw (2)



- Insert and tighten the screws (3)



Removal

- Loosen the screws (1) from both sides of the steering yoke



- Unscrew and remove the screws (2)
- Remove the U-bolt (3)



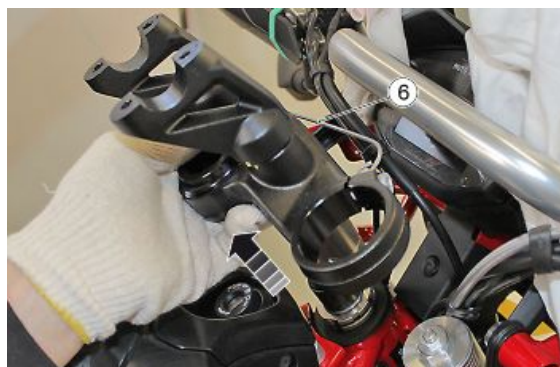
- Unscrew and remove the fastening bushing (4)



- Undo and remove the screw (5)
- Remove all the wiring from the cable grommet
- Momentarily remove the handlebar, complete with controls, from the yoke



- Remove the steering yoke (6)



Removing

- Remove the upper steering yoke
- Remove the front mudguard
- Remove the front wheel
- Undo and remove the screw (1)



- Unscrew and remove the lower ring nut (2), using the special tool



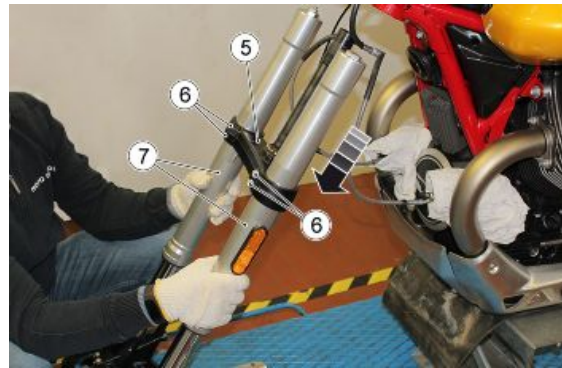
- Remove the dust cover (3)



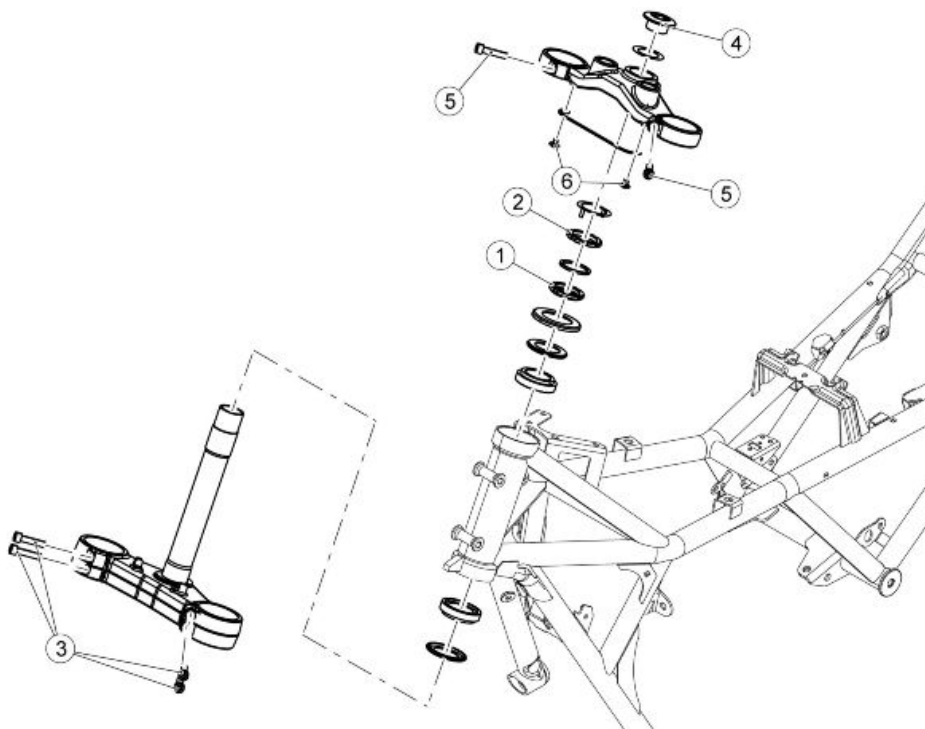
- Remove the dust seal ring (4)



- Remove the lower steering yoke (5) along with the fork stanchions
- Undo and remove the screws (6) and remove the fork stanchions (7)



Steering bearing



STERZO

Pos.	Descrizione	Tipo	Quantità	Coppia	Note
1	Ghiera fissaggio assieme piastra inferiore/perno di sterzo a canotto	-	1	-	-
2	Controghiera fissaggio assieme piastra inferiore/perno di sterzo a canotto	-	1	-	-
3	Viti fissaggio steli forcella a piastra inferiore di sterzo	M8	4	-	-
4	Bussola fissaggio piastra superiore	-	1	-	-
5	Viti fissaggio steli forcella a piastra superiore di sterzo	M8	2	-	-
6	Viti fissaggio passacavo a piastra superiore di sterzo	M6	2	10 Nm (7.38 lbf ft)	-

Adjusting play

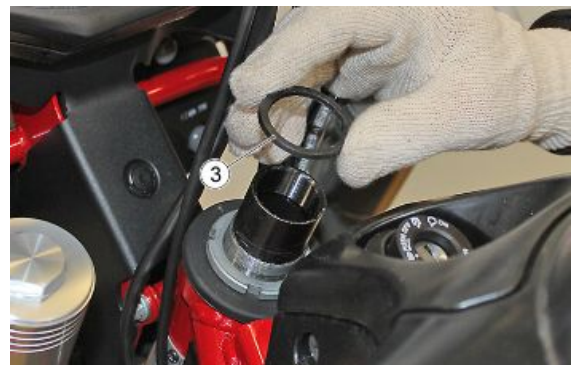
- Remove the upper steering yoke
- Remove the safety washer (1)



- Unscrew and remove the upper ring nut (2), using the special tool



- Remove the rubber gasket (3)



- Adjust by tightening the lower ring nut to the prescribed torque
- With the front wheel lifted off the ground, turn the steering all the way right and left three or four times
- Check the tightening torque of the lower ring nut



NOTE

HANDLEBAR TURNING RESISTANCE SHOULD BE 250 ± 150 g IN BOTH DIRECTIONS

- Refit the rubber gasket (3)
- Mount the upper ring nut (2), manually tightening it more than 90° so that the necks of both ring nuts correspond with one another
- Correctly reposition the safety washer (1)



Disassembling

- Remove the lower steering yoke

UPPER STEERING BEARING

- Remove the upper seat (1) of the upper steering bearing



- Remove the upper steering bearing (2)



- Using a generic bearing puller, remove the lower seat of the steering bearing as illustrated in the figure



LOWER STEERING BEARING

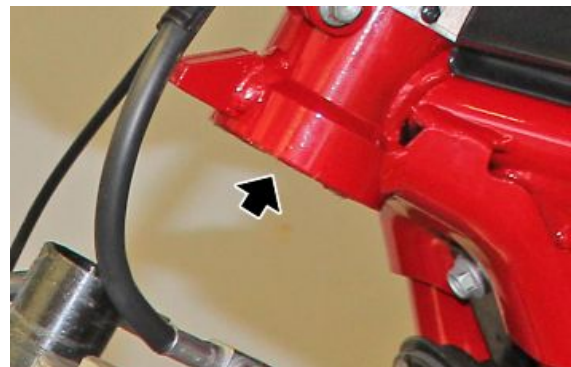
- Remove the lower steering bearing (4)



-
- Remove the lower seat (5) of the lower steering bearing



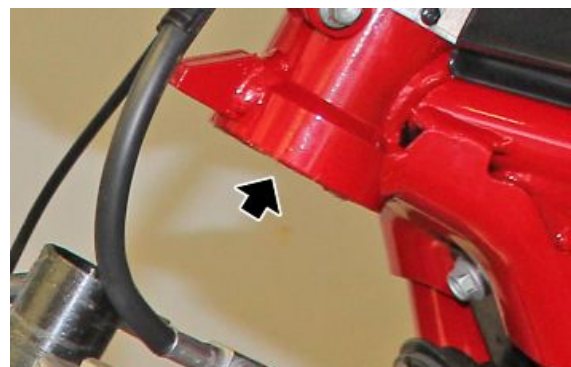
-
- Using a generic bearing puller, remove the upper seat of the lower steering bearing as indicated in the figure



Assembling

LOWER STEERING BEARING

- Using the appropriate punch, insert the upper seat of the lower steering bearing in the point indicated in the figure



- Insert the lower seat (1) of the lower steering bearing

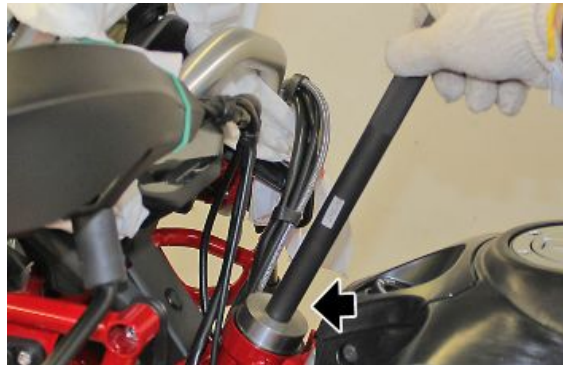


- Insert the lower steering bearing (2)

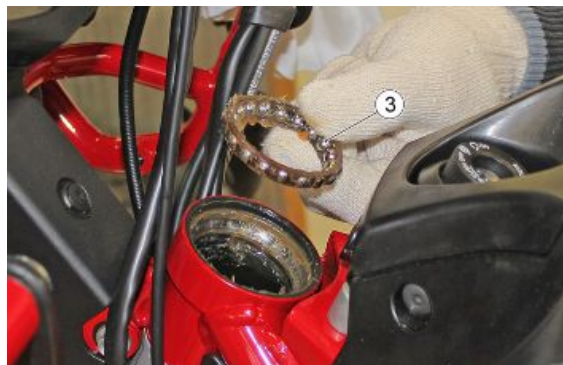


UPPER STEERING BEARING

- Using the appropriate punch, insert the lower seat of the upper steering bearing as illustrated in the figure



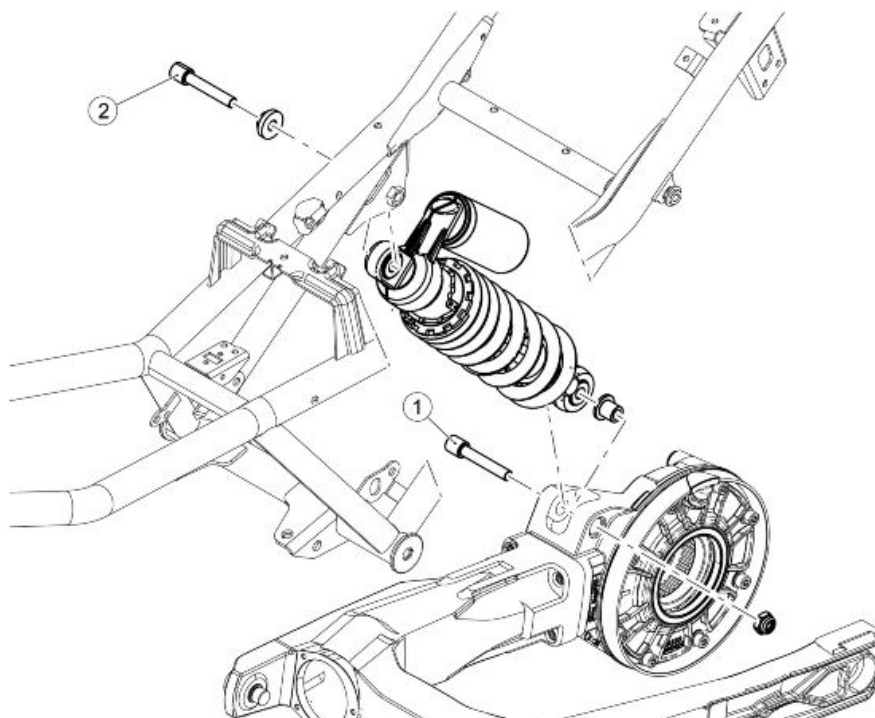
- Insert the upper steering bearing (3)



- Insert the upper seat (4) of the upper steering bearing



Shock absorbers

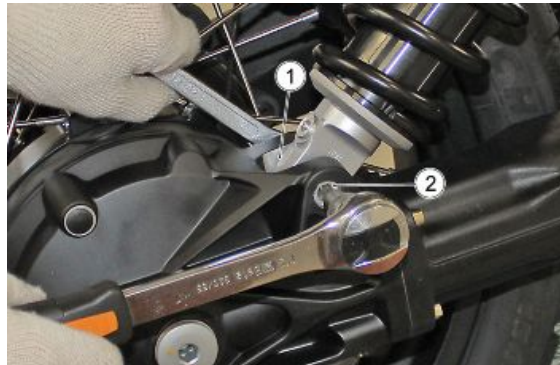


AMMORTIZZATORE

Pos.	Descrizione	Tipo	Quantità	Coppia	Note
1	Vite fissaggio ammortizzatore posteriore su scatola trasmissione	M10	1	50 Nm (36.88 lbf ft)	-
2	Vite fissaggio ammortizzatore posteriore su telaio	M10	1	50 Nm (36.88 lbf ft)	-

Removing

- Blocking the nut (1)
- Undo and remove the screw (2)



- Undo and remove the screw (3)
- Retrieve the bushing (4)



- Remove the shock absorber (5)



INDEX OF TOPICS

CHASSIS

CHAS

Front wheel

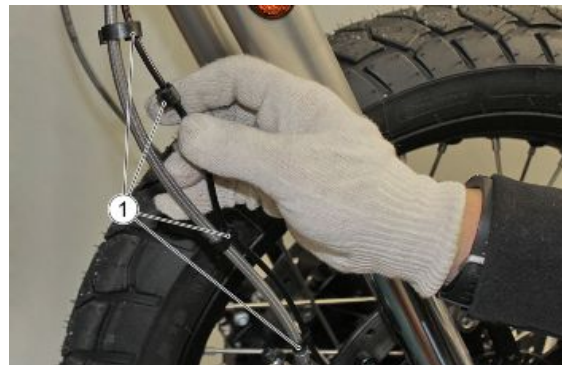


RUOTA ANTERIORE

Pos.	Descrizione	Tipo	Quantità	Coppia	Note
1	Dado fissaggio perno ruota anteriore	-	1	80 Nm (59.00 lbf ft)	-

Removal

- Place a support under the vehicle and secure it using belts so that the wheel can move freely and the vehicle does not fall.
- Remove the ABS sensor cable from the cable glands (1)



- Unscrew and remove the screws (2)



- Remove the ABS sensor (3) from the front right fork



- Unscrew and remove the screws (4)
- Remove the front left brake calliper (5) from the brake disc



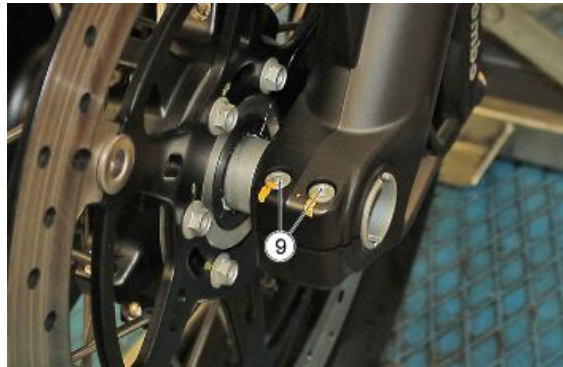
- Unscrew and remove the screws (6)
- Remove the front right brake calliper (7) from the brake disc



- Loosen the screws (8)



- Loosen the screws (9)



- Unscrew the nut (10) and remove it.



- Retrieve the washer (11)



- Remove the wheel axle (12)



- Remove the front wheel (13)



- Retrieve the washer (14)



REMOVING THE FRONT BRAKE DISCS

The following procedure is described for a single brake disc, but is valid for both front brake discs.

- Remove the front wheel
- Unscrew and remove the screws (1)



- Remove the phonic wheel (2)



- Remove the front brake disc (3)



FRONT WHEEL BEARING REMOVAL

- Remove the front wheel
- Remove the dust cover (1)



- Using a generic bearing puller, remove the bearing as illustrated in the figure
- Repeat the entire operation from the opposite side of the wheel to remove the second bearing



Installing

- Insert the spacer (1)



- Place the front wheel (2) between the fork stanchions



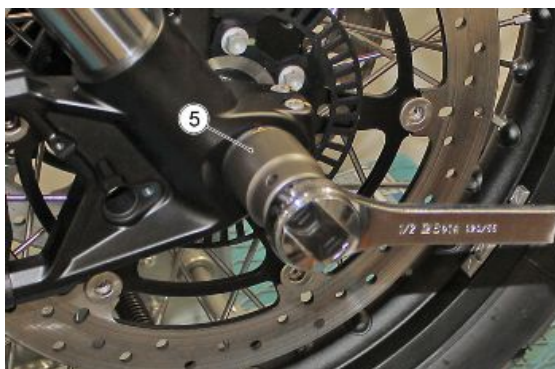
- Insert the wheel pin (3)



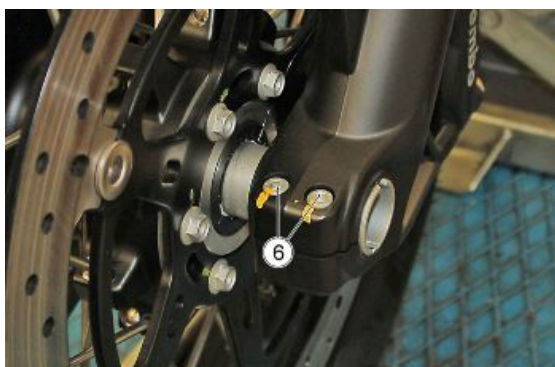
- Insert the washer (4)



- Insert and tighten the nut (5)



- Tighten the screws (6)



- Tighten the screws (7)



- Correctly place the right front brake calliper (8)
- Insert and tighten the screws (9)



- Correctly place the right front brake calliper (10)
- Insert and tighten the screws (11)



- Position the ABS sensor (12) on the calliper mounting bracket



- Insert and tighten the screws (13)



- Insert the ABS sensor cable in the cable glands (14)



FRONT BRAKE DISCS INSTALLATION

The following procedure is described for a single brake disc, but is valid for both front brake discs.

- Place the front brake disc (1)



- Place the phonic wheel (2)



- Insert and tighten the screws (3)



FRONT WHEEL BEARINGS INSTALLATION

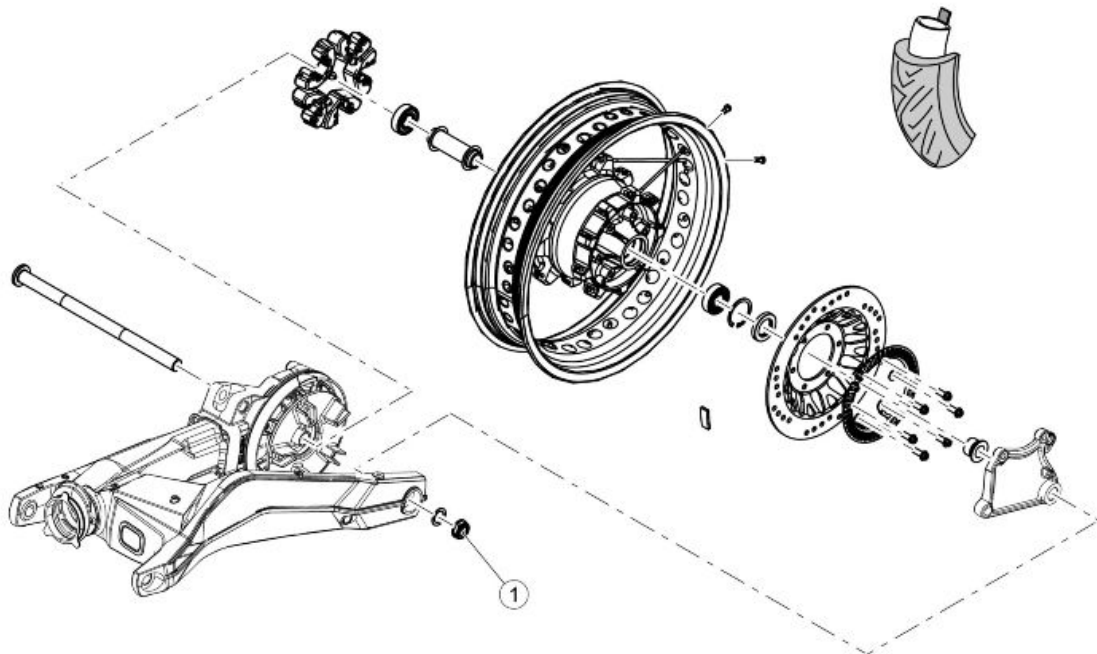
- Using an appropriate punch, install the wheel bearing as illustrated in the figure



- Insert the dust cover (1)
- Rotate the wheel and repeat the entire operation from the opposite side of the wheel to install the second bearing



Rear wheel



RUOTA POSTERIORE

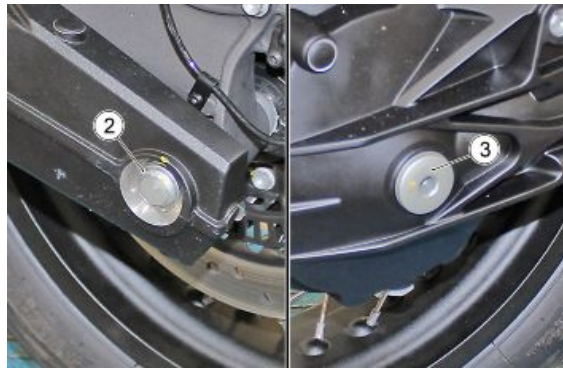
Pos.	Descrizione	Tipo	Quantità	Coppia	Note
1	Dado fissaggio perno ruota posteriore	-	1	100 Nm (73.76 lbf ft)	-

Rimozione

- Undo and remove the screw (1)



- Holding the pin (3) in place, unscrew and remove the nut (2)



- Retrieve the washer (4)



- Remove the pin (3)



- Remove the brake calliper support plate (5) from the brake disc, complete with rear brake calliper



- Remove the rear wheel (6)

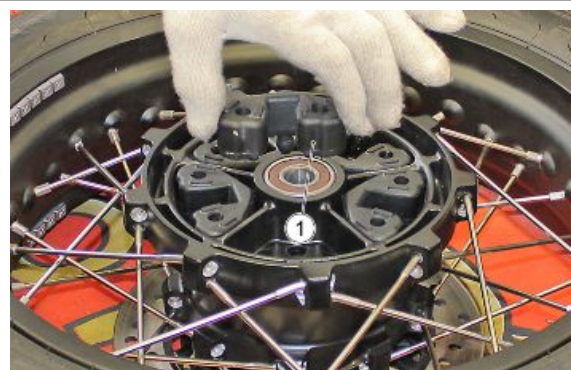


- Retrieve the bushing (7)



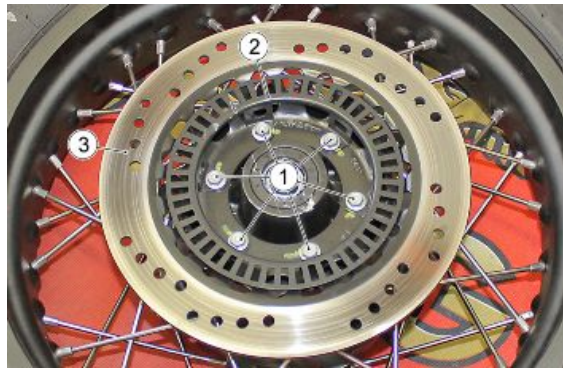
FLEXIBLE COUPLING REMOVAL

- Remove the rear wheel
- Remove the flexible couplings (1)



REMOVING THE REAR BRAKE DISC

- Remove the rear wheel
- Unscrew and remove the screws (1)
- Remove the phonic wheel (2)
- Remove the brake disc (3)

**Installing**

- Place the spacer (1) on the rear wheel



- Place the rear wheel (2) in the swing-arm



- Correctly place the rear brake calliper (3), complete with support bracket



- Insert the wheel pin (4)



- Insert the washer (5)



- Holding the pin (6) in place, tighten the nut (7)

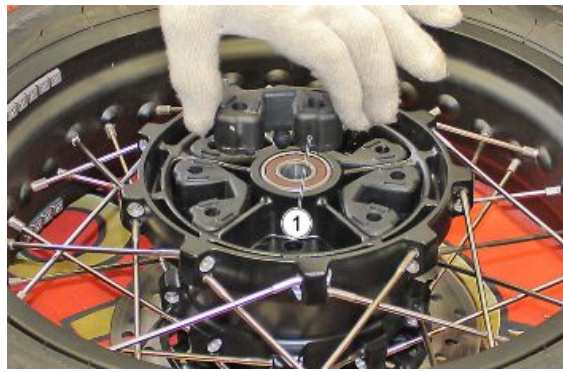


- Insert and tighten the screw (8)

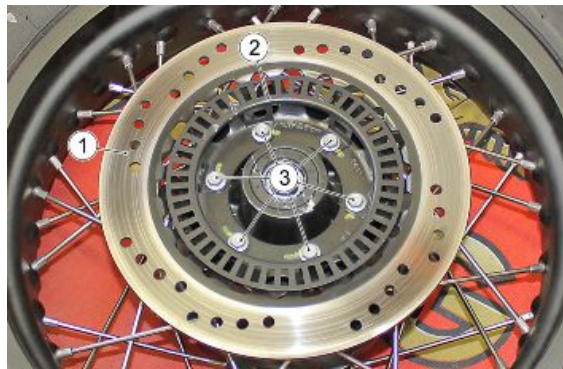
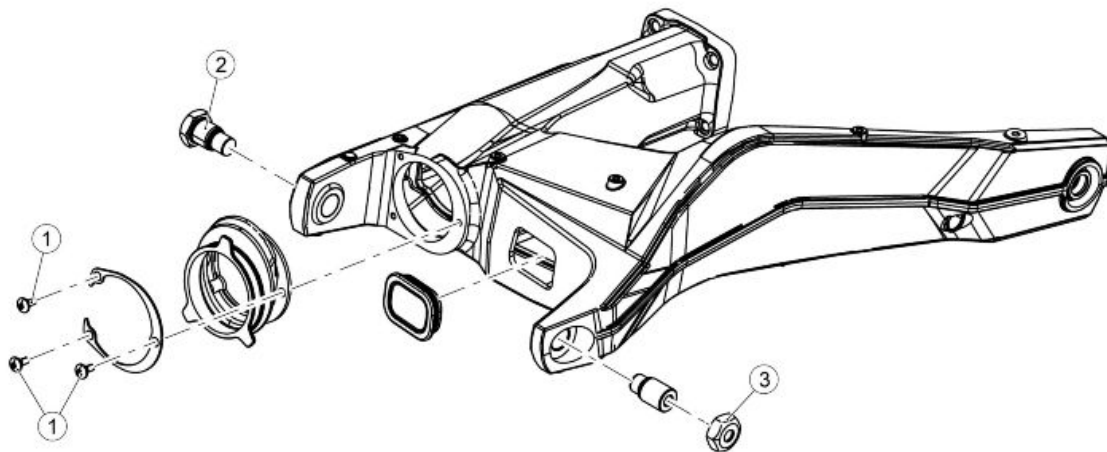


FLEXIBLE COUPLINGS INSTALLATION

- Remove the rear wheel
- Insert the flexible couplings (1) in the specific lodging

**REAR BRAKE DISC INSTALLATION**

- Remove the rear wheel
- Place the brake disc (1)
- Place the phonic wheel (2)
- Insert and tighten the screws (3)

**Swinging arm****FORCELLONE**

Pos.	Descrizione	Tipo	Quantità	Coppia	Note
1	Vite fissaggio soffietto a forcellone	M5	3	6 Nm (4.43 lbf ft)	-

Pos.	Descrizione	Tipo	Quantità	Coppia	Note
2	Dado fissaggio perno forcellone	-	1	50 Nm (36.88 lbf ft)	-
3	Perno fissaggio forcellone	-	1	50 Nm (36.88 lbf ft)	-
-	Vite fissaggio passatubo freno posteriore a forcellone	M5	2	6 Nm (4.43 lbf ft)	-

Removing

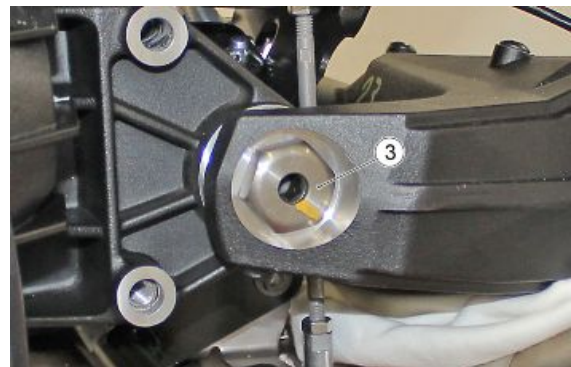
- Removing the clamp (1)



- Unscrew the pin (2) and remove it.



- Unscrew the nut (3) and remove it



- Unscrew the pin (4) and remove it.



- Remove the swingarm (5)



Removing

- Remove the footrest plates
- Remove the rear wheel
- Remove the swingarm
- Strike a few times with a mallet to remove the cardan shaft (1)

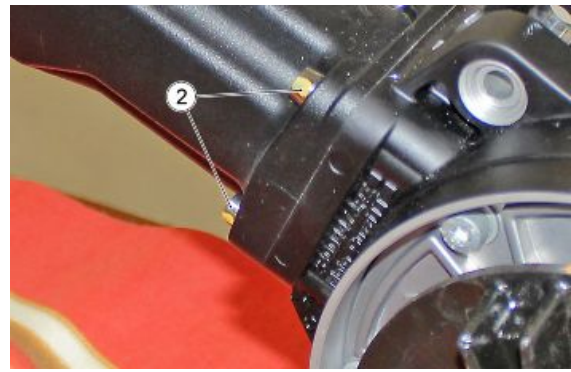


Removing

- Unscrew and remove the screws (1)



- Unscrew and remove the screws (2)



- Remove the bevel gear (3)



Removal

- Undo the gearbox cover fixing screws



- Using the suitable special tool, heat the perimeter of the cover



Specific tooling

020151Y Air heater

- If available, use the threaded stud bolts as a guide to remove the cover. Turn the complete box and tapping it on a flat surface, remove the cover.



- Slide off the complete cover from the crown.



- Remove the crown axle thickness.



- Remove the inside spacer.



- Collect the washer.



- Remove the needle bearing.



- Using a suitable tool, disengage the radial snap ring.



- Remove the radial snap ring.



- Using the special tool, heat the seat of the outer track of the needle bearing.

**Specific tooling****020151Y Air heater**

- Insert the special tool under the washer and screw the cursor.

**Specific tooling****001467Y036 Bearing internal cup extractor**

- Insert a suitable bushing on the proper tool and screw the nut while holding the extractor.



- Remove the outer track of the needle bearing.



- Remove the washer.



- Remove the sealing ring. When reassembling use a new ring.



- Using a suitable tool, remove the radial snap ring.



- Using special tool, unscrew the ring nut. At the end of the thread, screw until it stops in such a way as to create the space between the same ring nut and the shoulder washer.

Specific tooling

020999Y Crown counter- lock ring wrench



- Insert the special tool under the shoulder washer and screw the cursor.

Specific tooling

19.90.70.00 Extractor for internal ring on drilled bolt



- Remove the inner track of the needle bearing.



- Remove the shoulder washer.



- Remove the ring nut.



- Remove the crown gear.



- Remove the cover from the gearbox of the splash guard hub.



- Remove the O-ring. When reassembling use a new O-ring.



- Rotate the cover and remove the seal ring. When reassembling use a new seal ring.



- Using special tool, unscrew the pinion bearings case.

Specific tooling**020998Y Pinion case wrench**

- Remove the complete pinion from its seat.



- Using the special tool, lock in the vice, unscrew fastening nut and lock nut of the pinion case bearing.

Specific tooling**021000Y Bevel gear pair support**

- Remove the spacer closing bearings.



- Remove the sealing ring.

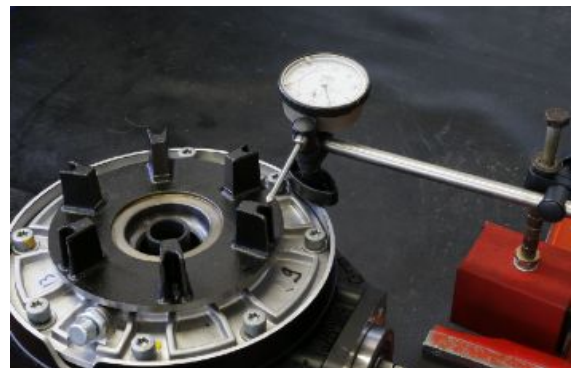


- Remove the O-ring.



Checking

- After assembly of the box, it is necessary to check the play between the pinion and the crown. Clamp in a vice and install a dial gauge by means of a suitable support. The dial gauge tester must be placed the outer end of a tooth positioned at 90°.



Characteristic

Maximum clearance allowed

0.10-0.15 mm (0.004-0.006 in)

Assembling

- Insert the new O-ring in the pinion unit, or use the one removed during the dismantling phase if it is intact and undamaged



- Insert the seal ring until it stops



- Insert the spacer closing bearings paying attention that the manufactured part is facing the O-ring so as not to damage it



- Using the special tool, lock in the vice, screw the fastening nut and lock nut of the pinion case bearing to torque.



Specific tooling

021000Y Bevel gear pair support

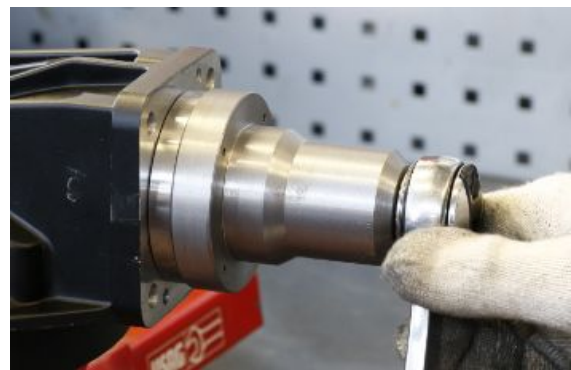
- Insert the complete pinion in its seat.



- Using special tool, screw the pinion bearings case.

Specific tooling

020998Y Pinion case wrench



- Using the special tool, insert a new seal ring in the cover.
- On the opposite side of the cover, insert a new O-ring.
- Replace the sprocket hub cover.
- Replace the crown and the fastening ring nut.

Specific tooling

021005Y Punch seals on the bevel gear cover

- Screw the ring nut on the crown to the prescribed torque.



- Insert the shoulder washer. Using the special tool, insert the inner track of the needle bearing. Insert the radial snap ring.

Specific tooling

GU19927900 Punch for pressing bearing inner ring onto drilled pin



- Reposition the crown axle thickness.

NOTE

THE THICKNESS HAS A UNIQUE POSITION IN THE BOX. PAY ATTENTION TO THE CORRECT POSITION BY CHECKING THE CORRESPONDENCE OF THE HOLES WITH THE FASTENING SCREWS.



- Replace the complete cover of the hub in the box.



- Screw to torque the cover fixing screws.



Installing

- Insert the bevel gear (1) on the swing-arm



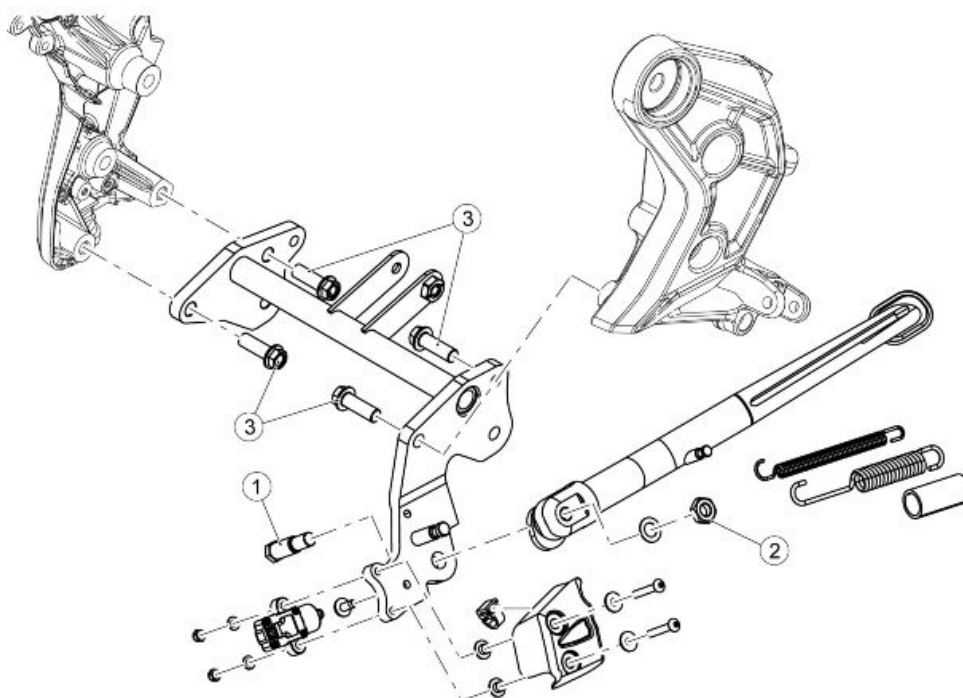
- Insert and tighten the fastening screws (2) to the prescribed torque



- Insert and tighten the fastening screws (3) to the prescribed torque



Stand



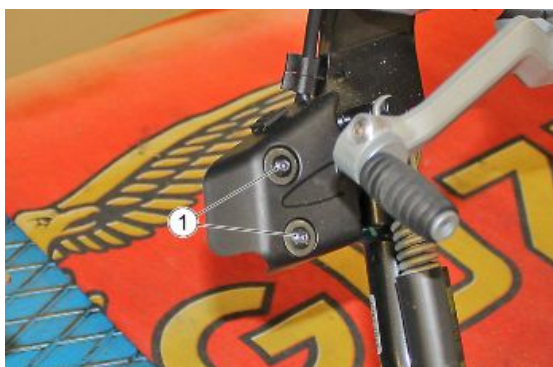
CAVALLETTO

Pos.	Descrizione	Tipo	Quantità	Coppia	Note
1	Perno fissaggio cavalletto laterale	-	1	10 Nm (7.38 lbf ft)	-
2	Dado fissaggio cavalletto laterale a supporto cavalletti	M10	1	30 Nm (22.13 lbf ft)	Loctite 243
3	Viti fissaggio supporto cavalletti a telaio	M10	4	50 Nm (36.88 lbf ft)	-

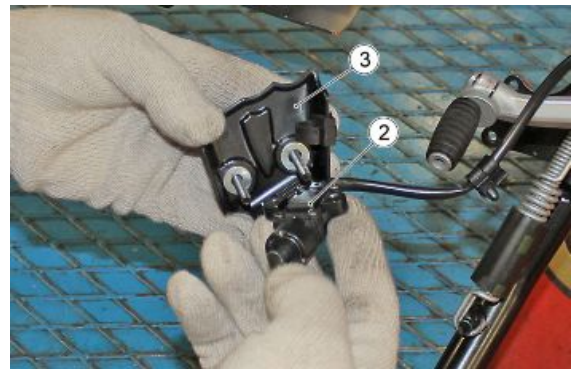
Side stand

REMOVAL

- Unscrew and remove the screws (1)



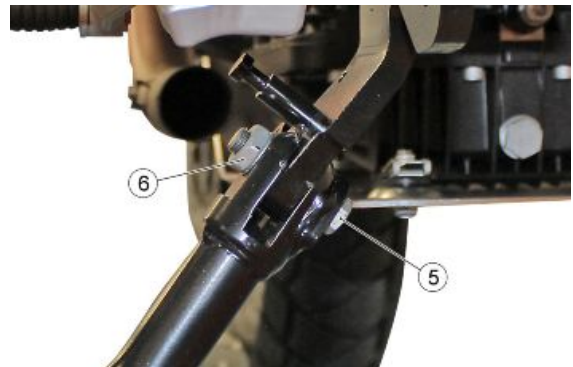
- Remove the sensor (2) and the cover (3) from the stand support



- Remove the spring (4)



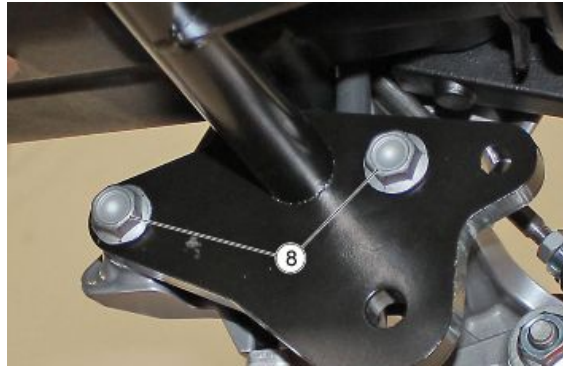
- Holding the pin (5) in place, unscrew and remove the nut (6)



- Remove the side stand (7).



- Unscrew and remove the screws (8)



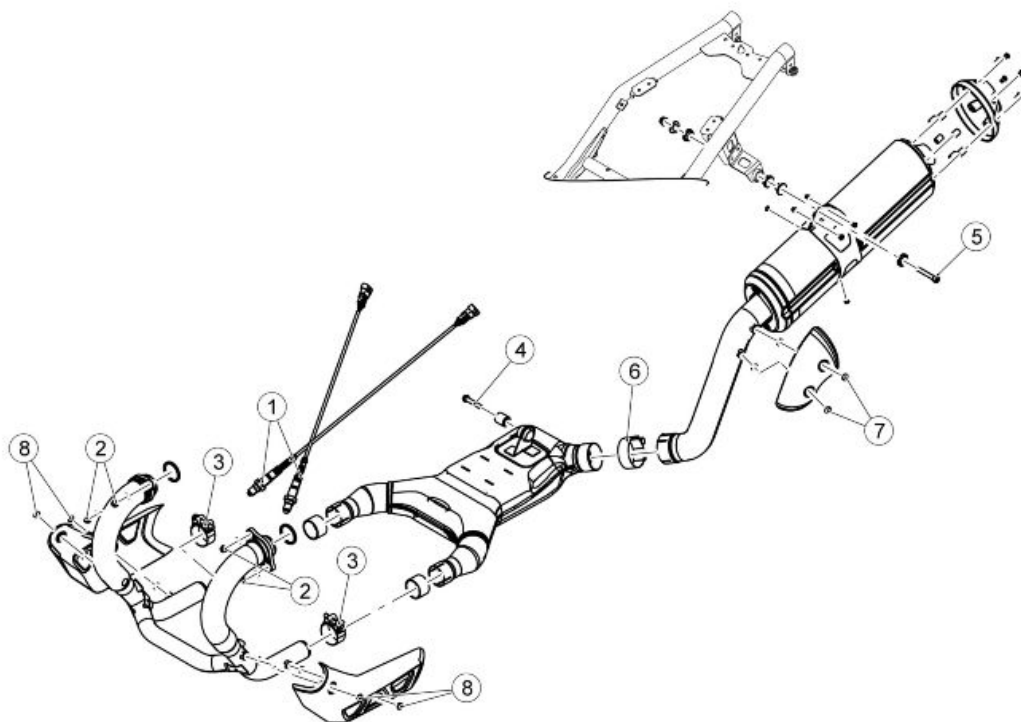
- Unscrew and remove the screws (9)



- Remove the stand support (10)



Exhaust

**MARMITTA**

Pos.	Descrizione	Tipo	Quantità	Coppia	Note
1	Fissaggio sonda lambda	-	2	38 Nm (28.03 lbf ft)	-
2	Dado fissaggio collettori di scarico a teste motore	M8	4	25 Nm (18.44 lbf ft)	-
3	Fascetta fissaggio compensatore a collettori di scarico	-	2	25 Nm (18.44 lbf ft)	-
4	Vite fissaggio compensatore a supporto cavalletto	M8	1	25 Nm (18.44 lbf ft)	-
5	Vite fissaggio silenziatore a telaio	M8	1	25 Nm (18.44 lbf ft)	-
6	Fascetta fissaggio silenziatore a compensatore	-	1	25 Nm (18.44 lbf ft)	-
7	Viti fissaggio paracalore silenziatore a silenziatore	M6	2	10 Nm (7.38 lbf ft)	-
8	Vite fissaggio paracalori a collettori	M6	4	10 Nm (7.38 lbf ft)	-

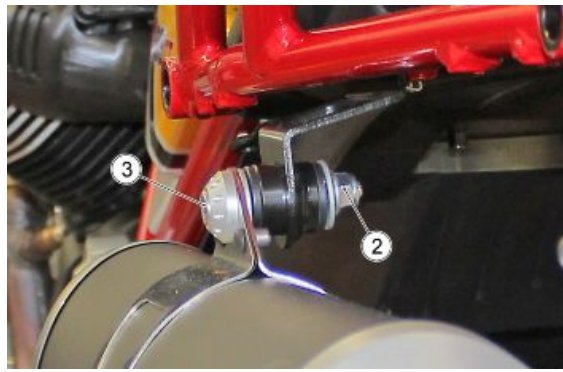
Removing the tail pipe

REMOVAL

- Loosen the clamp (1)



- Block the nut (2) so that it cannot rotate and remove the screw (3)

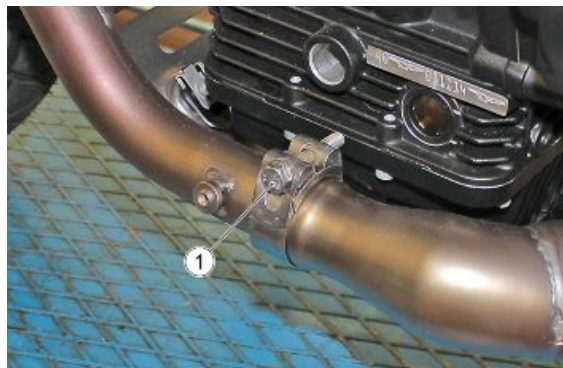


- Remove the rear silencer (4)

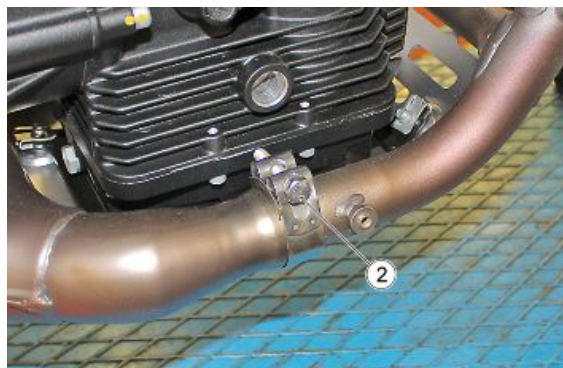


Removing the manifold - tail pipe

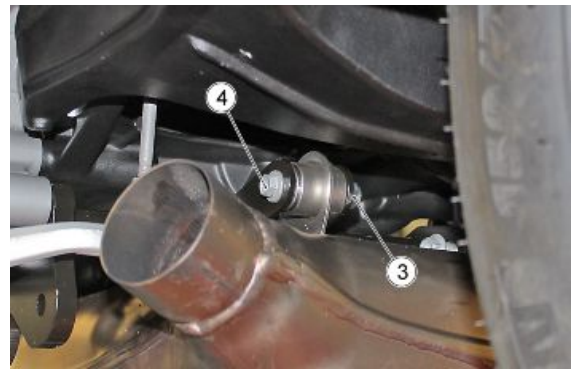
- Remove the terminal
- Loosen the clamp (1)



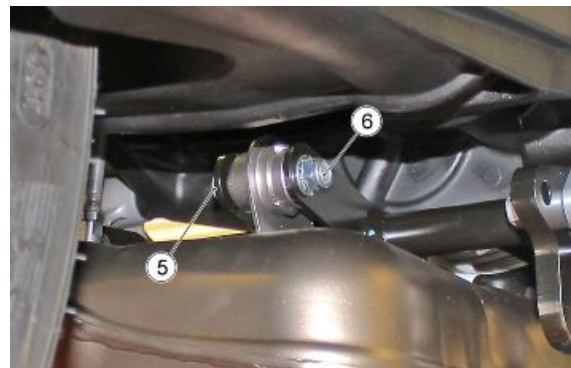
- Loosen the clamp (2)



- Block the nut (3) so that it cannot rotate and remove the screw (4)



- Block the nut (6) so that it cannot rotate and remove the screw (5)

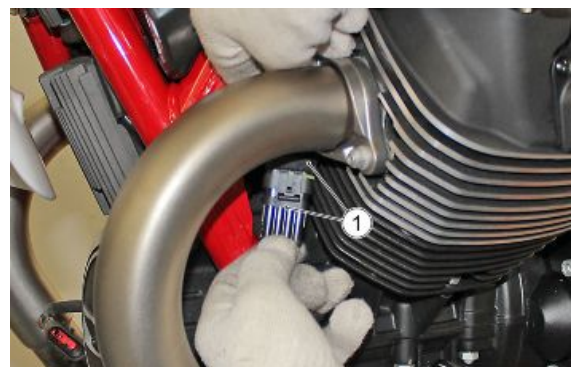


- Remove the central manifold (7)



Removing the exhaust manifold

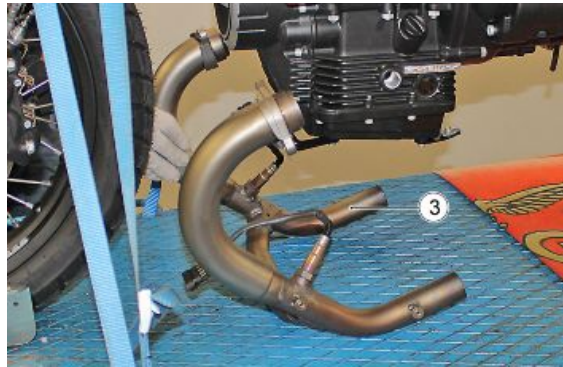
- Disconnect the lambda probe connectors (1) from both sides of the vehicle



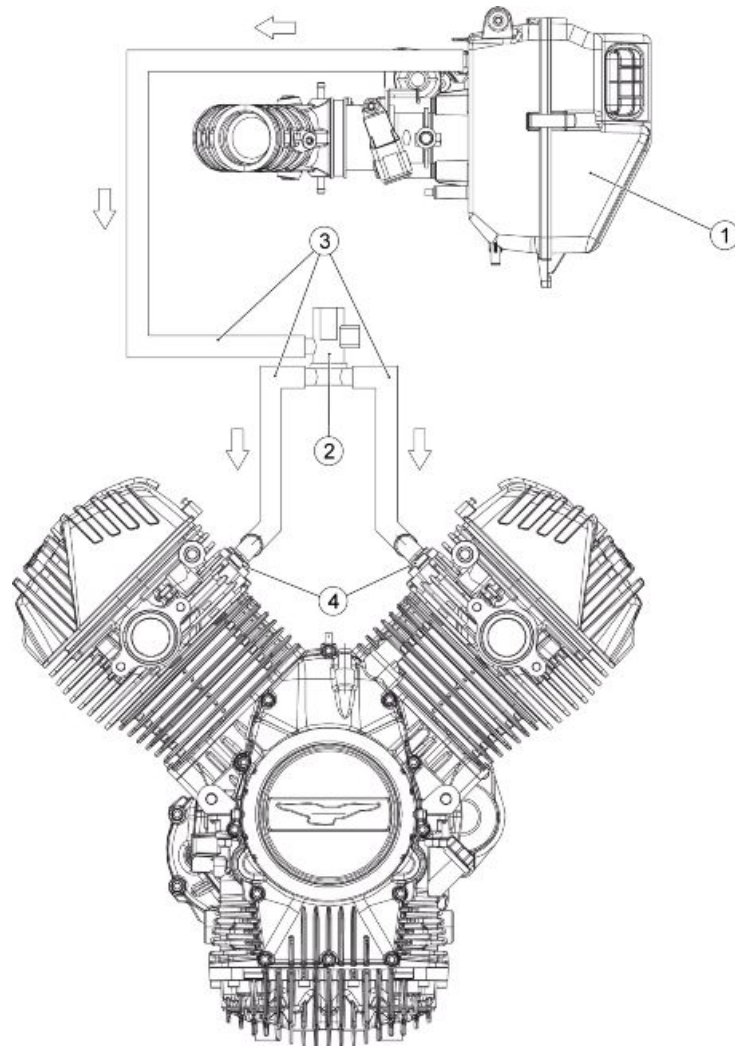
- Unscrew and remove the nuts (2) from both sides of the vehicle



- Remove the exhaust manifold (3)



Aria secondaria

**key:**

1. Air filter casing
 2. Secondary air valve
 3. Secondary air system pipe
 4. Secondary air system inlets on the engine
- Two auxiliary air inlets have been included in the cylinder head which, in combination with the injection system with oxygen sensor and three-way catalytic converter, ensure compliance with severe new Euro 4 emissions regulations

-
- Undo the screws fastening the reed valve cover.



-
- Remove the reed valve cover



-
- Remove the reed valve.



-
- Remove the flame trap.



- A valve controlled by the engine ECU is installed under the tank, which allows air to flow towards the cylinders via two flexible hoses.



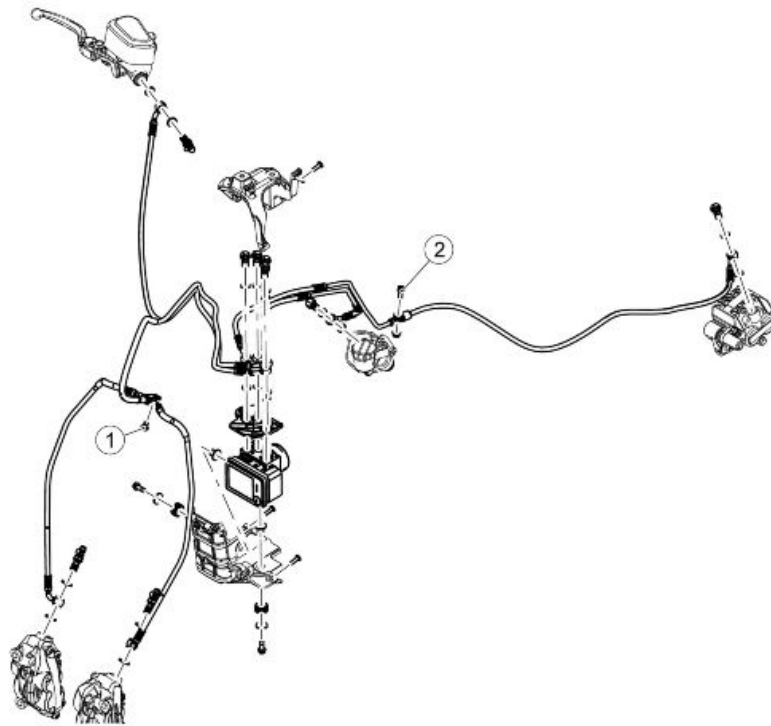
- This valve is connected directly to the filter box via a flexible hose.



INDEX OF TOPICS

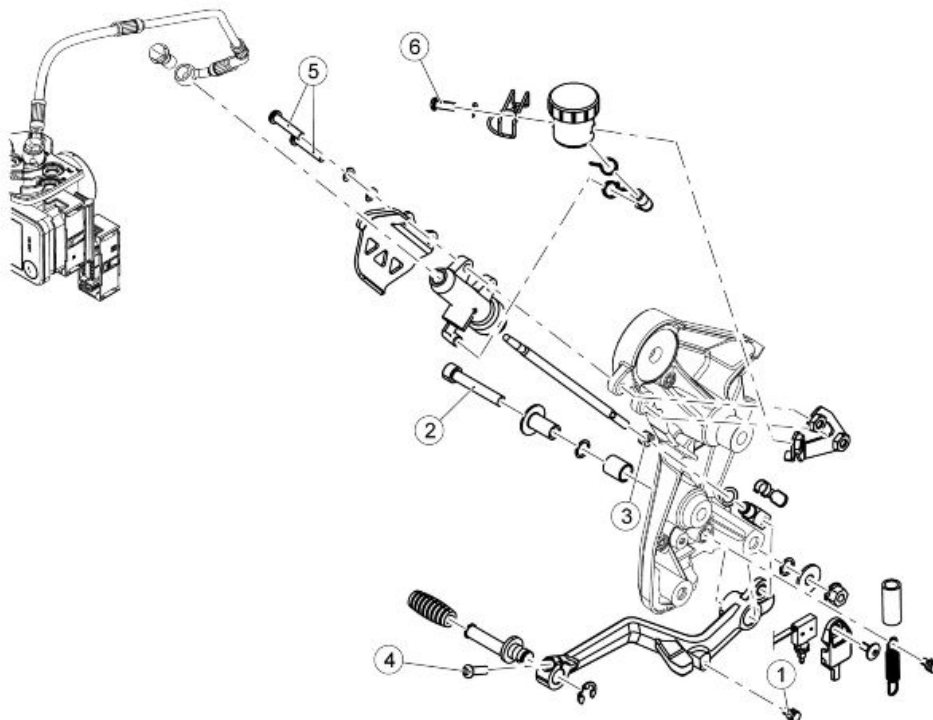
BRAKING SYSTEM

BRAK SYS



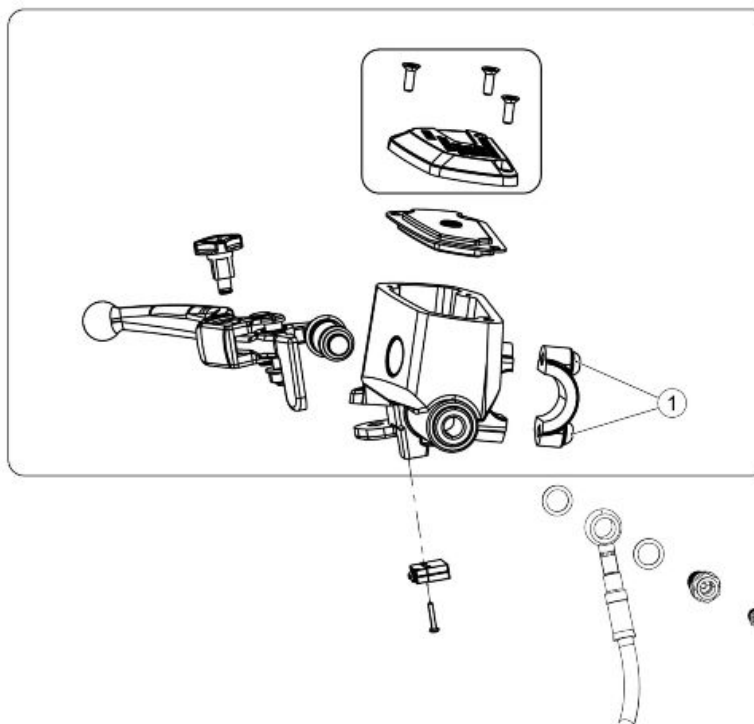
IMPIANTO FRENANTE ABS

Pos.	Descrizione	Tipo	Quantità	Coppia	Note
1	Vite fissaggio tubi freno a piastra inferiore di sterzo	M6	1	10 Nm (7.38 lbf ft)	-
2	Vite fissaggio posteriore tubi freno a telaio	M6	1	10 Nm (7.38 lbf ft)	-

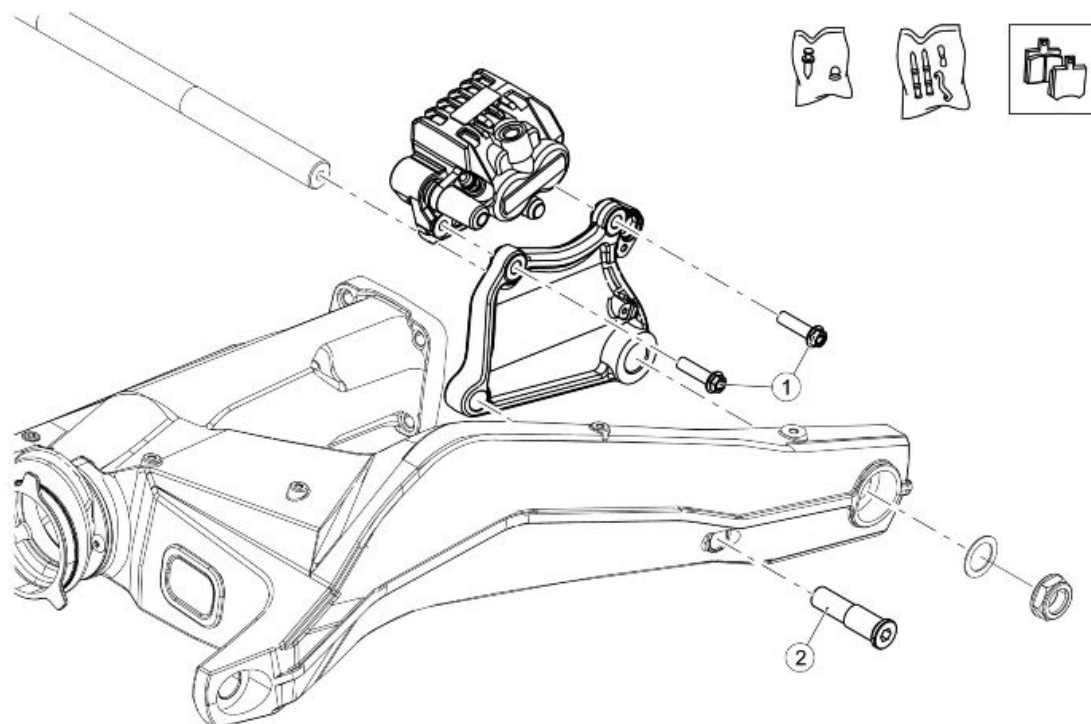


POMPA FRENO POSTERIORE

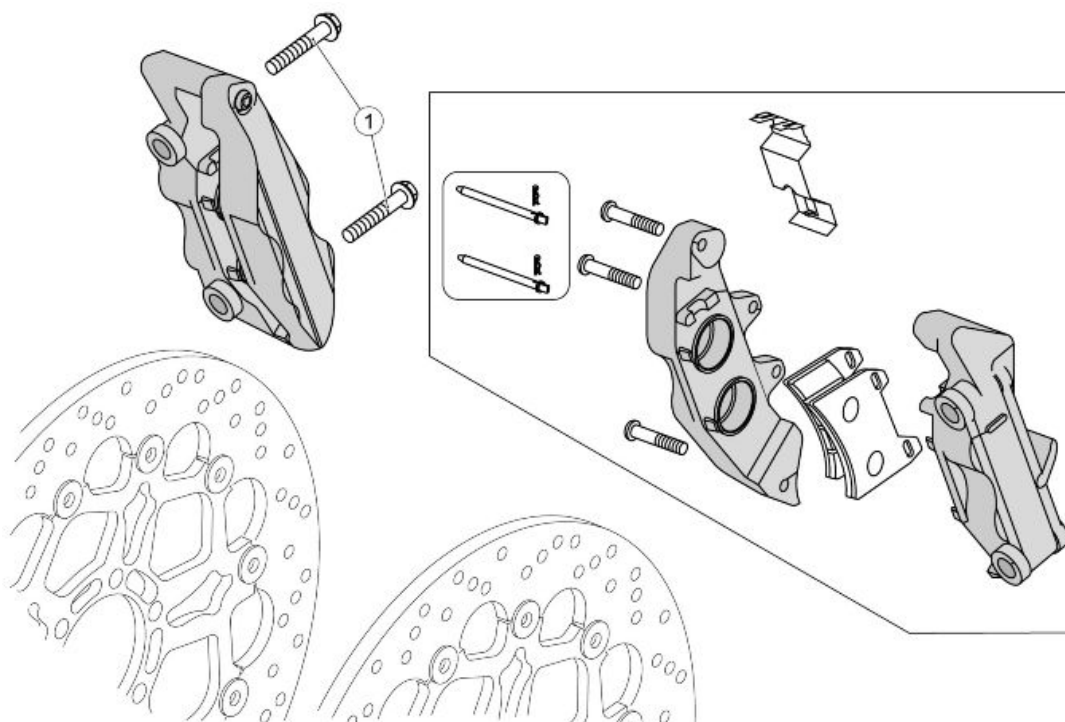
Pos.	Descrizione	Tipo	Quantità	Coppia	Note
1	Perno fissaggio aggancio molla leva freno posteriore a piastra telaio	-	1	6 Nm (4.43 lbf ft)	-
2	Vite fissaggio leva freno posteriore a piastra telaio	M8	1	25 Nm (18.44 lbf ft)	-
3	Dado fissaggio asta pompa freno posteriore a leva	M6	1	-	-
4	Vite fissaggio piolo	M6	1	10 Nm (7.38 lbf ft)	-
5	Viti fissaggio pompa freno posteriore e supporto serbatoio olio a piastra telaio	M6	2	10 Nm (7.38 lbf ft)	-
6	Vite fissaggio serbatoio olio e fermatappo a staffa supporto serbatoio olio	M6	1	6 Nm (4.43 lbf ft)	-
-	Perno fissaggio aggancio molla leva freno a leva freno posteriore completa	-	1	6 Nm (4.43 lbf ft)	-

**POMPA FRENO ANTERIORE**

Pos.	Descrizione	Tipo	Quantità	Coppia	Note
1	Viti fissaggio morsetto pompa freno anteriore a manubrio	M6	2	10 Nm (7.38 lbf ft)	Viti pre-montate sulla pompa

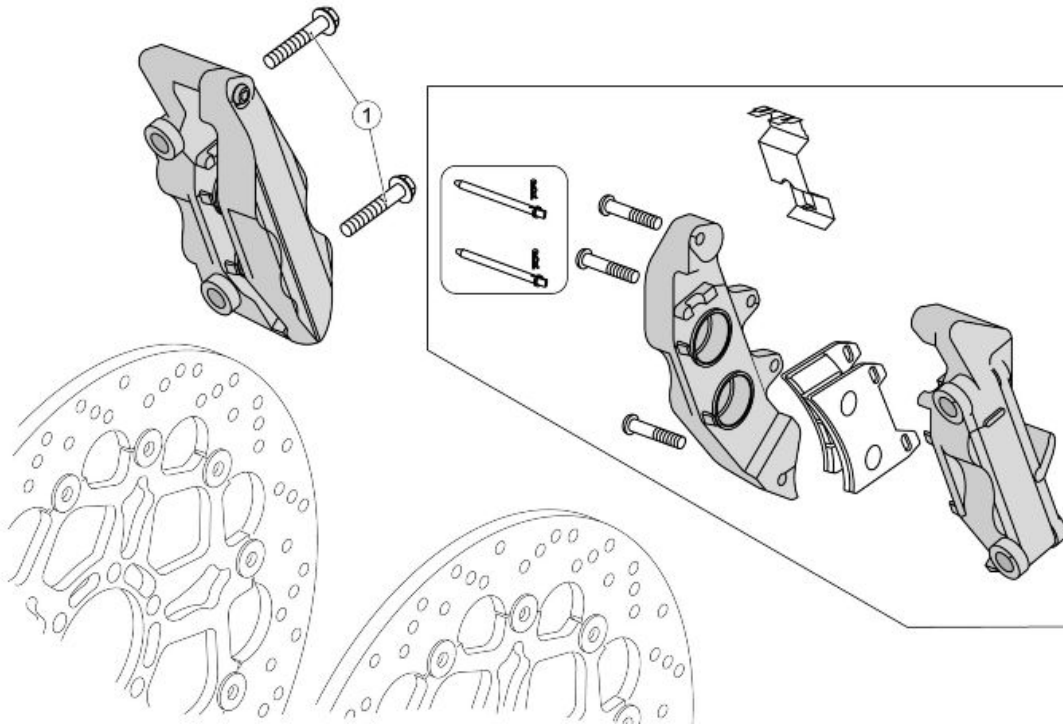
**PINZA FRENO POSTERIORE**

Pos.	Descrizione	Tipo	Quantità	Coppia	Note
1	Viti fissaggio pinza freno posteriore a staffa supporto pinza	M8	2	25 Nm (18.44 lbf ft)	-
2	Perno fissaggio staffa supporto pinza posteriore	-	1	35 Nm (25.81 lbf ft)	-



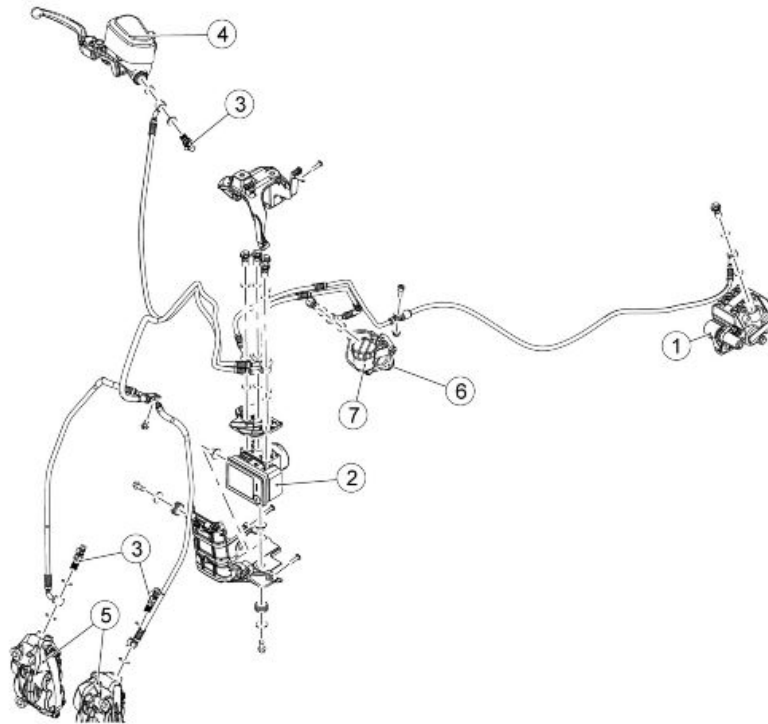
PINZA FRENO ANTERIORE

Pos.	Descrizione	Tipo	Quantità	Coppia	Note
1	Viti fissaggio pinze freno anteriori a piedini forcella	M10	4	50 Nm (36.88 lbf ft)	-

**PINZA FRENO ANTERIORE**

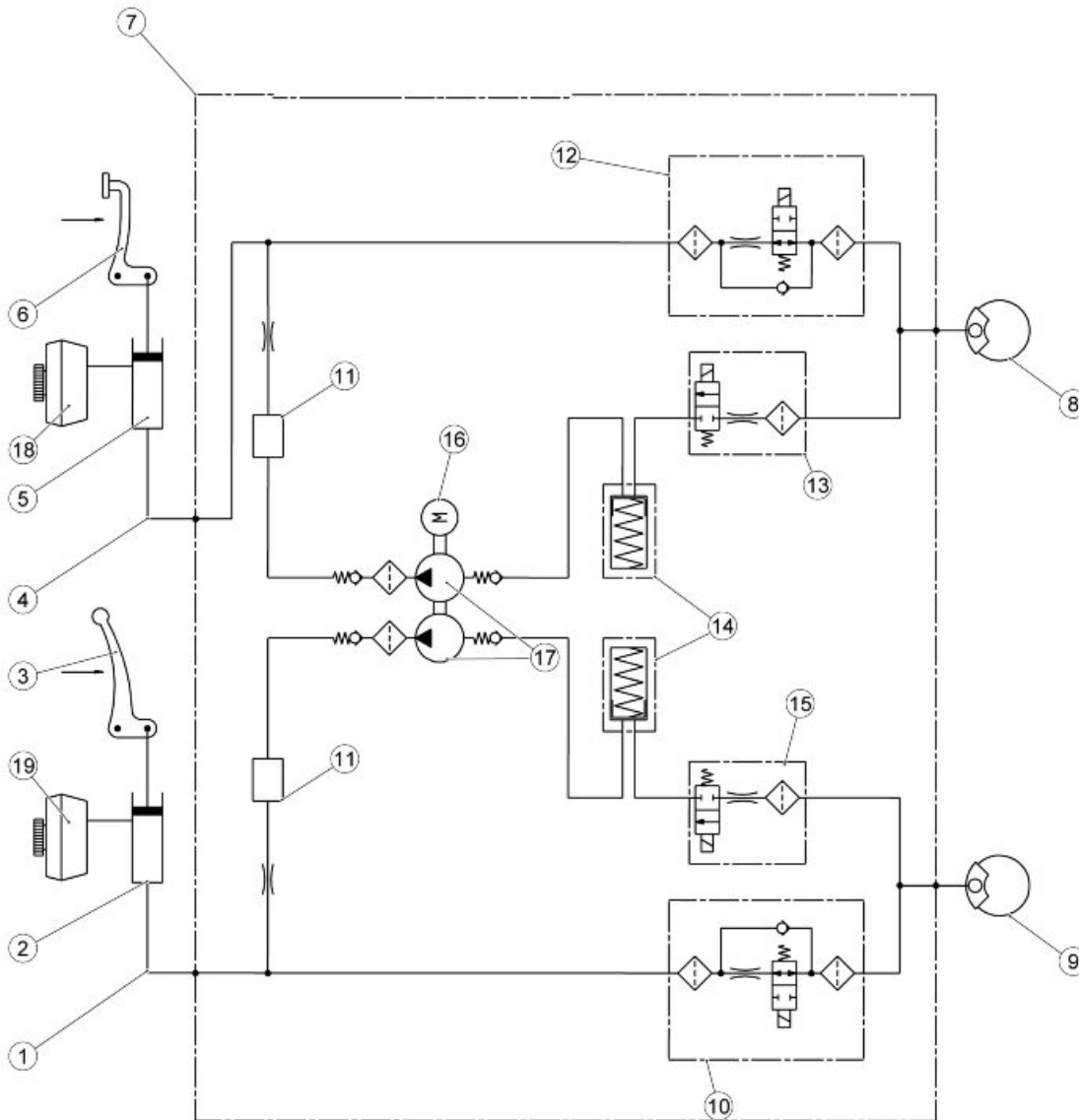
Pos.	Descrizione	Tipo	Quantità	Coppia	Note
1	Viti fissaggio pinze freno anteriori a piedini forcella	M10	4	50 Nm (36.88 lbf ft)	-

Foreword

**Key:**

1. Rear brake calliper
 2. Modulator
 3. Front bleed valve
 4. Front brake reservoir
 5. Front brake callipers
 6. Rear brake pump
 7. Rear brake reservoir
-

Operating diagram



ABS functional diagram key

- 1. Front system circuit
- 2. Front brake master cylinder
- 3. Front brake control lever
- 4. Rear system circuit

5. Rear brake pump
6. Rear brake pedal control
7. ABS control unit
8. Rear brake calliper
9. Front calliper (2 callipers)
10. Front brake circuit intake solenoid valve (normally open)
11. Humidifier
12. Rear brake circuit intake solenoid valve (normally open)
13. Rear brake exhaust circuit solenoid valve (normally closed)
14. Rear/front brake circuit low pressure accumulator
15. Front brake exhaust circuit solenoid valve (normally closed)
16. DC electric motor
17. Double circuit hydraulic pump (ABS)
18. Rear brake reservoir
19. Front brake reservoir

ABS OPERATION

General specifications:

The front circuit is the same as the rear one.

- The ABS inlet valve (10 - 12) is normally open and it is closed only when the system intervenes to avoid wheel locking.
- The exhaust valve (13 - 15) is normally closed and it is opened only when the system intervenes to avoid wheel locking.
- With the system in stand-by mode, the ABS processor controls the wheel speed instant by instant to assess any slippage of the wheels.
- When in standby, the system does not intervene at all when the rider brakes; the braking system is the same as the one without ABS.

ABS Cycle phases (the following operations refer to the front circuit but they are also valid for the rear):

A - Brake activation: the rider starts braking as he would usually do.

B - Pressure reduction: coincides with the recognition of the dangerous situation (wheel slippage exceeds the threshold): the system closes the inlet valve (10-12) and opens the exhaust valve (13-15) temporarily.

At this stage the rider cannot increase the pressure on the callipers (8-9) and the system reduces the pressure on the callipers partially. The excess fluid temporarily fills the front reservoir (18-19) until the ABS pump (17) self-activates and delivers the fluid back to the brake pump (2-5).

C - Maintaining pressure: the pressure in the callipers (8-9) remains low until total recovery of speed / wheel grip.

The system restores the fluid taken from the calliper (8-9) in the section of the system between the brake pump (2-5) and the ABS inlet valve (10-12).

D - Pressure restoration: by opening the inlet valve (10-12) momentarily, the pressure of the callipers (8-9) is increased until maximum deceleration is reached. Then, the system gives the control over the braking back to the rider.

E - If the wheel does not reach complete grip, the system continues operating as before until complete grip is obtained or until the vehicle stops. An error may be shown in the event that the duration of the pressure reduction phase exceeds a predetermined time limit.

ABS SYSTEM DESCRIPTION

The ABS system is a device to avoid wheels locking in case of emergency braking, increasing vehicle braking stability when compared to a traditional braking system.

Sometimes when the brake is operated, the tyre locks with a consequent loss of grip, which makes it difficult to control the vehicle. A position sensor (3) on the tone wheel (2), forming an integral unit with the vehicle wheel, "reads" the status of the vehicle wheel spotting any possible lock.

A control unit (1) signals this out and adjusts the pressure in the braking circuit accordingly.



NOTE

WHEN THE ABS STARTS WORKING, A PULSING IS FELT ON THE BRAKE LEVER.



THE WHEEL ANTILOCK BRAKING SYSTEM DOES NOT PREVENT FALLS WHILE ON A BEND. AN EMERGENCY BRAKING WITH THE VEHICLE INCLINED, HANDLE BAR TURNED, ON UNEVEN OR SLIPPERY ROADS, OR WITH POOR GRIP CREATES LACK OF STABILITY DIFFICULT TO HANDLE. THEREFORE, RIDE CAREFULLY AND SENSIBLY AND ALWAYS BRAKE GRADUALLY. BRAKING WHILE TURNING A CORNER IS SUBJECT TO LAWS OF PHYSICS WHICH NOT EVEN ABS CAN ELIMINATE.

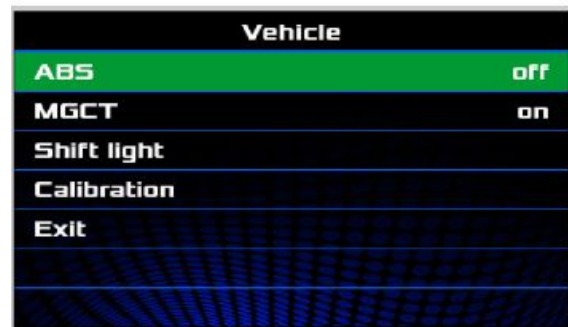
When the sensors (3) detect a significant speed difference between the rear and the front wheels (for example, when rearing up on the back wheel), the ABS system could take this as a dangerous situation.

In this case, there are two possible results:

- The ABS system intervenes by releasing pressure from the calliper until the wheel turns again at the same speed of the other wheel. It is not possible to brake for an instant.
- if the speed difference lasts long, the system may detect an error and deactivate the ABS system. As a consequence, the system works like any regular braking system.

Advanced functions - ABS

- This function allows you to disable the ABS system that is normally active "On".
- Briefly pressing the MODE selector in the middle deactivates the function ("Off") and pressing it again reactivates it ("reactivate").
- Disabling is possible only when the vehicle is in "OFF ROAD" mode. If the riding mode is changed, ABS reactivates.
- To return to the "MENU", briefly press the MODE selector in the middle on "Exit".



CAUTION

IT IS DISABLED ONLY TEMPORARILY, WHEN THE KEY IS INSERTED THE SYSTEM IS ALWAYS ACTIVE.

CAUTION

DISABLING IS POSSIBLE ONLY WHEN THE VEHICLE IS IN "OFF ROAD" MODE. IF THE RIDING MODE IS CHANGED, ABS REACTIVATES. IF DISABLED, THE ABS INDICATOR LIGHT STAYS ON STEADY.

- Upon starting the vehicle, after the initial instrument panel check, the ABS warning light flashes until a speed of 5 kph (3.11 mph) is exceeded and then it switches off or continues to flash even after exceeding the speed of 5 kph (3.11 mph).
- If the ABS warning light continues flashing or is permanently on, a failure has been detected and the ABS has been automatically deactivated.



Characteristic

Distance between tone wheel and front sensor

0.1 - 3.17 mm (0.004 - 0.125 in)

Distance between tone wheel and rear sensor

0.1 - 3.10 mm (0.004 - 0.122 in)

- In OFF ROAD mode, the ABS system deactivates automatically for the rear wheel.

CAUTION

ONLY IN THIS MODE DOES THE ABS SYSTEM STAY ACTIVE EXCLUSIVELY FOR THE FRONT WHEEL AND THE DEDICATED SYMBOL APPEARS ON THE DISPLAY TO REMIND THE RIDER TO TAKE PARTICULAR CARE.



Guide to diagnosis

PREMISE

Each time the key is ON, if, at least one current or stored* error is detected, the ABS warning light turns on permanently.

The ABS system is deactivated automatically

The system operates perfectly just as any other braking system without ABS

* The diagnosis requires exceeding the 5 km/h (3.1 mph).



Each time the key is ON, if at least one current or stored* error of the ABS system is not detected:

- the abs warning light flashes.

When the 5 km/h (3.1 mph) are exceeded:

- if errors are not detected: the ABS warning light turns off
- if at least one malfunction is detected: the ABS warning light turns on permanently.

The ABS system is disabled!

The system operates perfectly just as any other braking system without ABS.

The detection of malfunctions may require more or less time according to the type of failure.

Error detection logic foresees that for the errors to be diagnosed one or more conditions must persist within a given time.

If during this given time one of the conditions is missing but then it comes back, the timer is reset and the system is no longer able to diagnose the error.

The ABS system continues to be inactive.

Example:

- error code **5D93** requires some minutes before it is diagnosed during the given time: the ABS warning light ABS keeps flashing.

GUIDE TO ABS FAULT DIAGNOSIS

1. ABS LAMP ON

2. CONNECT THE DIAGNOSTIC TOOL

DOES THE DIAGNOSTIC TOOL COMMUNICATE? (NO, go to 3; YES, go to 4)

3. PERFORM THESE CHECKS:

- A. Ground connection PIN 1
- B. +12V at PIN 18

4. ARE THERE ANY ERRORS? YES, go to point 5; NO, go to 6)

5. CHECK THE ERRORS TABLE

6. ABS WARNING LIGHT ACTIVATION

IS IT ACTIVATED?(YES, go to point 7; NO, go to point 8)

7. CONTACT TECHNICAL SERVICE

8. PERFORM THESE CHECKS:

- A. Cable continuity between PIN 8 of the ABS control unit connector and PIN40 of the instrument panel.
- B. Check connectors - refer to the operations described in the chapter

If the previous checks are OK, the causes might be:

- C. ABS control unit malfunction
- D. Instrument panel malfunction

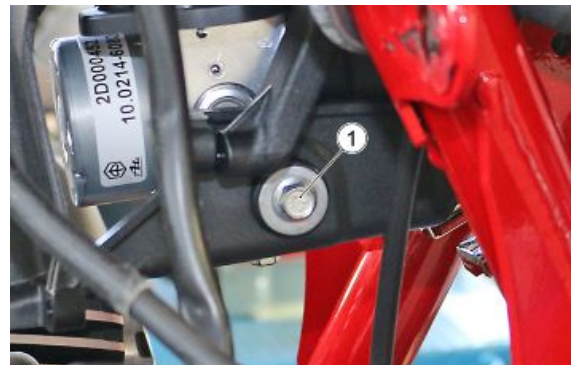
Modulator

REMOVAL

- Remove the engine from the vehicle

PREPARING THE VEHICLE

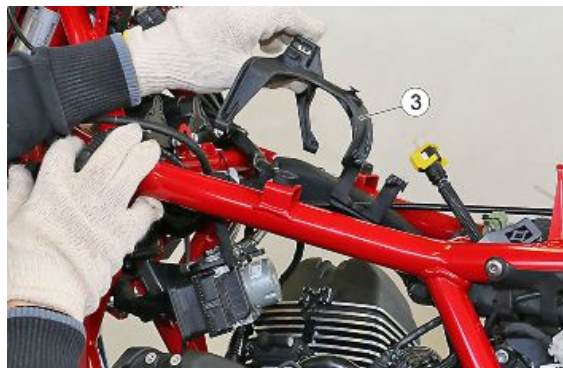
- Connect the bleeder bottles to the front and rear calliper bleeder screws and open them.
- Press the front brake lever and the rear brake pedal as far as they will go and block them in position using the clamping devices. Close the front and rear calliper bleeder screws and remove the bleeder bottle
- Mark a reference on the pipes and on the ABS control unit to avoid inverting them when refitting
- Undo and remove the screw (1)



- Undo and remove the screw (2)



- Remove the support bracket (3)



- Disconnect the connector (4)



- Unscrew and remove the screws (5)
- Remove the ABS control unit (6)

NOTE

FIRST OF ALL, DISCONNECT THE LINES BETWEEN THE ABS CONTROL UNIT AND THE BRAKE MASTER CYLINDERS AND SEAL THE OPEN COUPLINGS ON THE ABS CONTROL UNIT IMMEDIATELY USING PROTECTIVE PLUGS. NEXT, REMOVE THE LINES BETWEEN THE ABS CONTROL UNIT AND THE BRAKE CALLIPERS AND SEAL THESE COUPLINGS USING PROTECTIVE PLUGS TOO.



INSTALLATION

- Remove the ABS modulator
- Install the new completely pre-filled ABS control unit

- In order to ensure that the brake fluid remains inside the ABS control unit, first remove the protective plugs from the braking circuit couplings and connect the corresponding lines.
- Once all the braking circuit lines have been connected, remove the protective plugs from the couplings of the brake master cylinders and connect the respective lines to the ABS control unit.
- Remove the clamp from the front brake lever and the rear brake pedal
- Remove the caps from the reservoirs and fill them with new brake fluid

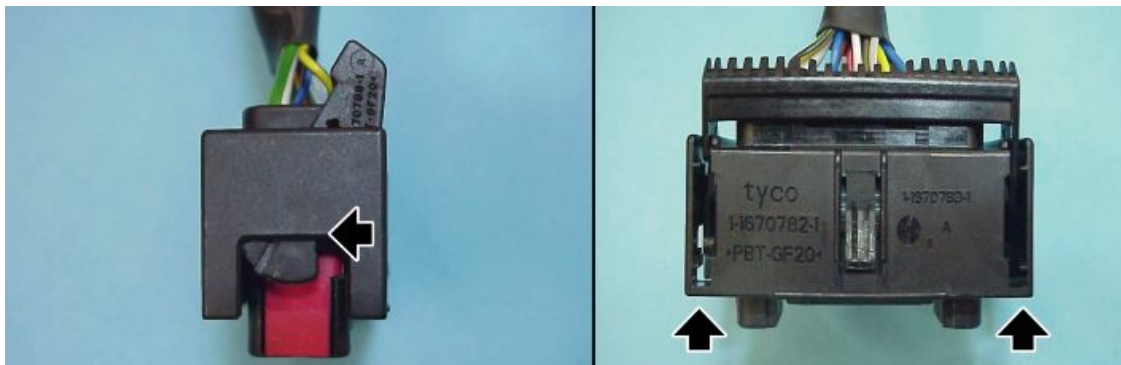
CAUTION

PERFORM THE STANDARD BRAKING SYSTEM BLEEDING PROCEDURE, AS DESCRIBED AT THE END OF THE CHAPTER.

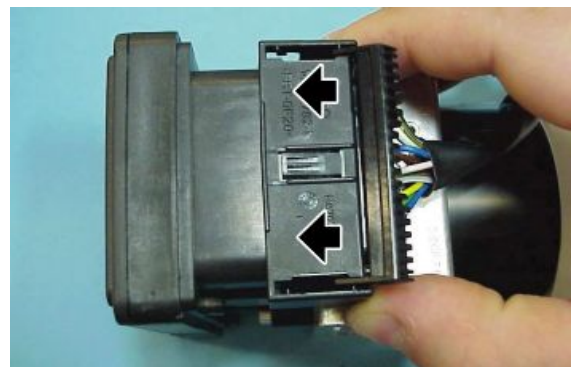
- Fill the reservoirs and refit the caps
- Check the stroke and sensitivity of the front brake lever and the rear brake pedal
- If the brake pedal or lever stroke is too long after carrying out the bleeding procedure, check the braking system for leaks and, if none are found, bleed the system using the diagnostic tool, as described.
- Disconnect the flexible bleeder pipes and re-tighten the bleeder screws, applying the correct torque

ABS CONTROL UNIT CONNECTOR INSERTION PROCEDURE

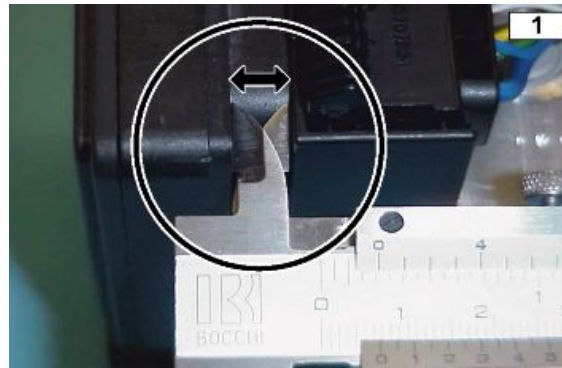
- Check the initial position of the connection clip lever.



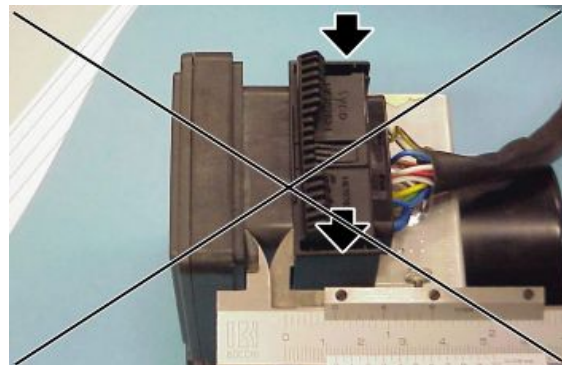
- When the connector is fully inserted, the distance between the connector and the ABS control unit must be 7.5 mm (0.29 in).



- If the initial position of the connector and the driving lever is not that shown in fig. 1, the connector will not be properly coupled and the distance measured will be greater (12 mm approx. (0.47 in)). In this case repeat the operation as described in the two previous points.

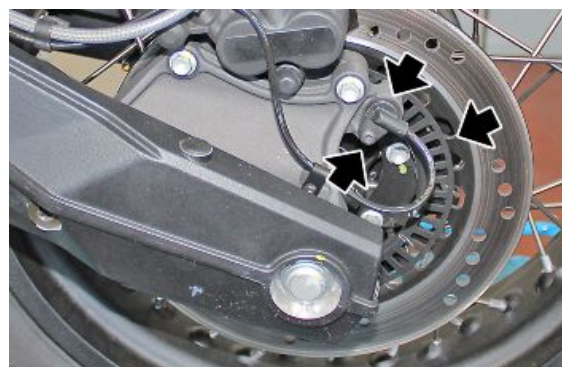


IT IS ADVISABLE TO CREATE A TEMPLATE TO CHECK THE CORRECT CONNECTOR INSERTION.



Component maintenance

- The vehicle is equipped with two-channel ABS. In other words, it works on both the front and rear wheel. Periodically and each time the wheels are re-mounted, the phonic wheel or the sensor is replaced, it is important to check that the distance is consistent over all 360°. To do this, use a feeler gauge and check the distance between the sensor and the phonic wheel on three points at a distance of 120°.



CAUTION

IF THE READINGS SHOULD RETURN A VALUE OUTSIDE OF THE FIELD OF TOLERANCE, REPLACE THE SENSOR AND/OR THE PHONIC WHEEL AND REPEAT THE CHECK IN ORDER TO ENSURE THAT THE VALUES FALL WITHIN THE FIELD OF TOLERANCE.

Characteristic

Distance between tone wheel and front sensor
0.1 - 3.17 mm (0.004 - 0.125 in)

Distance between tone wheel and rear sensor

0.1 - 3.10 mm (0.004 - 0.122 in)

CLEANING THE PHONIC WHEELS

- It is important to check that both phonic wheels are always clean. If not: delicately remove any dirt residues using a cloth or wire brush. Do not use solvents or abrasive substances and do not direct air or water jets directly on the phonic wheel.

REPLACING THE PHONIC WHEEL SENSOR

- Disconnect the front phonic wheel sensor connector from the main wiring harness. Unscrew and remove the screws and remove the phonic wheel sensor

CAUTION

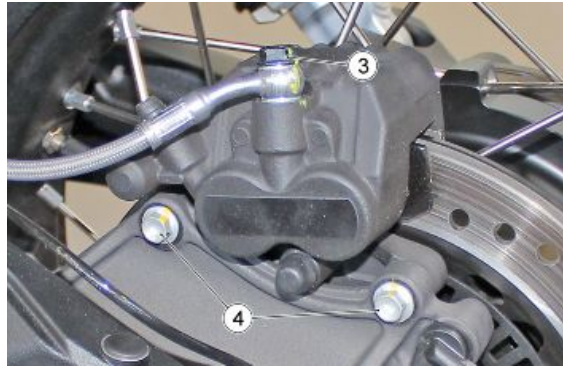
BEFORE REFITTING, ENSURE THAT THE CONTACT SURFACES BETWEEN THE SENSOR AND THEIR SEATS ARE FREE OF IMPERFECTIONS AND PERFECTLY CLEAN. ALWAYS CHECK THE DISTANCE BETWEEN THE SENSOR AND THE PHONIC WHEEL.

Removal

- Connect the bleeder bottles to the calliper bleeder screw and open
- Press the lever down as far as it will go and block it in position using a clamping device in order to prevent the liquid from escaping from the system when it is open.
- Close the calliper bleeder screw and remove the bleeder bottle.
- Loosen the two grub screws (1)
- Free the brake calliper line from the cable grommet (2)



- Unscrew and remove the joint screw (3) from the rear calliper
- Unscrew and remove the screws (4)



- Remove the rear calliper (5)

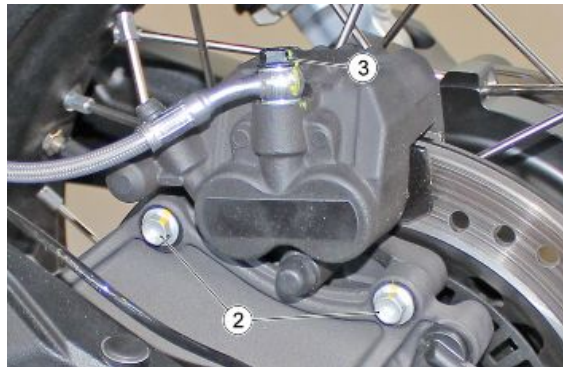


Installing

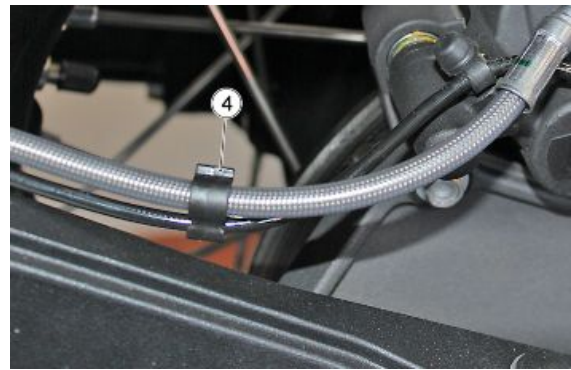
- Remove the rear brake calliper
- Correctly position the new rear brake calliper (1) on the brake disc



- Insert and tighten the screws (2)
- Position the brake line, insert and tighten the screw (3)



- Hook the brake line into the cable grommet (4)



- Insert and tighten the two grub screws (5)



- Remove the clamp from the brake pedal.
- Remove the brake fluid reservoir cap and fill it with new brake fluid

CAUTION

PERFORM THE STANDARD BRAKING SYSTEM BLEEDING PROCEDURE, AS DESCRIBED AT THE END OF THE CHAPTER.

- Top up the fluid reservoir and refit the cap
- Check the stroke and sensitivity of the brake pedal
- If the brake pedal stroke is too long after carrying out the bleeding procedure, check the braking system for leaks and, if none are found, bleed the system using the diagnostic instrument, as described
- Disconnect the flexible bleeder pipes and re-tighten the bleeder screws, applying the correct torque

Removal

The following procedure is described for a single calliper, but is valid for both front brake callipers.

- Connect the bleeder bottles to the calliper bleeder screw and open
 - Press the lever down as far as it will go and block it in position using a clamping device in order to prevent the liquid from escaping from the system when it is open.
 - Close the calliper bleeder screw and remove the bleeder bottle.
 - Unscrew and remove the joint screw (1) from the front calliper
 - Unscrew and remove the two screws (2)
-
- Remove the front brake calliper (3)

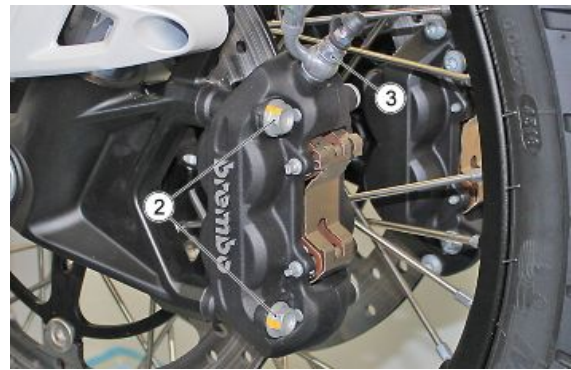


Installing

- Remove the front brake calliper
- Correctly position the new front brake calliper (1) on the brake disc



- Insert and tighten the screws (2)
- Position the brake line on the brake calliper and insert and tighten the screw (3)



- Remove the clamp from the front brake lever.
- Remove the brake fluid reservoir cap and fill it with new brake fluid

CAUTION

PERFORM THE STANDARD BRAKING SYSTEM BLEEDING PROCEDURE, AS DESCRIBED AT THE END OF THE CHAPTER.

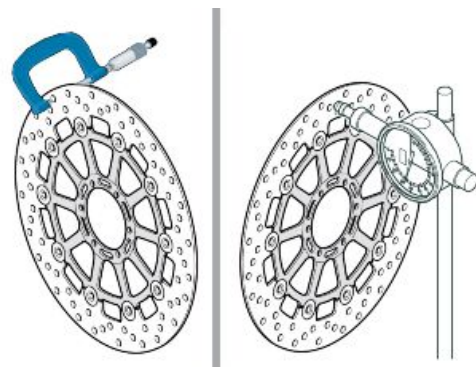
- Top up the fluid reservoir and refit the cap
- Check the stroke and sensitivity of the brake lever
- If the brake lever stroke is too long after carrying out the bleeding procedure, check the braking system for leaks and, if none are found, bleed the system using the diagnostic instrument, as described
- Disconnect the flexible bleeder pipes and re-tighten the bleeder screws, applying the correct torque

Disc Inspection

FRONT**CAUTION**

THE FRONT BRAKE DISC SHAPE DOES NOT CHANGE THE OPERATING AND MAINTENANCE SPECIFICATIONS OF THE SYSTEM.

- The following operations must be carried out with the brake discs fitted on the wheel; they refer to a single disc, but are valid for both.
- Check the disc for wear by measuring the minimum thickness with a micrometer in different points. If the minimum thickness, even in a single point of the disc, is less than the minimum value, replace the disc.



Disc thickness minimum value: 4 mm (0.16 in)

- Using a dial gauge, check that the maximum oscillation of the disc does not exceed the tolerance; otherwise, replace it.

Disc oscillation tolerance: 0.15 mm (0.0059 in), with respect to the wheel centre line.

Removal

The following procedure is described for a single calliper, but is valid for both front brake callipers.

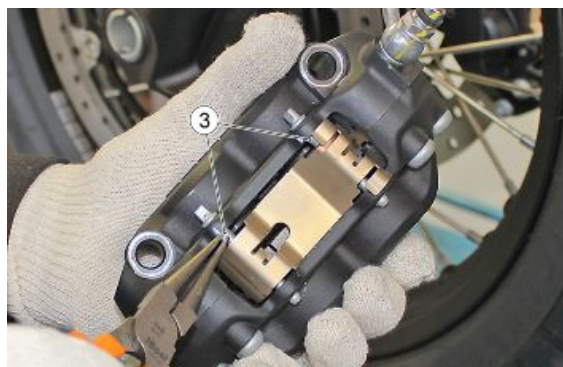
- Unscrew and remove the screws (1)



- Remove the front brake calliper (2) from the brake disc



- Remove the two retaining springs (3)



- Remove the two pins (4)



- Remove the spring (5)



- Remove the brake pads (6) one at a time

CAUTION

AFTER REMOVING THE PADS, DO NOT OPERATE THE BRAKE LEVER OR THE CALLIPER PLUNGERS COULD GO OUT OF THEIR SEATS RESULTING IN BRAKE FLUID LEAKAGE.



Installing

The following procedure is described for a single calliper, but is valid for both front brake callipers

- Insert the new pads correctly (1)

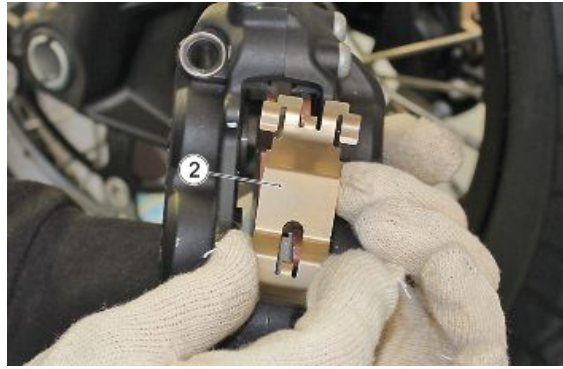
CAUTION



ALWAYS REPLACE BOTH PADS AND MAKE SURE THEY ARE CORRECTLY POSITIONED INSIDE THE CALLIPER.



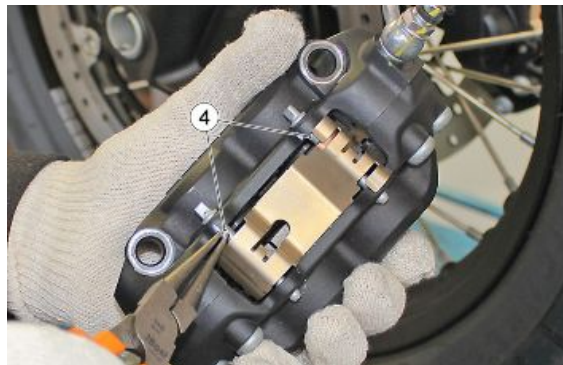
- Insert the spring (2)



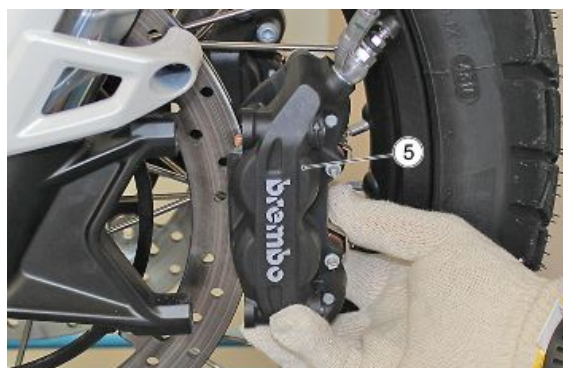
- Insert the two pins (3)



- Insert the two retaining springs (4)



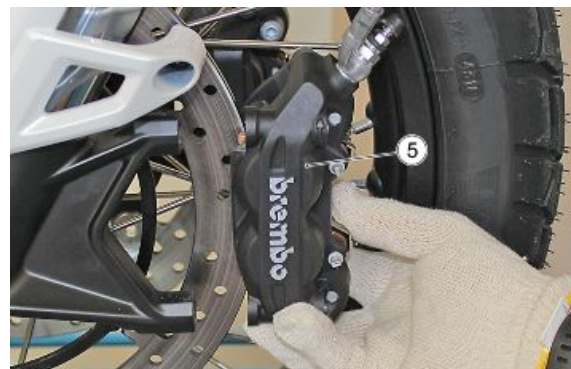
- Insert the front brake calliper (5) on the brake disc



- Insert the two screws (6) and tighten them



- Insert the front brake calliper (5) on the brake disc



- Insert the two screws (6) and tighten them

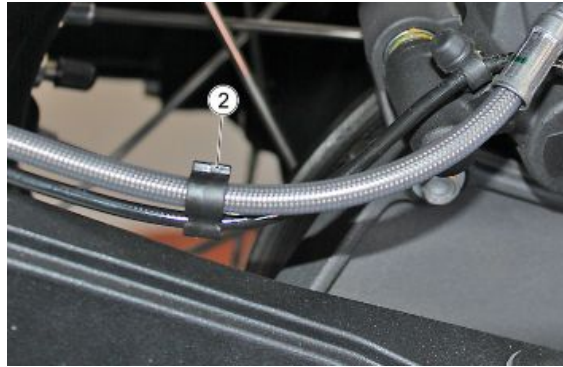


Removal

- Connect the bleeder bottles to the caliper bleeder screw and open
- Press the lever down as far as it will go and block it in position using a clamping device in order to prevent the liquid from escaping from the system when it is open.
- Close the calliper bleeder screw and remove the bleeder bottle.
- Loosen the two grub screws (1)



- Free the brake calliper line from the cable grommet (2)



- Unscrew and remove the two screws (3)



- Remove the rear brake calliper (4) from the brake disc



- Unscrew and remove the two grub screws (5).



- Remove the brake pads (6) one at a time

CAUTION

AFTER REMOVING THE PADS, DO NOT OPERATE THE BRAKE LEVER OR THE CALLIPER PLUNGERS COULD GO OUT OF THEIR SEATS RESULTING IN BRAKE FLUID LEAKAGE.

**Installing**

- Insert the new pads correctly (1)

CAUTION

ALWAYS REPLACE BOTH PADS AND MAKE SURE THEY ARE CORRECTLY POSITIONED INSIDE THE CALLIPER.



- Insert and tighten the grub screws (2)



- Insert the rear brake calliper (3) on the brake disc



- Insert and tighten the screws (4)



- Insert the brake calliper line into the cable grommet (5)



- Tighten the two grub screws (2)



Bleeding the braking system

PREPARING THE VEHICLE

- It is important to ensure that there is always a sufficient quantity of brake fluid in the tank.
- These operations may be simplified by using a bleeding device when carrying out the "Replacing the brake fluid" operations
- In this case, when performing the bleeding procedure, it is also necessary to operate the brake pedal a few times with the bleeder device connected (approximately five times for each wheel circuit).

FRONT/REAR BRAKE MASTER CYLINDER

PRELIMINARY OPERATIONS

- Replace the damaged brake master cylinder with a new one
- Connect the brake line to the new brake master cylinder
- Fill the reservoir with new brake fluid

CAUTION

PERFORM THE STANDARD BRAKING SYSTEM BLEEDING PROCEDURE, AS DESCRIBED AT THE END OF THE CHAPTER.

- Top up and refit the cap
- Check the stroke and sensitivity of the brake pedal and lever
- If the brake pedal or lever stroke is too long after carrying out the bleeding procedure, check the braking system for leaks and, if none are found, bleed the system using the diagnostic tool, as described.
- Disconnect the flexible bleeder pipes and re-tighten the bleeder screws, applying the correct torque

BLEEDING SYSTEM WITH DIAGNOSTICS INSTRUMENT

This type of bleeding has to be carried out if after all the checks the brake lever and the pedal are still spongy.

The operations described here are valid for both systems even though the description refers to the front system.

FRONT

- With diagnostics instrument properly connected, select the function "FRONT BRAKE BLEEDING PROCEDURE".
- The pump starts rotating.
- While the pump is performing a rotation cycle, operate and release the front brake lever until the message diagnostics instrument cycle completion is received.
- This procedure allows the air to turn and to accumulate.
- Once the procedure with diagnostics instrument is finished, perform the REGULAR BLEEDING to remove the air from the system completely.

CAUTION

PERFORM THE STANDARD BRAKING SYSTEM BLEEDING PROCEDURE, AS DESCRIBED AT THE END OF THE CHAPTER.

Front

Any air trapped in the hydraulic circuit acts as a cushion, absorbing much of the pressure applied by the brake pump and minimising the braking power of the calliper.

The presence of air is signalled by the "sponginess" of the brake and by poor braking.



IN VIEW OF THE DANGER THIS POSES FOR VEHICLE AND RIDER, THE HYDRAULIC CIRCUIT MUST BE BLED AFTER REFITTING THE BRAKES AND RESTORING THE BRAKING SYSTEM TO ITS NORMAL OPERATING CONDITIONS.

NOTE

THE FOLLOWING OPERATIONS REFER TO ONE FRONT BRAKE CALLIPER ONLY, BUT ARE VALID FOR BOTH. THE VEHICLE MUST BE ON LEVEL GROUND TO BE BLED. WHILE BLEEDING THE HYDRAULIC SYSTEM, FILL THE RESERVOIR WITH THE NECESSARY QUANTITY OF BRAKE FLUID. CHECK THAT, DURING THE OPERATION, THERE IS ALWAYS BRAKE FLUID IN THE RESERVOIR.

- Remove the rubber protection cover of the bleed valve.
- Insert the transparent plastic pipe in the front brake calliper bleed valve and slide the other end of this pipe in a container to collect the fluid.
- Remove the front brake fluid reservoir cap.
- Quickly press and release the front brake lever several times and then keep it fully pressed.
- Loosen the bleed valve by a 1/4 turn so that the brake fluid flows into the container, this will release the tension on the brake lever, risking making it arrive at the end stop.
- Close the bleed valve before arriving at the end of the stroke with the lever.
- Repeat the operation until there are no air bubbles in the fluid going into the container.

**NOTE**

WHILE BLEEDING THE HYDRAULIC SYSTEM, FILL THE RESERVOIR WITH THE NECESSARY QUANTITY OF BRAKE FLUID. CHECK THAT, DURING THE OPERATION, THERE IS ALWAYS BRAKE FLUID IN THE RESERVOIR.

- Screw the bleeding valve and remove the pipe.
- Top-up the reservoir until the correct brake fluid level is obtained.
- Refit and block the front brake oil reservoir cap.
- Refit the rubber protection cover.



Rear

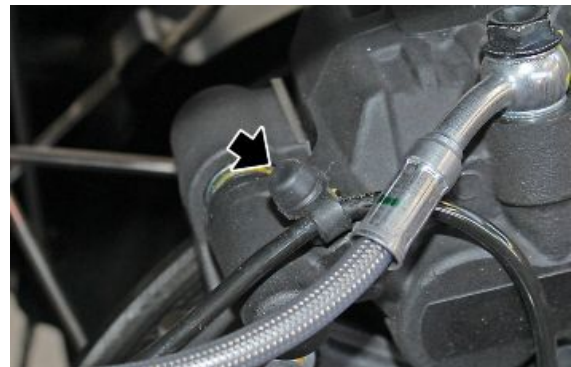
Any air trapped in the hydraulic circuit acts as a cushion, absorbing much of the pressure applied by the brake pump and minimising the braking power of the calliper.

The presence of air is signalled by the "sponginess" of the brake and by poor braking.

CAUTION

IN VIEW OF THE DANGER THIS POSES FOR VEHICLE AND RIDER, THE HYDRAULIC CIRCUIT MUST BE BLED AFTER REFITTING THE BRAKES AND RESTORING THE BRAKING SYSTEM TO ITS NORMAL OPERATING CONDITIONS. THE VEHICLE MUST BE ON LEVEL GROUND TO BE BLED. WHILE BLEEDING THE HYDRAULIC SYSTEM, FILL THE RESERVOIR WITH THE NECESSARY QUANTITY OF BRAKE FLUID. CHECK THAT, DURING THE OPERATION, THERE IS ALWAYS BRAKE FLUID IN THE RESERVOIR.

- Remove the rubber protection cover of the bleed valve.
- Insert the transparent plastic pipe in the rear brake calliper bleed valve and insert the other end of this pipe into a container to collect the fluid.
- Remove the rear brake fluid reservoir cap.
- Repeatedly quickly pull and release the rear brake lever, then keep it fully pulled.
- Loosen the bleed valve by a 1/4 turn so that the brake fluid flows into the container, this will release the tension on the brake lever, risking making it arrive at the end stop.
- Close the bleed valve before arriving at the end of the stroke with the lever.
- Repeat the operation until there are no air bubbles in the fluid going into the container.



NOTE

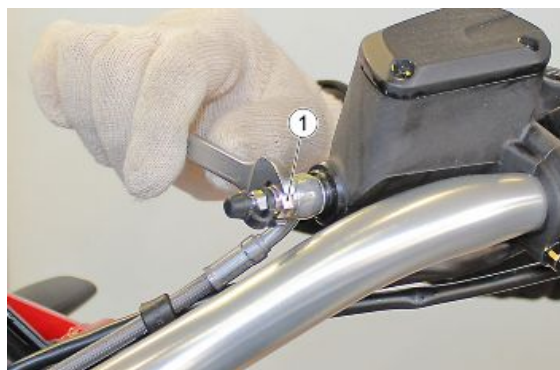
WHEN BLEEDING THE HYDRAULIC SYSTEM, FILL THE TANK WITH BRAKE FLUID WHEN NECESSARY CHECK THAT DURING THE OPERATION THERE IS ALWAYS BRAKE FLUID.

- Screw the bleeding valve and remove the pipe.
- Top-up the reservoir until the correct brake fluid level is obtained.
- Refit and lock the rear brake oil reservoir cap.
- Refit the rubber protection cover.



Removal

- Undo and remove the joint screw (1) from the front brake master cylinder after placing a suitable container underneath to collect the brake fluid



- Unscrew and remove the screws (2)



- Remove the U-bolt (3)



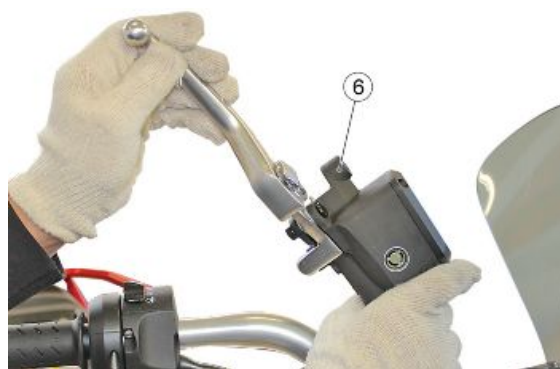
- Unscrew and remove the two screws (4)



- Remove the sensor (5) from the front brake master cylinder



- Remove the front brake master cylinder (6)



Rimozione

- Unscrew and remove the two screws (1)



- Remove the protection cover (2)



- Undo and remove the joint screw (3) from the rear brake master cylinder after placing a suitable container underneath to collect the brake fluid.



- Remove the rear brake master cylinder (4)



REAR BRAKE FLUID RESERVOIR REMOVAL

- Remove the rear brake master cylinder
- Undo and remove the screw (1)
- Retrieve the support bracket (2)
- Remove the hose guide (3)
- Remove the brake fluid reservoir (4)

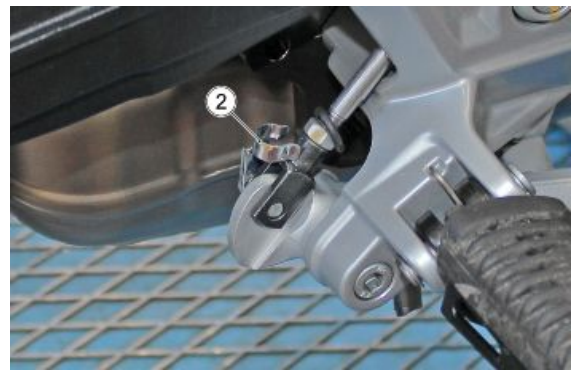


**REMOVING THE REAR MASTER CYLINDER
PLUNGER**

- Slide out the O-ring gasket (1) to free the locking clip



- Remove the locking clip (2)



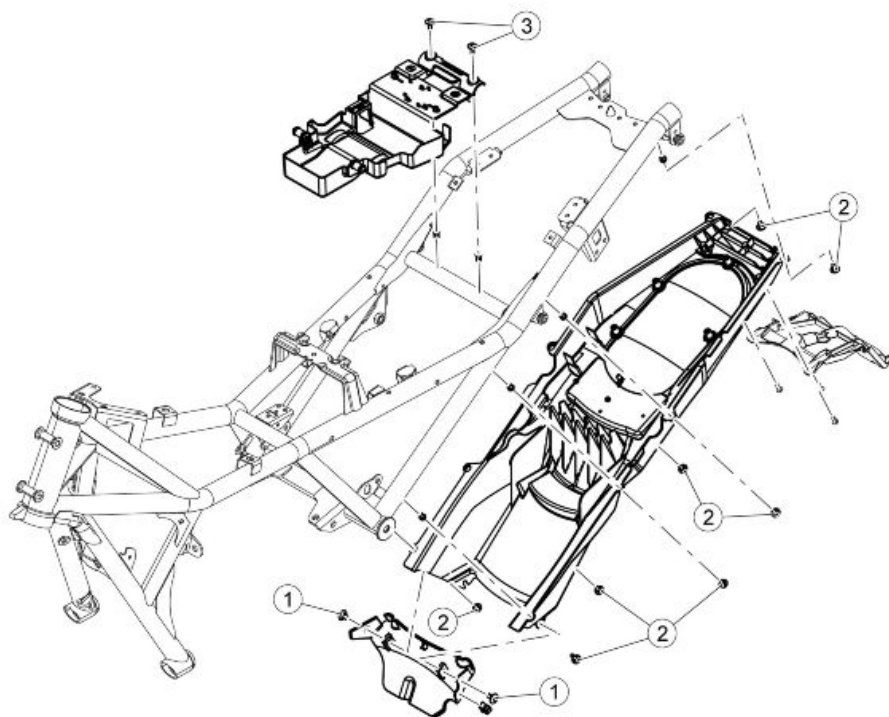
- Remove the rear brake master cylinder plunger (3)



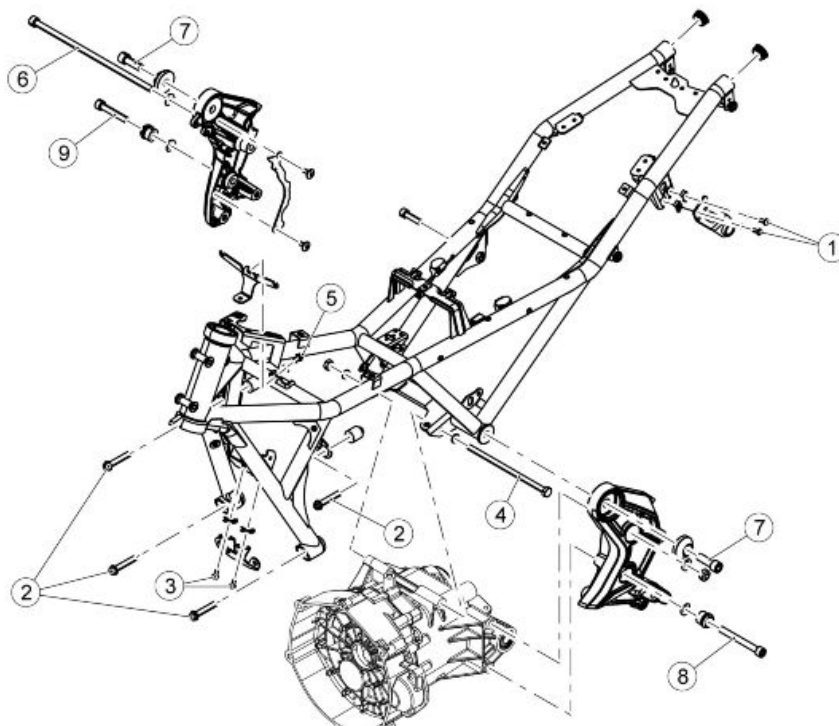
INDEX OF TOPICS

BODYWORK

BODYW

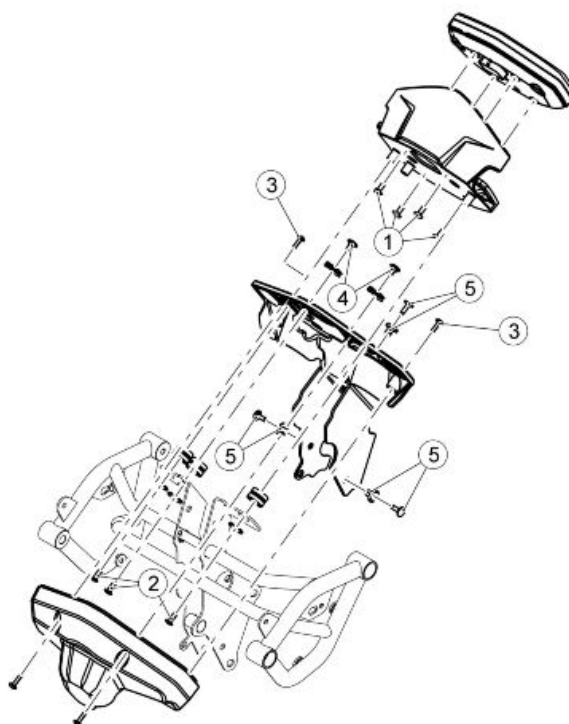
**VANO SOTTOSELLA**

Pos.	Descrizione	Tipo	Quantità	Coppia	Note
1	Vite fissaggio passatubo freno anteriore a scatola batteria	M5	2	6 Nm (4.43 lbf ft)	-
2	Viti fissaggio scatola batteria a telaio	M5	8	6 Nm (4.43 lbf ft)	-
3	Viti fissaggio staffa batteria/vano portaoggetti a telaio	M5	2	6 Nm (4.43 lbf ft)	-

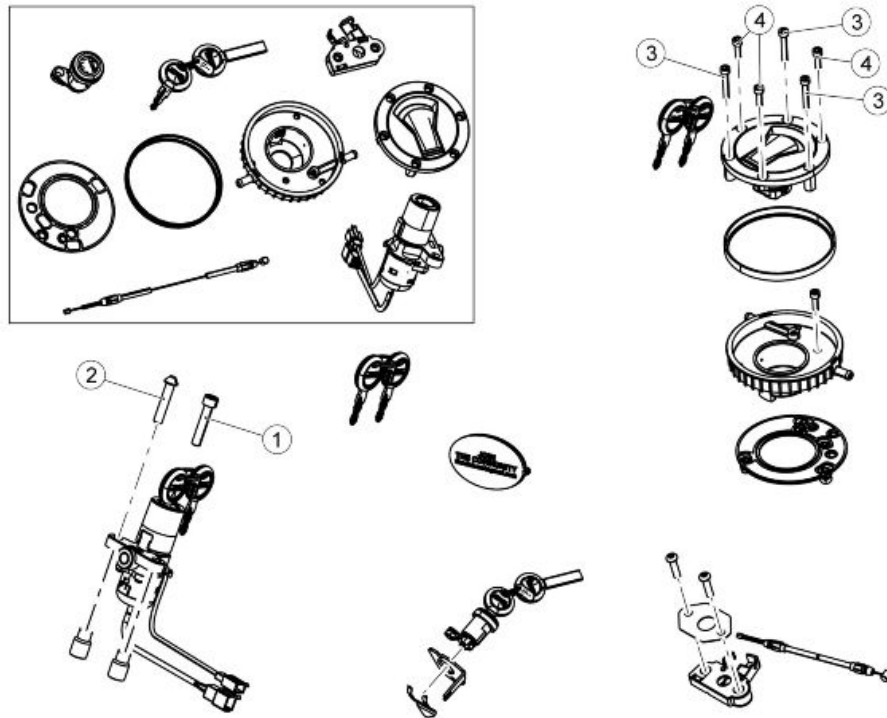


TELAIO

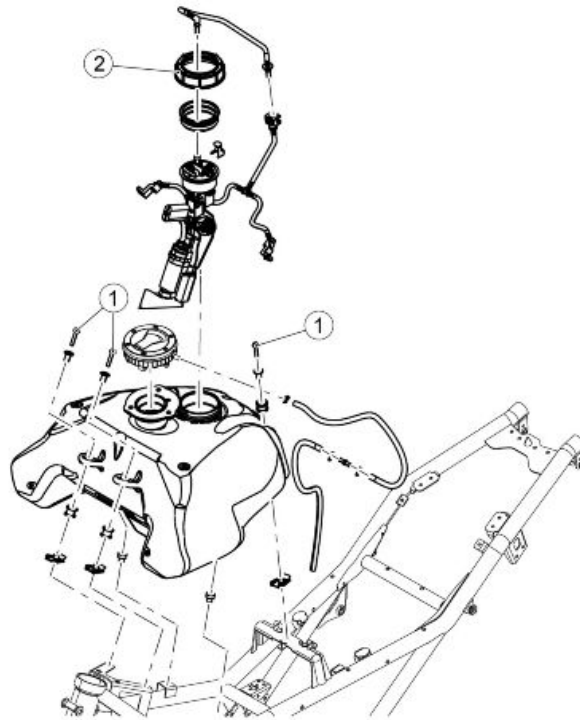
Pos.	Descrizione	Tipo	Quantità	Coppia	Note
1	Viti fissaggio staffa supporto silenziatore a telaio	M6	2	10 Nm (7.38 lbf ft)	-
2	Viti fissaggio telaio a motore	M10	4	50 Nm (36.88 lbf ft)	-
3	Viti fissaggio staffa supporto regolatore tensione a telaio	M6	2	10 Nm (7.38 lbf ft)	-
4	Vite fissaggio telaio a cambio	M10	1	50 Nm (36.88 lbf ft)	-
5	Vite fissaggio piastra supporto bobine a telaio	M8	1	25 Nm (18.44 lbf ft)	-
6	Vite fissaggio piastra destra telaio e piastra sinistra telaio a cambio	M10	1	50 Nm (36.88 lbf ft)	Con dado
7	Vite fissaggio piastra destra telaio a telaio	M12	2	80 Nm (59.00 lbf ft)	-
8	Vite fissaggio piastra sinistra telaio a cambio	M10	1	50 Nm (36.88 lbf ft)	-
9	Vite fissaggio piastra destra telaio a cambio	M10	1	50 Nm (36.88 lbf ft)	-

**STRUMENTI**

Pos.	Descrizione	Tipo	Quantità	Coppia	Note
1	Viti fissaggio cruscotto a palpebra cruscotto	M5	4	6 Nm (4.43 lbf ft)	-
2	Viti fissaggio palpebra cruscotto a telaio anteriore	Autofilettante 5x14	3	3 Nm (2.21 lbf ft)	-
3	Viti fissaggio chiusura plancia a plancia	Autofilettante 3.3x16	4	2 Nm (1.48 lbf ft)	-
4	Viti fissaggio superiore plancia a telaio anteriore	M5	2	6 Nm (4.43 lbf ft)	-
5	Rivetto fissaggio inferiore plancia a telaio anteriore	-	2	-	A pressione

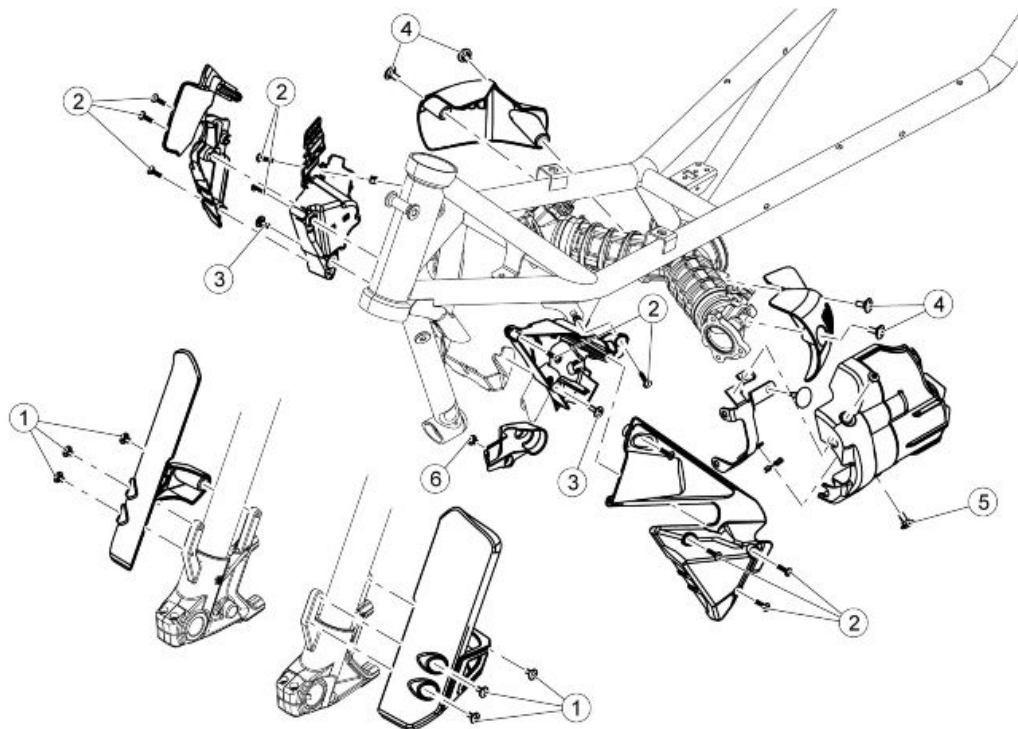
**SERRATURE**

Pos.	Descrizione	Tipo	Quantità	Coppia	Note
1	Vite fissaggio commutatore di accensione a telaio	M8	1	25 Nm (18.44 lbf ft)	-
2	Vite fissaggio commutatore di accensione a telaio	M8	1	-	Vite a strappo fino a rottura
3	Viti fissaggio tappo serbatoio carburante a serbatoio carburante	M5	3	6 Nm (4.43 lbf ft)	-
4	Viti fissaggio tappo serbatoio carburante a serbatoio carburante	M5	4	6 Nm (4.43 lbf ft)	-



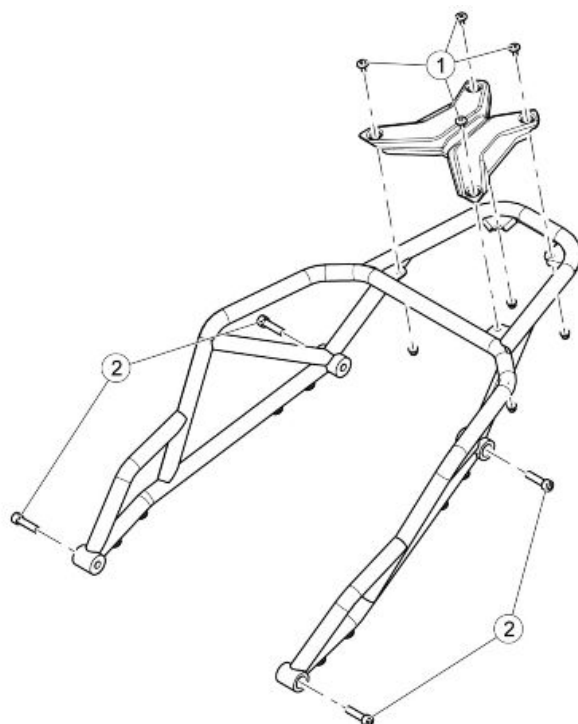
SERBATOIO BENZINA

Pos.	Descrizione	Tipo	Quantità	Coppia	Note
1	Viti fissaggio serbatoio carburante a telaio	M6	3	10 Nm (7.38 lbf ft)	-
2	Ghiera fissaggio pompa carburante a serbatoio carburante	-	1	20 Nm (14.75 lbf ft)	-

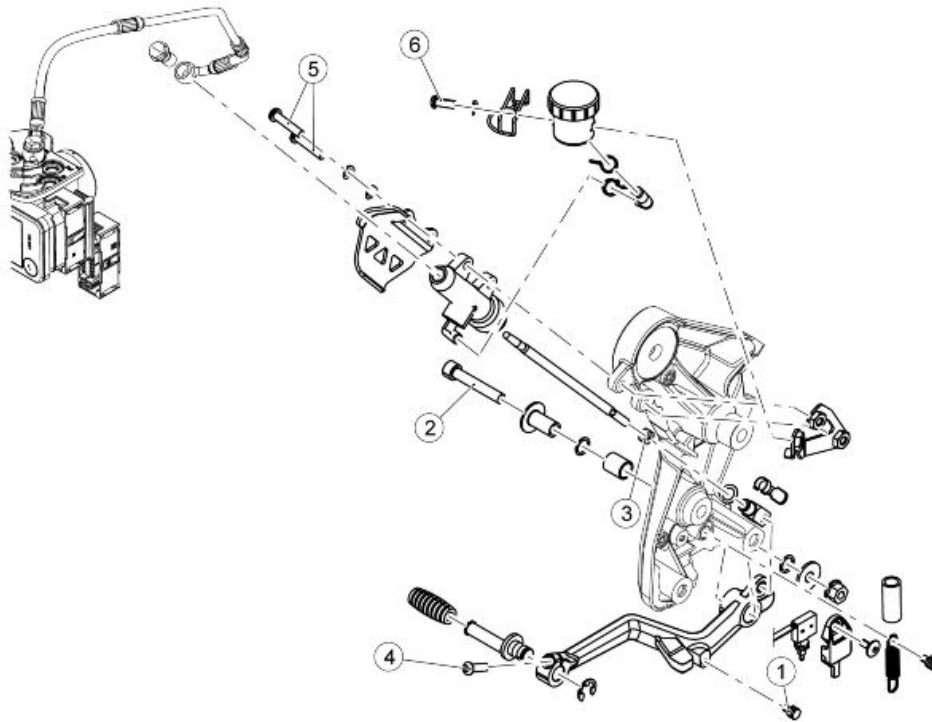


PROTEZIONI

Pos.	Descrizione	Tipo	Quantità	Coppia	Note
1	Viti fissaggio parasteli a steli forcella	M5	6	6 Nm (4.43 lbf ft)	-
2	Viti fissaggio coperture canotto a scatole connettori	Autofilettanti 3x20	11	3 Nm (2.21 lbf ft)	-
3	Viti fissaggio inferiore scatole connettori a telaio	M5	2	6 Nm (4.43 lbf ft)	-
4	Perno fissaggio aggancio molla leva freno posteriore a piastra telaio	M5	4	3 Nm (2.21 lbf ft)	-
5	Viti fissaggio coperchio motorino di avviamento a staffa di supporto	M5	2	6 Nm (4.43 lbf ft)	-
6	Vite fissaggio cover sensore pressione olio a motore	M5	1	6 Nm (4.43 lbf ft)	-

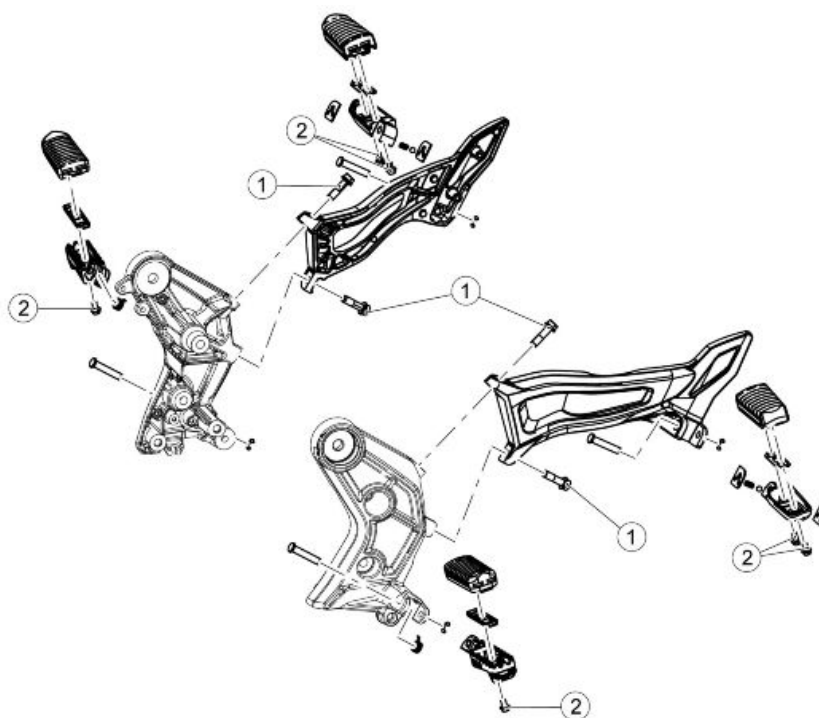
**PORTAPACCHI**

Pos.	Descrizione	Tipo	Quantità	Coppia	Note
1	Viti fissaggio copertura portapacchi a maniglione	M5	4	6 Nm (4.43 lbf ft)	-
2	Viti fissaggio maniglione a telaio	M8	4	25 Nm (18.44 lbf ft)	-

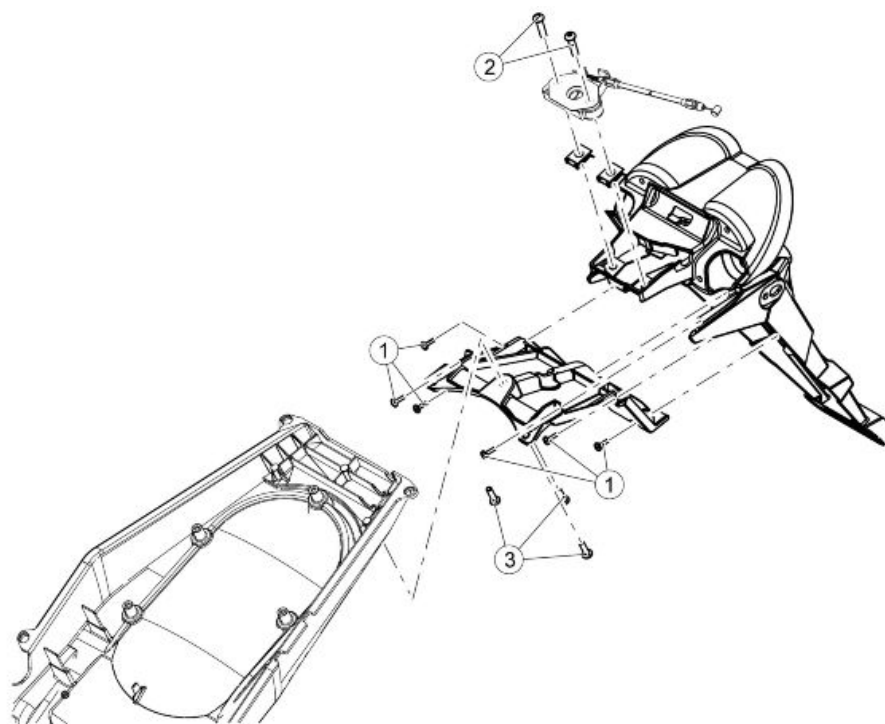


POMPA FRENO POSTERIORE

Pos.	Descrizione	Tipo	Quantità	Coppia	Note
1	Perno fissaggio aggancio molla leva freno posteriore a piastra telaio	-	1	6 Nm (4.43 lbf ft)	-
2	Vite fissaggio leva freno posteriore a piastra telaio	M8	1	25 Nm (18.44 lbf ft)	-
3	Dado fissaggio asta pompa freno posteriore a leva	M6	1	-	-
4	Vite fissaggio piolo	M6	1	10 Nm (7.38 lbf ft)	-
5	Viti fissaggio pompa freno posteriore e supporto serbatoio olio a piastra telaio	M6	2	10 Nm (7.38 lbf ft)	-
6	Vite fissaggio serbatoio olio e fermatappo a staffa supporto serbatoio olio	M6	1	6 Nm (4.43 lbf ft)	-
-	Perno fissaggio aggancio molla leva freno a leva freno posteriore completa	-	1	6 Nm (4.43 lbf ft)	-

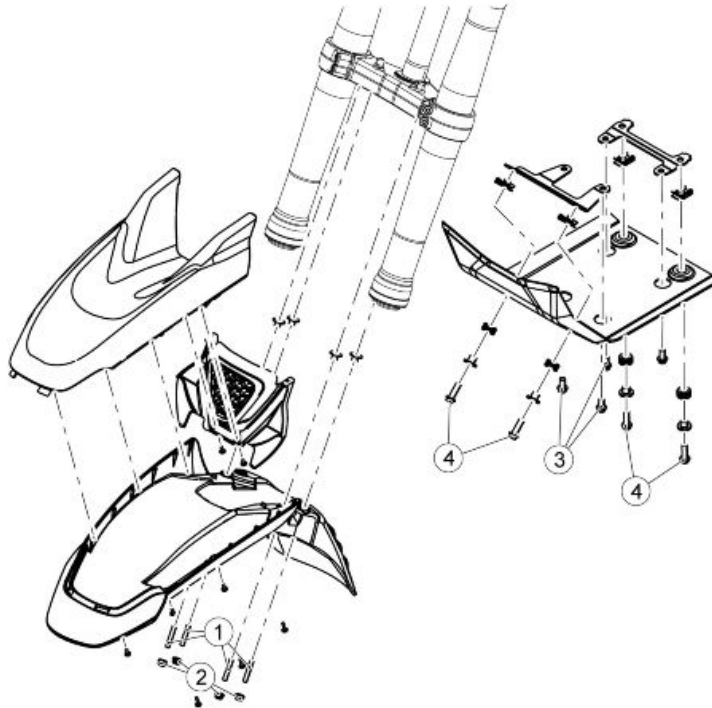
**PEDANE**

Pos.	Descrizione	Tipo	Quantità	Coppia	Note
1	Viti fissaggio supporti pedane passeggero a supporto telaio	M8	4	25 Nm (18.4 lbf ft)	-
2	Viti fissaggio gomma pedane a pedane	M6	6	10 Nm (7.38 lbf ft)	-
-	Viti fissaggio protezione paratacco passeggero a supporto pedana passeggero	M6	2	10 Nm (7.38 lbf ft)	-

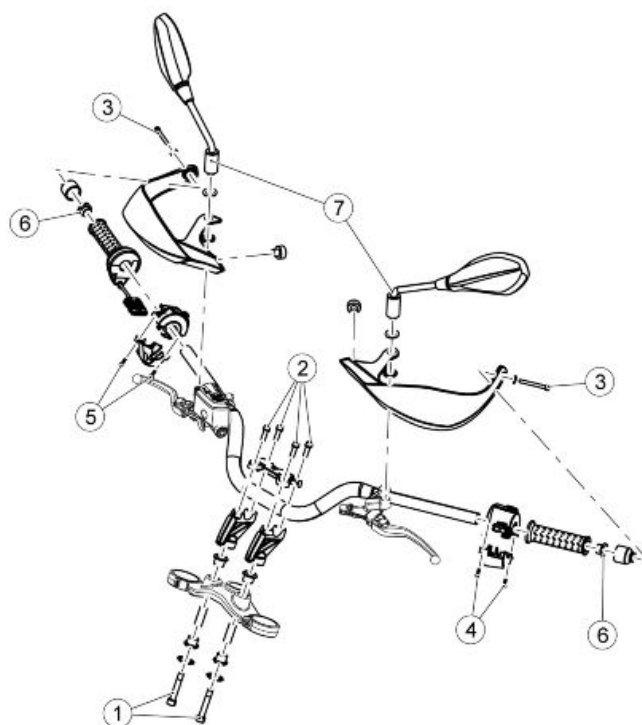


PARAFANGO POSTERIORE

Pos.	Descrizione	Tipo	Quantità	Coppia	Note
1	Viti fissaggio chiusura portatarga a portatarga	Autofilettante 3.9x14	6	3 Nm (2.21 lbf ft)	-
2	Viti fissaggio portatarga a telaio	M6	2	8 Nm (5.90 lbf ft)	-
3	Viti fissaggio portatarga a scatola batteria	Autofilettante 5x14	3	3 Nm (2.21 lbf ft)	-

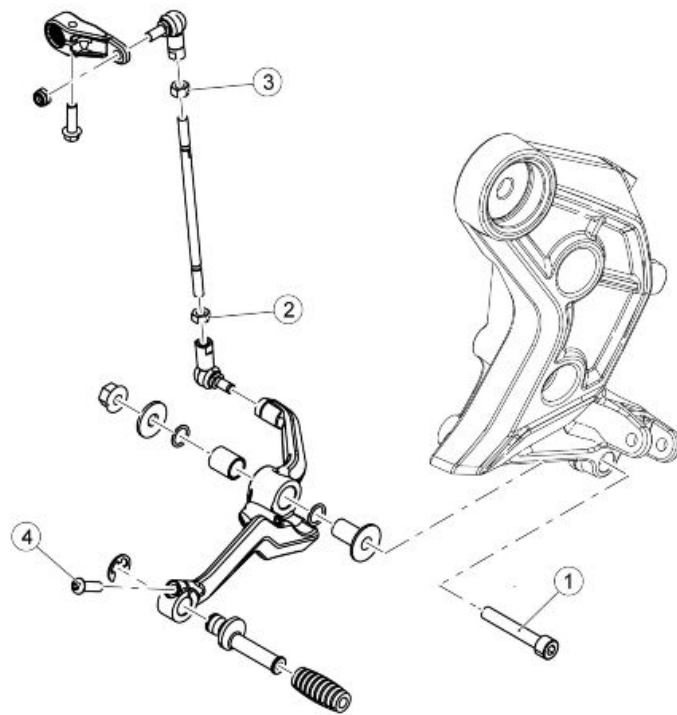
**PARAFANGO ANTERIORE - PUNTALE**

Pos.	Descrizione	Tipo	Quantità	Coppia	Note
1	Prigionieri fissaggio parafango anteriore a piastra inferiore di sterzo	M6	4	10 Nm (7.38 lbf ft)	-
2	Dadi fissaggio parafango anteriore a piastra inferiore di sterzo	M6	4	10 Nm (7.38 lbf ft)	-
3	Viti fissaggio staffe supporto paracoppa a motore	M8	4	20 Nm (14.75 lbf ft)	-
4	Viti fissaggio paracoppa a staffe supporto paracoppa	M8	4	20 Nm (14.78 lbf ft)	-



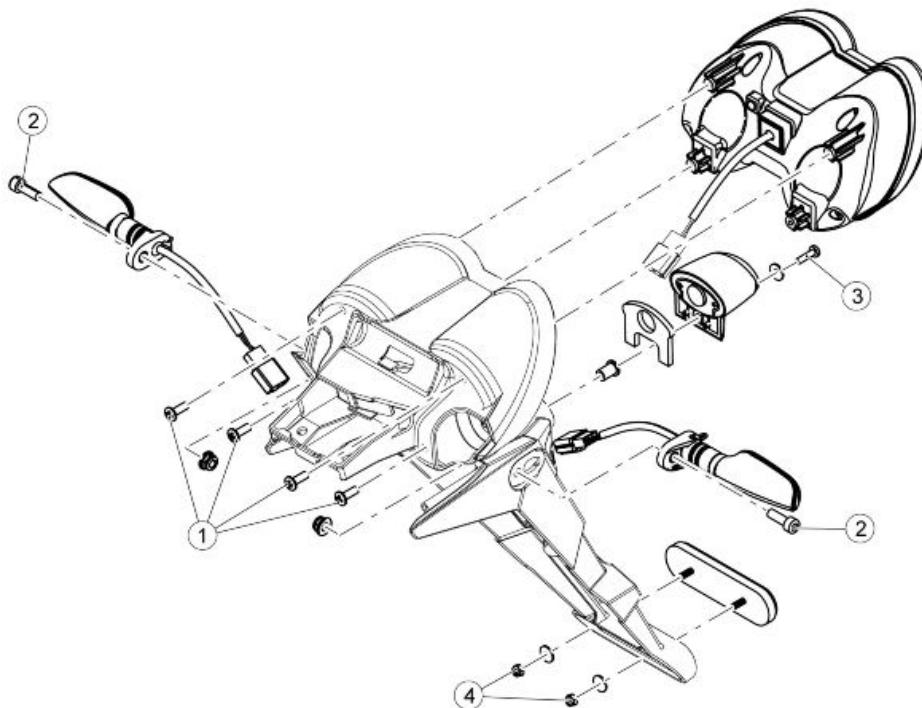
MANUBRIO - COMANDI

Pos.	Descrizione	Tipo	Quantità	Coppia	Note
1	Viti fissaggio cavallotti inferiori a piastra superiore di sterzo	M10	2	-	-
2	Viti fissaggio morsetto a cavallotti inferiori a manubrio	M8	4	-	-
3	Viti fissaggio paramani e pesi antivibranti a manubrio	M6	2	10 Nm (7.38 lbf ft)	-
4	Viti fissaggio guscio posteriore sinistro a blocchetto comando sinistro	M4	2	1.5 Nm (1.11 lbf ft)	Viti pre-montate sul guscio
5	Viti fissaggio guscio posteriore destro a blocchetto comando destro	M4	2	1.5 Nm (1.11 lbf ft)	Viti pre-montate sul guscio
6	Terminale fissaggio peso antivibrante a manubrio	-	2	10 Nm (7.38 lbf ft)	-
7	Fissaggio specchi retrovisori	-	2	Manuale	-
-	Viti fissaggio acceleratore comando elettronico a manubrio	M4	1	4 Nm (2.95 lbf ft)	Viti pre-montate sul comando gas



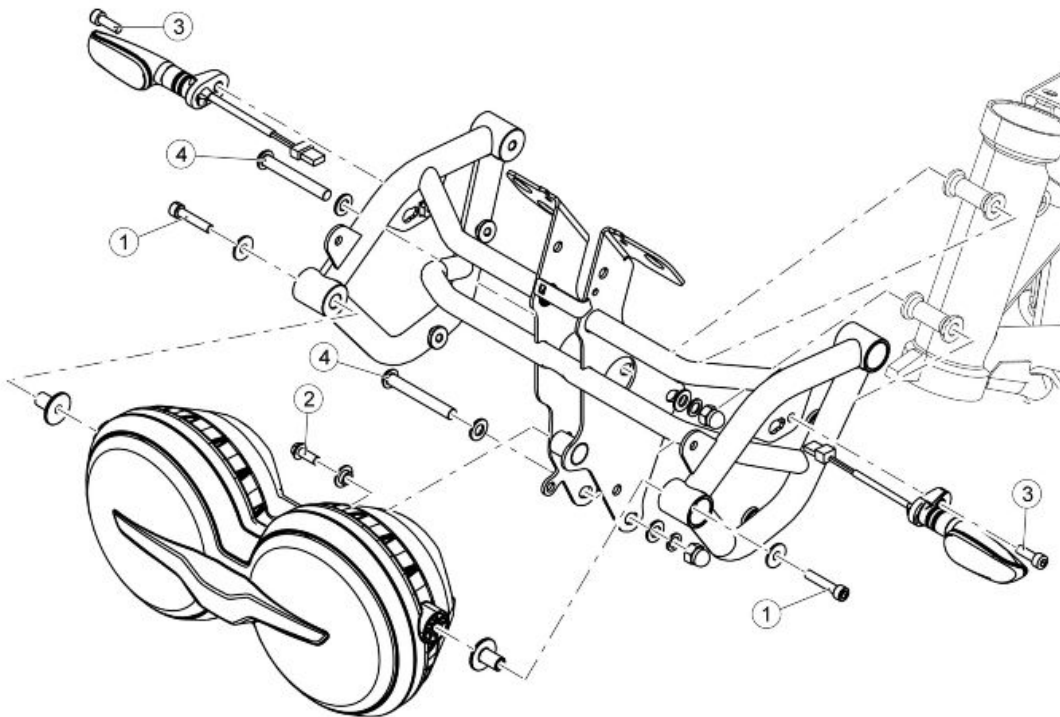
LEVA CAMBIO

Pos.	Descrizione	Tipo	Quantità	Coppia	Note
1	Vite fissaggio leva cambio a piastra sinistra telaio	M8	1	25 Nm (18.44 lbf ft)	-
2	Dado fissaggio tirante comando cambio a leva cambio	M6	1	-	Manuale con dima
3	Dado fissaggio tirante comando cambio a leva preselettore	M6	1	-	Manuale con dima
4	Vite fissaggio piolo	M6	1	10 Nm (7.38 lbf ft)	-

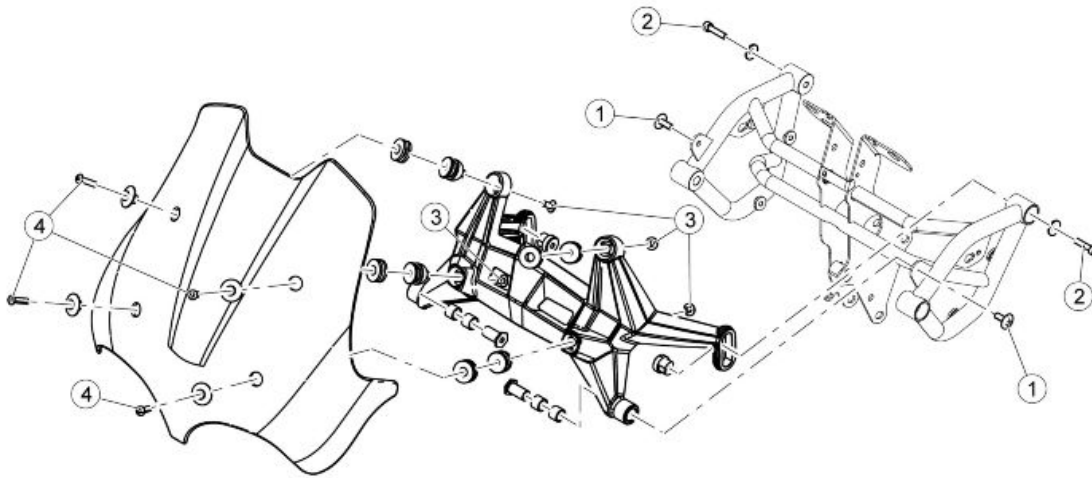


FANALE POSTERIORE

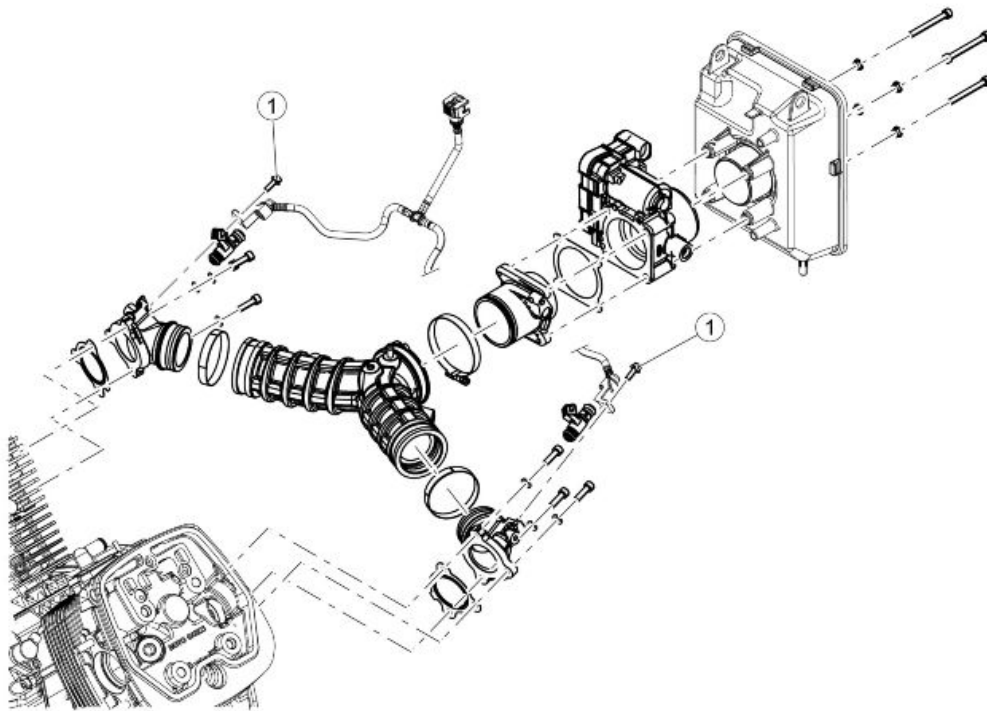
Pos.	Descrizione	Tipo	Quantità	Coppia	Note
1	Viti fissaggio fanale posteriore a portatarga	Autofilettante 5x14	4	3 Nm (2.21 lbf ft)	-
2	Viti fissaggio indicatori di direzione posteriore a portatarga	M6	2	3 Nm (2.21 lbf ft)	Con dado autobloccante
3	Viti fissaggio luce targa a portatarga	M4	1	3 Nm (2.21 lbf ft)	-
4	Dadi fissaggio catadiottro posteriore a portatarga	M4	2	4 Nm (2.95 lbf ft)	-

**FANALERIA ANTERIORE**

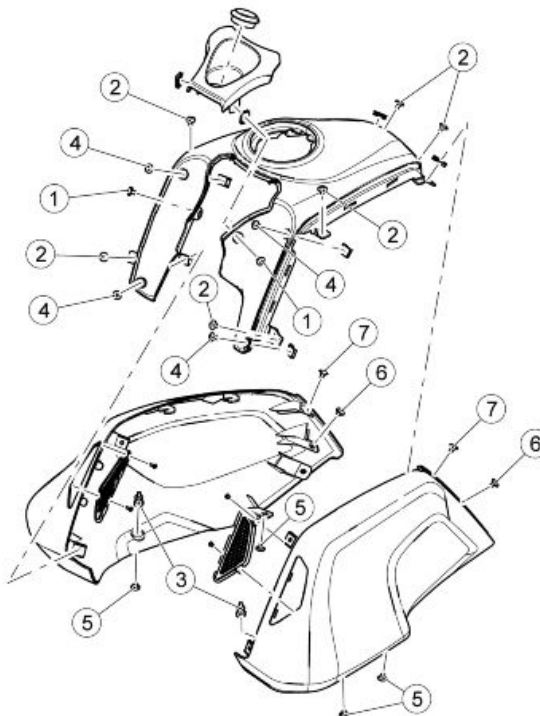
Pos.	Descrizione	Tipo	Quantità	Coppia	Note
1	Viti fissaggio superiore proiettore anteriore a telaietto anteriore	M6	2	10 Nm (7.38 lbf ft)	-
2	Vite fissaggio inferiore proiettore anteriore a telaietto anteriore	M6	1	10 Nm (7.38 lbf ft)	-
3	Viti fissaggio indicatori di direzione anteriore a telaietto anteriore	M6	2	8 Nm (5.90 lbf ft)	-
4	Viti fissaggio telaietto anteriore a canotto	M8	2	25 Nm (18.44 lbf ft)	Con dado cieco

**CUPOLINO-PARABREZZA**

Pos.	Descrizione	Tipo	Quantità	Coppia	Note
1	Viti fissaggio anteriore supporto parabrezza a telaio anteriore	M6	2	10 Nm (7.38 lbf ft)	-
2	Viti fissaggio posteriore supporto parabrezza a telaio anteriore	M6	2	10 Nm (7.38 lbf ft)	-
3	Viti fissaggio bussole supporto parabrezza a supporto parabrezza	M6	4	10 Nm (7.38 lbf ft)	-
4	Viti fissaggio parabrezza a supporto parabrezza	M6	4	10 Nm (7.38 lbf ft)	-

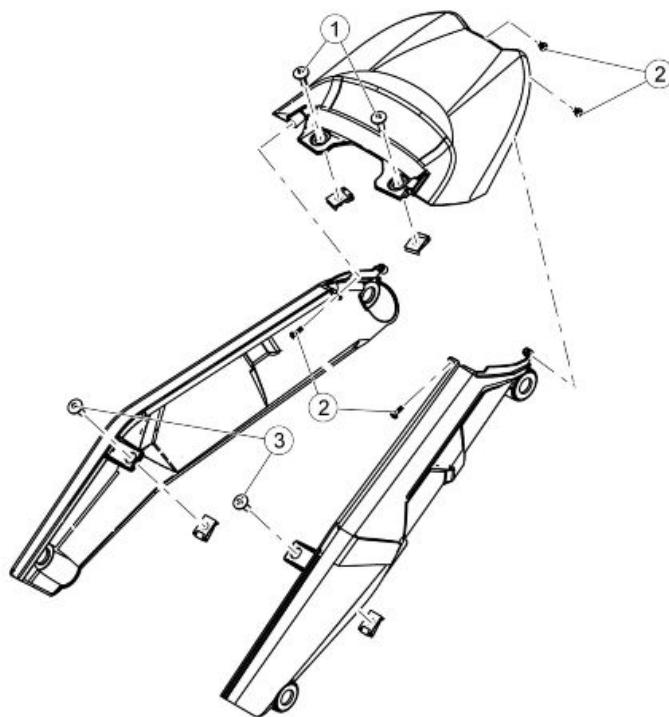
**CORPO FARFALLATO**

Pos.	Descrizione	Tipo	Quantità	Coppia	Note
1	Viti fissaggio cappucci iniettori a raccordi di ammissione	-	2	6 Nm (4.43 lbf ft)	-

**COPRISERBATOIO**

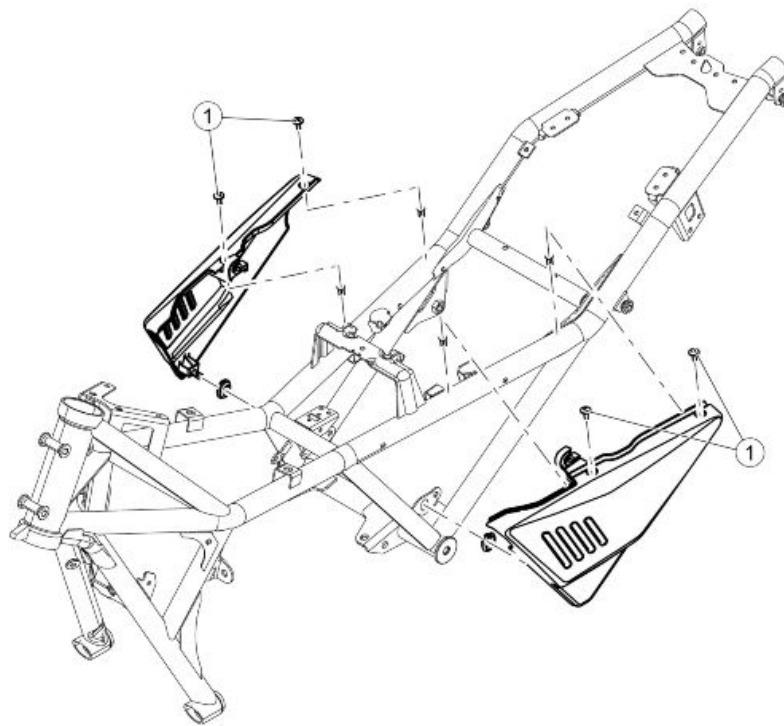
Pos.	Descrizione	Tipo	Quantità	Coppia	Note
1	Viti fissaggio cover blocchetto accensione a cover tappo serbatoio	M5	2	4 Nm (2.95 lbf ft)	-

Pos.	Descrizione	Tipo	Quantità	Coppia	Note
2	Viti fissaggio cover tappo serbatoio a serbatoio carburante	M5	6	4 Nm (2.95 lbf ft)	-
3	Colonnette fissaggio supporto cover serbatoio laterali a serbatoio carburante	-	2	4 Nm (2.95 lbf ft)	-
4	Viti fissaggio anteriore cover serbatoio a cover tappo carburante	M5	4	4 Nm (2.95 lbf ft)	-
5	Viti fissaggio inferiore cover serbatoio laterali a serbatoio carburante	M5	4	4 Nm (2.95 lbf ft)	-
6	Viti fissaggio posteriore cover serbatoio a serbatoio carburante	M5	2	4 Nm (2.95 lbf ft)	-
7	Viti fissaggio posteriore cover serbatoio a cover tappo serbatoio	M5	2	4 Nm (2.95 lbf ft)	-



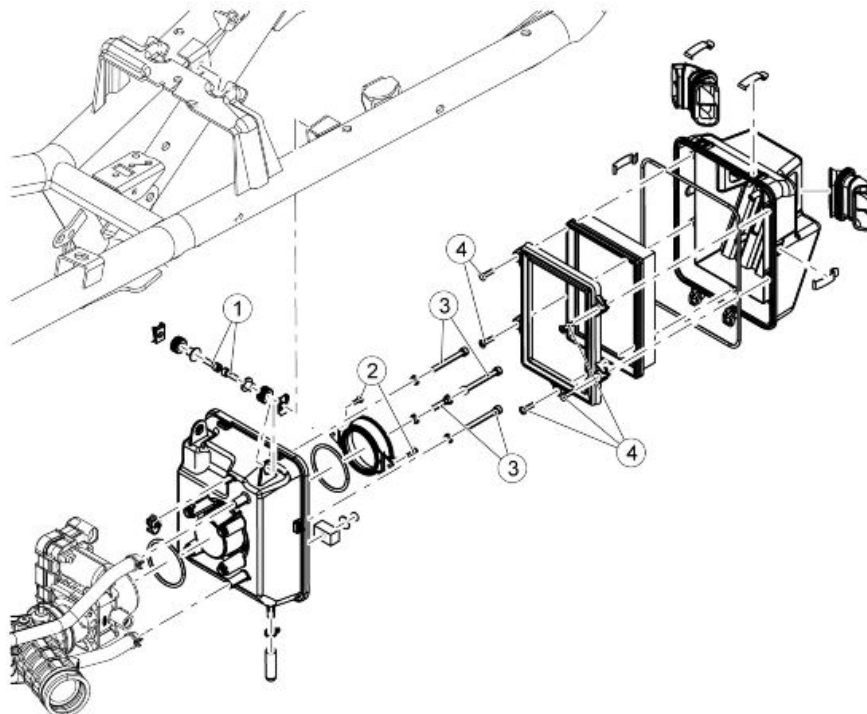
CARROZZERIA POSTERIORE

Pos.	Descrizione	Tipo	Quantità	Coppia	Note
1	Vite fissaggio copertura posteriore	M5	2	6 Nm (4.43 lbf ft)	-
2	Vite fissaggio copertura posteriore centrale a coperture posteriori laterali	Autofilettante 3.5x10	4	2 Nm (1.48 lbf ft)	-
3	Viti fissaggio coperture posteriori laterali destra e sinistra a telaio	M5	2	6 Nm (4.43 lbf ft)	-



CARROZZERIA CENTRALE

Pos.	Descrizione	Tipo	Quantità	Coppia	Note
1	Viti fissaggio fianchetti a telaio	M5	4	6 Nm (4.43 lbf ft)	-



CASSA FILTRO

Pos.	Descrizione	Tipo	Quantità	Coppia	Note
1	Viti fissaggio cassa filtro a telaio	M6	2	10 Nm (7.38 lbf ft)	-

Pos.	Descrizione	Tipo	Quantità	Coppia	Note
2	Viti fissaggio trombetta di aspirazione a coperchio cassa filtro	TCB 4.2x16	2	3 Nm (2.21 lbf ft)	-
3	Viti fissaggio corpo farfallato a coperchio cassa filtro	M6	4	10 Nm (7.38 lbf ft)	-
4	Viti fissaggio filtro aria a scatola filtro	M5	5	3 Nm (2.21 lbf ft)	-

Side fairings

REMOVAL

The following procedure is described for a single side bumper, but is valid for both side bumpers.

- Undo and remove the screw (1)



- Remove the side bumpers (2)



Rear rack

LUGGAGE RACK COVER REMOVAL

- Holding the nuts still located on the lower part of the area indicated in the figure, loosen and remove the screws (1)



- Remove the luggage rack cover (2)



LUGGAGE RACK REMOVAL

- Unscrew and remove the screws (1)



- Unscrew and remove the screws (2)



- Remove the luggage rack (3)



Hand guards

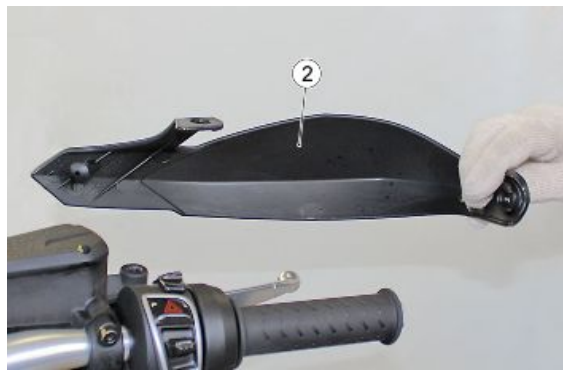
REMOVAL

The following procedure is described for a single handguard, but is valid for both handguards.

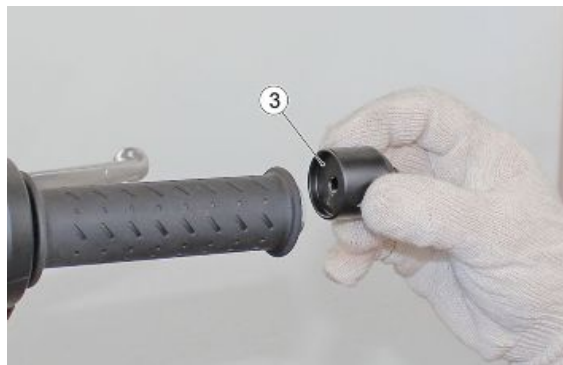
- Remove the rear view mirrors
- Undo and remove the screw (1)



- Remove the handguards (2)



- Retrieve the counterweight (3)



Driving mirrors

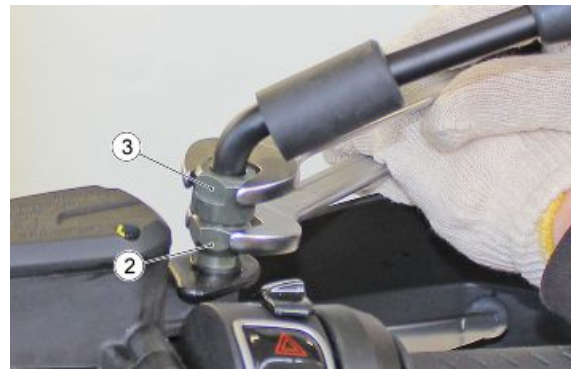
REMOVAL

The following procedure is described for a single rear view mirror, but is valid for both mirrors.

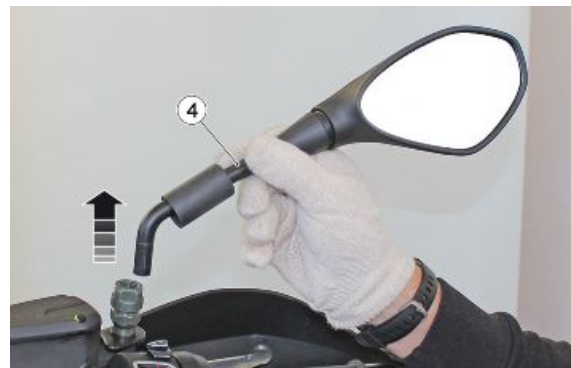
- Remove the rubber piece (1)



- Holding the locknut (2) so it cannot rotate, loosen the nut (3)



- Remove the rear view mirror (4)



- Undo and remove the locknut (2)



Instrument panel

REMOVAL

- Remove the headlight
- Unscrew and remove the screws (1)



- Disconnect the connector (2)



- Remove the instrument panel (3)



Headlight assy.

REMOVAL

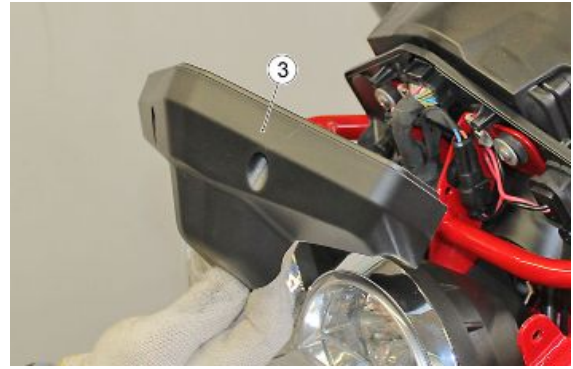
- Remove the top fairing
- Unscrew and remove the screws (1)



- Unscrew and remove the screws (2)



- Remove the cover (3).



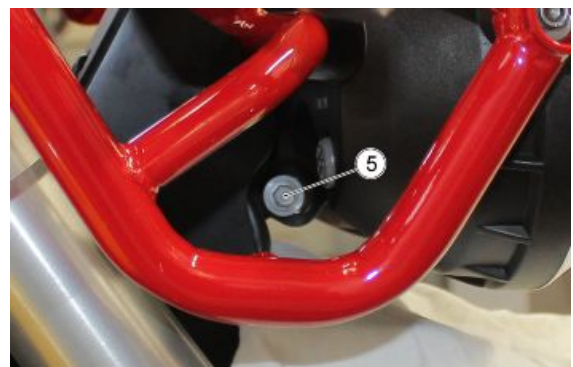
- Remove the connector (4) from the support as indicated in the figure



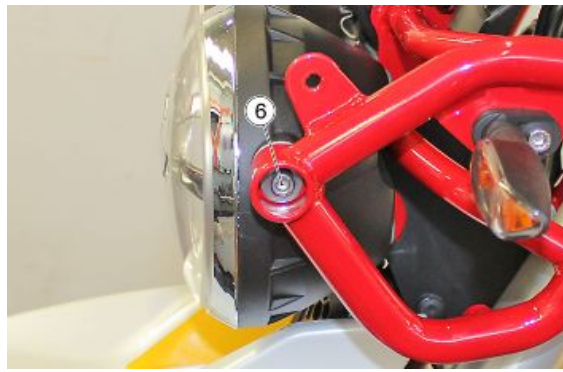
- Disconnect the connector (4)



- Undo and remove the screw (5)



- Undo and remove the screw (6)



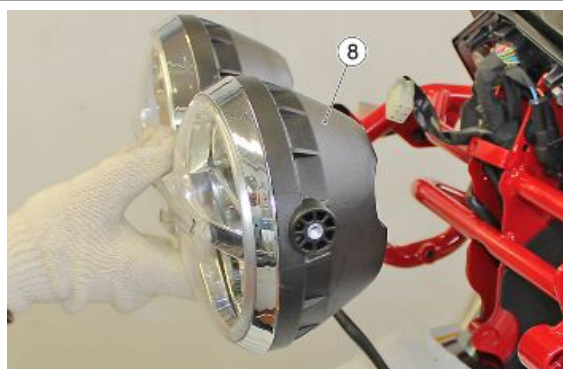
- Undo and remove the screw (7)



- Remove the wiring as indicated in the figure



- Remove the front light assembly (8)



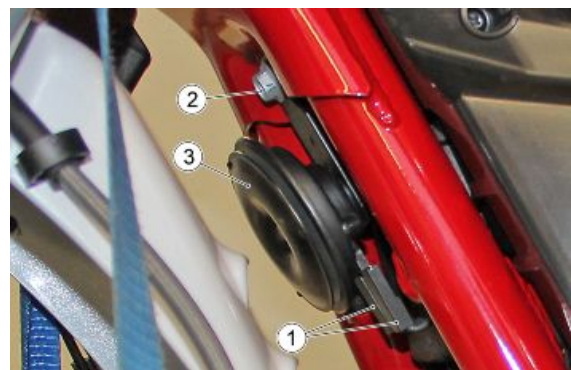
- Retrieve the bushings (9)



Horn

REMOVAL

- Disconnect the connectors (1)
- Undo and remove the screw (2)
- Remove the horn (3)



Turn indicators

REMOVING FRONT TURN INDICATORS

- Remove the top fairing
- Disconnect the left turn indicator connector (1)



- Disconnect the right turn indicator connector (2)



- Unscrew and remove the screws (3) from both sides of the vehicle

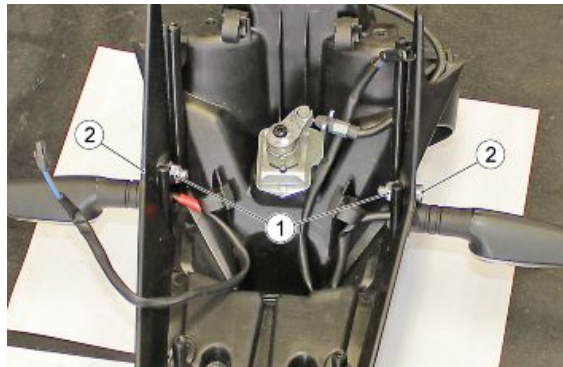


- Remove the front turn indicators (4) from both sides of the vehicle

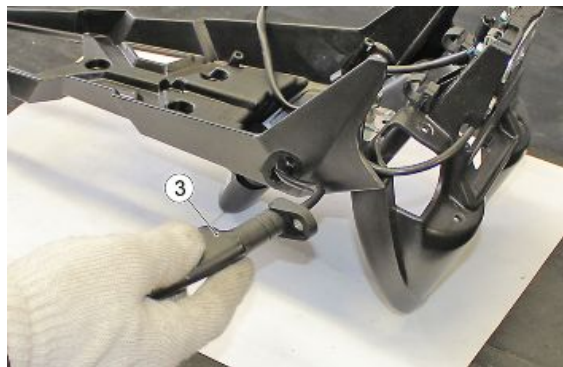


REAR TURN INDICATORS REMOVAL

- Block the nuts (1) so that they cannot rotate and unscrew and remove the screws (2)



- Remove the rear turn indicators (3)



Headlight fairing

REMOVAL

- Unscrew and remove the screws (1)



- Remove the top fairing (2)



TOP FAIRING BRACKET REMOVAL

- Unscrew and remove the screws (1)



- Unscrew and remove the screws (2)



- Remove the support (3)



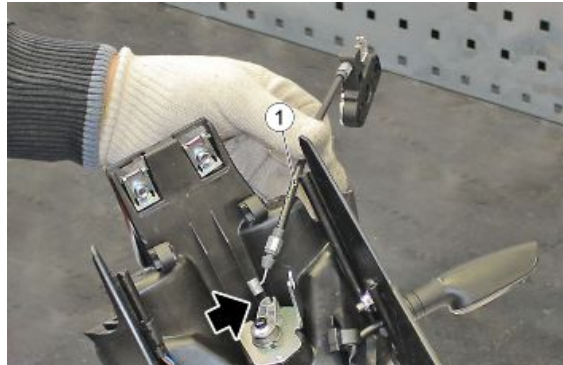
Disassembling the lock

REMOVAL

- Remove the licence plate holder bracket
- Unhook and remove the wire (1) from its seat



- Remove the wire (1) from the point indicated in the figure



- Remove the plate (2)

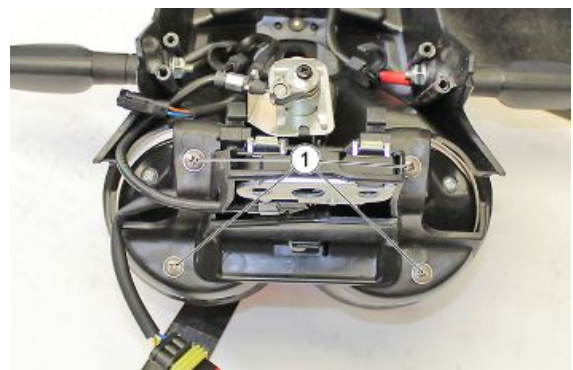


- Remove the saddle lock (3)

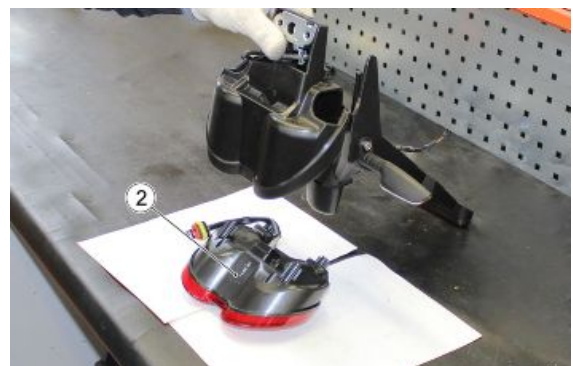


Taillight assy.

- Remove the licence plate holder bracket
- Unscrew and remove the screws (1)



- Remove the rear light assembly (2)



License plate light

REMOVAL

- Remove the licence plate holder bracket
- Undo and remove the screw (1)



- Remove the licence plate light (2)



Footrest

REMOVING THE PASSENGER FOOTRESTS

The following procedure is described for a single footrest, but is valid for both passenger footrests.

- Remove the snap ring(1)



- Remove the pin (2)



- Remove the passenger footrest (3)



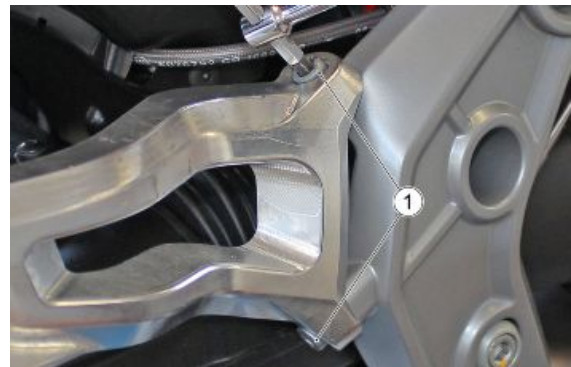
- Retrieve the two plates (4), the sphere (5) and the spring (6)



REMOVING THE PASSENGER FOOTREST SUPPORT

The following procedure is described for a single bracket, but is valid for both passenger footrest brackets.

- Unscrew and remove the two screws (1)



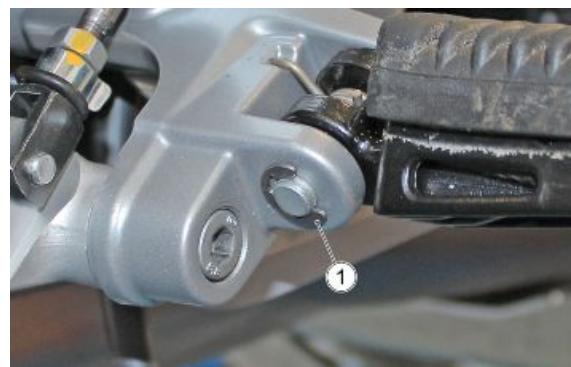
- Remove the passenger footrest bracket (2)



RIDER FOOTREST REMOVAL

The following procedure is described for a single footrest, but is valid for both rider footrests.

- Remove the snap ring (1)



- Remove the pin (2)



- Remove the rider footrest (3)

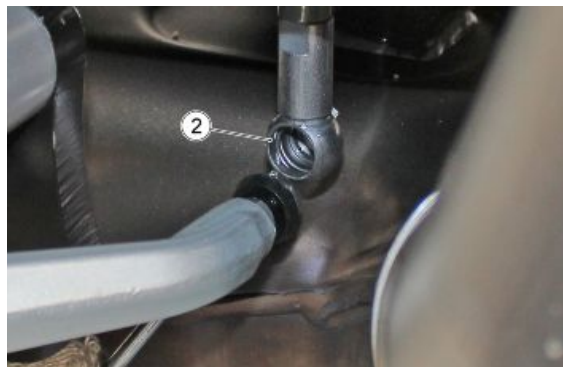


REMOVING THE GEAR SHIFT LEVER

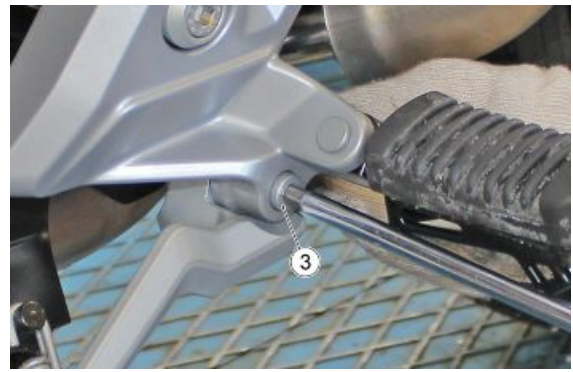
- Remove the safety clip (1) from the gear shift lever



- Remove the gear shift lever from the spherical joint (2)



- Undo and remove the screw (3)



- Remove the gear lever (4)

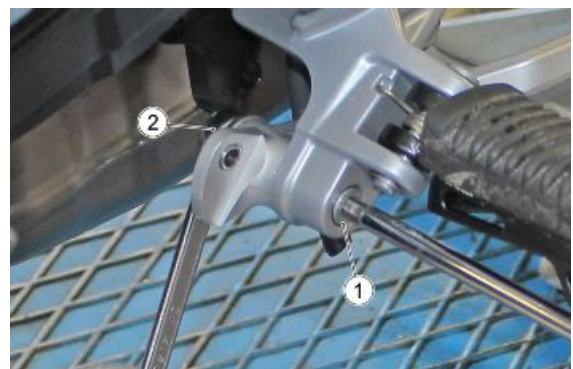


- Retrieve the bushing (5) and the two O-rings (6)



REMOVING THE REAR BRAKE LEVER

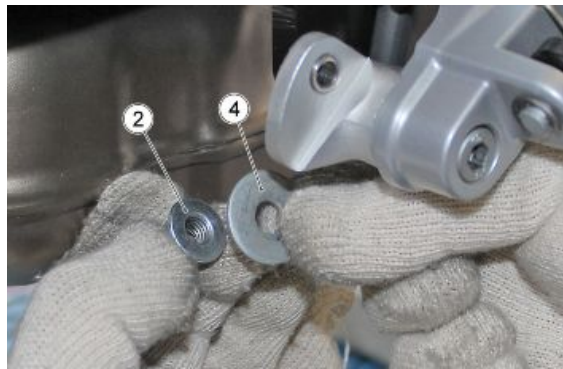
- Holding the nut (2) so that it cannot rotate, remove the screw (1)



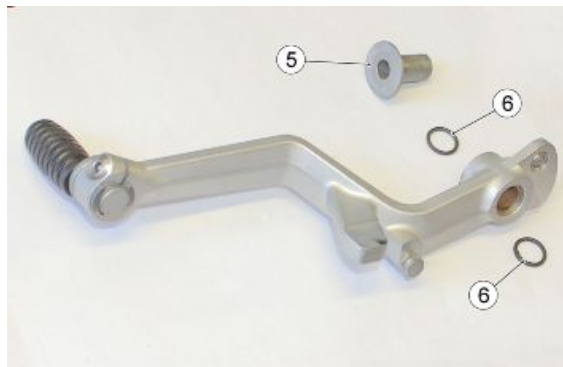
- Remove the rear brake lever (3)



- Retrieve the nut (2) and the washer (4)



- Retrieve the bushing (5) and the two O-rings (6)

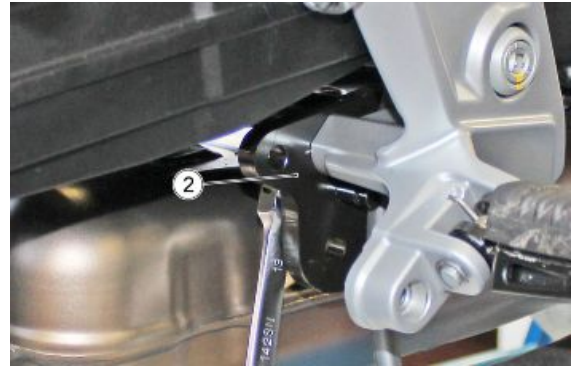


RIGHT RIDER FOOTREST BRACKET REMOVAL

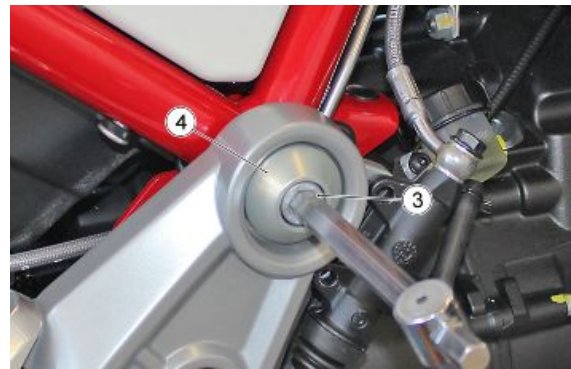
- Remove the rear brake master cylinder, brake master cylinder plunger and front brake lever
- Undo and remove the screw (1)



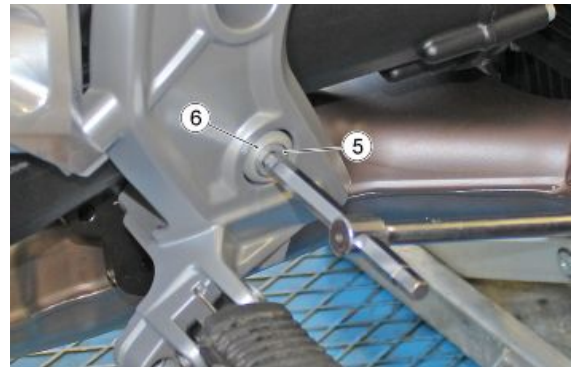
- Undo and remove the screw (2)



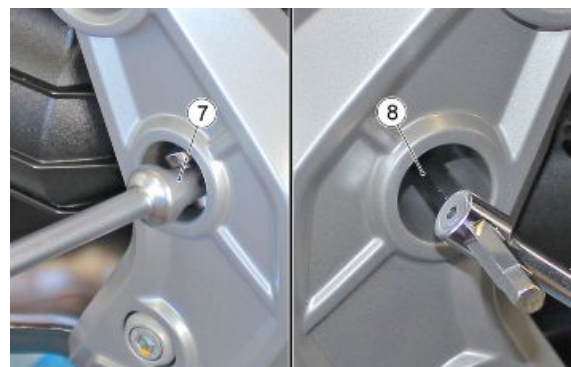
- Undo and remove the screw (3)
- Retrieve the bushing (4)



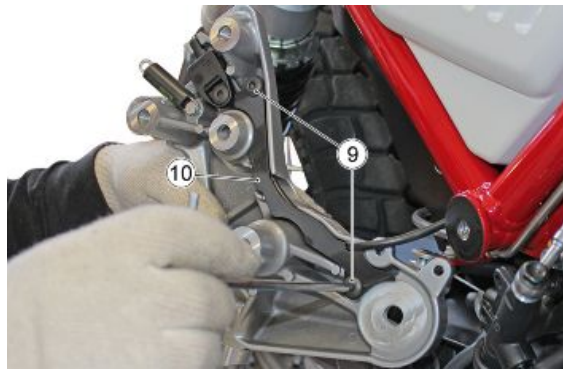
- Undo and remove the screw (5)
- Retrieve the bushing (6)



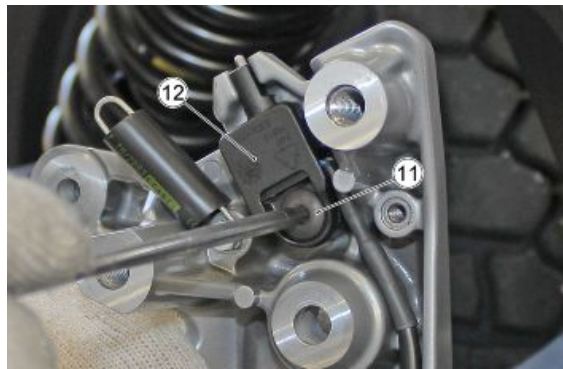
- Hold the nut (7) from the opposite side so that it cannot rotate and remove the screw (8)



- Rotate the plate 180°, undo and remove the screws (9) and remove the bracket (10)



- Undo and remove the screw (11) and remove the sensor (12) from the bracket



- Remove the right rider footrest bracket plate (13)
- Remove the passenger footrest bracket

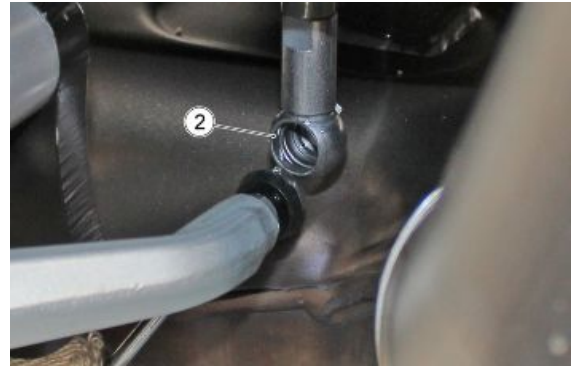


LEFT RIDER FOOTREST BRACKET REMOVAL

- Remove the safety clip (1)



- Remove the gear shift lever from the spherical joint (2)



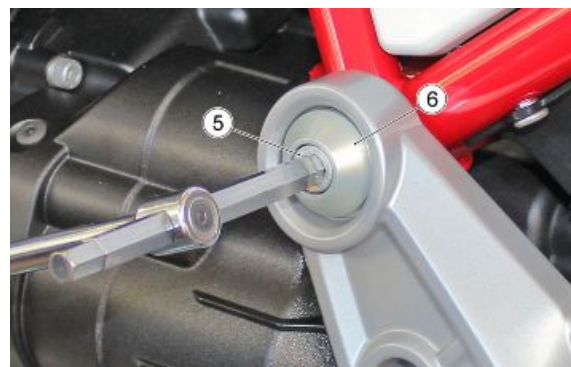
- Undo and remove the screw (3)



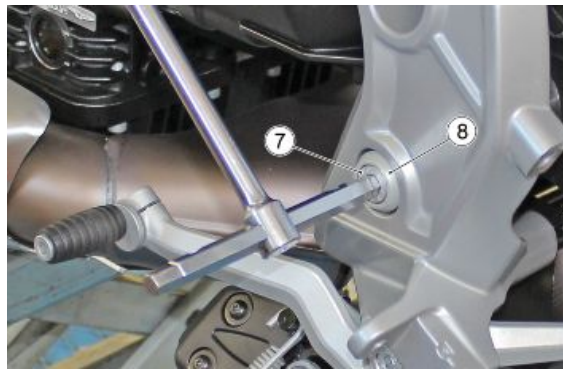
- Undo and remove the screw (4)



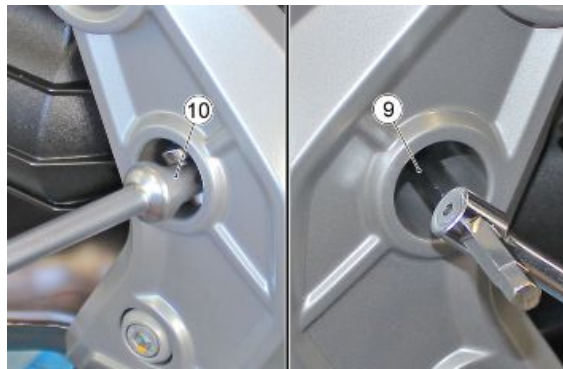
- Undo and remove the screw (5) and retrieve the bushing (6)



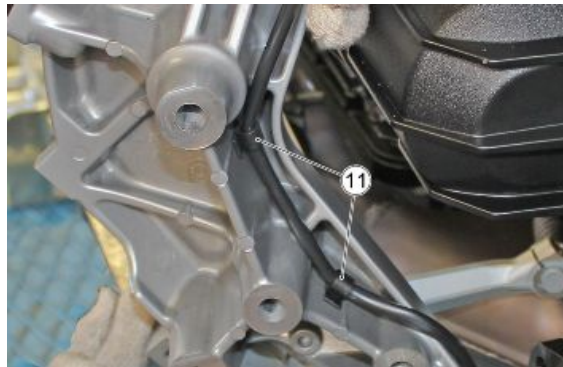
- Undo and remove the screw (7) and retrieve the bushing (8)



- Holding the screw (9) from the opposite side so that it cannot rotate, undo and remove the nut (10)



- Rotate the plate 180° and remove the two cable grommets (11)



- Remove the left rider footrest bracket plate (12)



Side body panels

REMOVAL

The following procedure is described for a single side panel, but is valid for both side panels.

- Remove the glove compartment
- Unscrew and remove the screws (1)



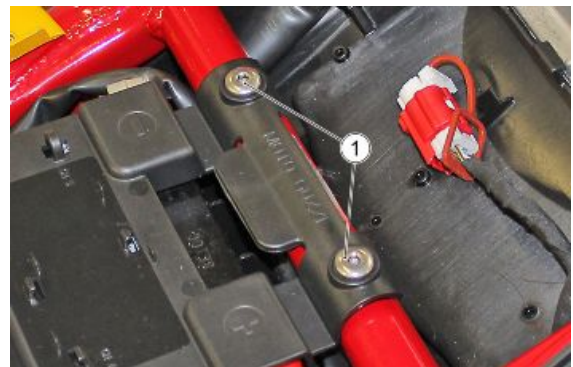
- Remove the side fairing panel (2)



Glove-box

REMOVAL

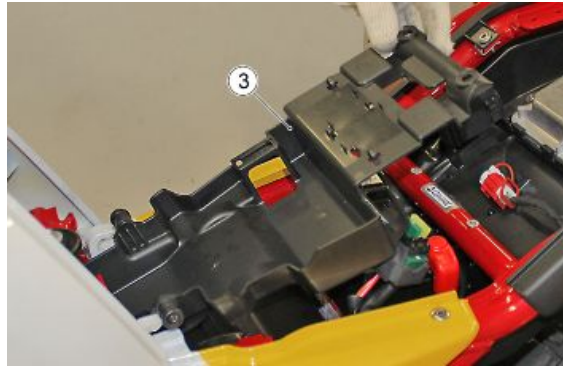
- Remove the saddle
- Unscrew and remove the screws (1)



- Remove the fuses (2) from the support indicated in the figure



- Remove the glove compartment (3)



Side fairings

REMOVAL

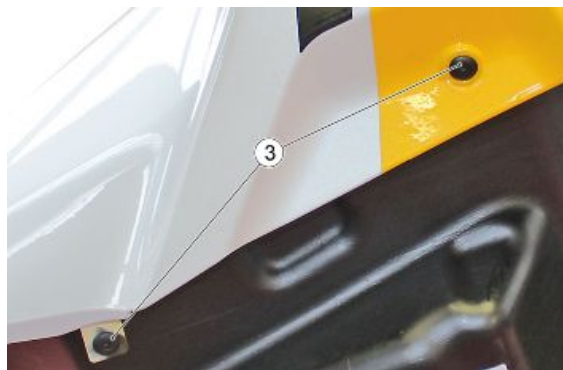
- Remove the fuel tank
- Unscrew and remove the screws (1)



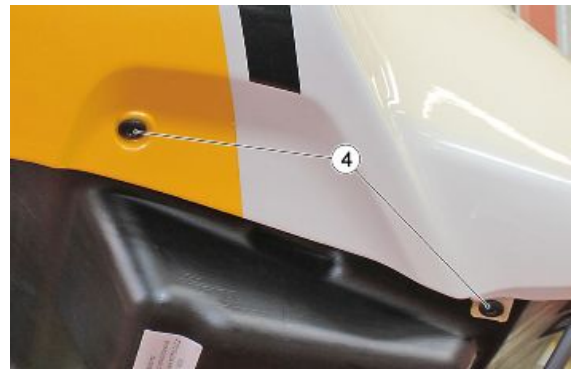
- Unscrew and remove the screws (2)



- Unscrew and remove the screws (3)



- Unscrew and remove the screws (4)



- Remove the left side engine fairing (5)



- Remove the right side engine fairing (6)



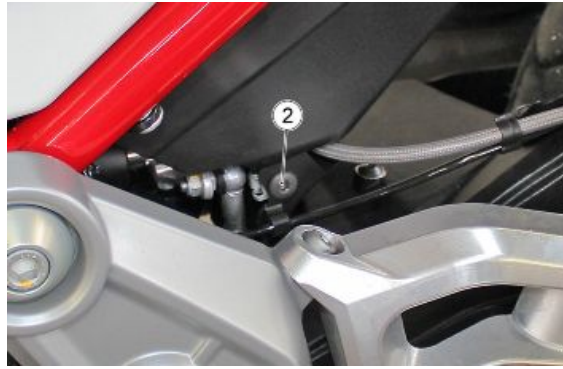
Fairing mounting panels

REAR BRAKE HOSE GUIDE REMOVAL

- Undo and remove the screw (1)



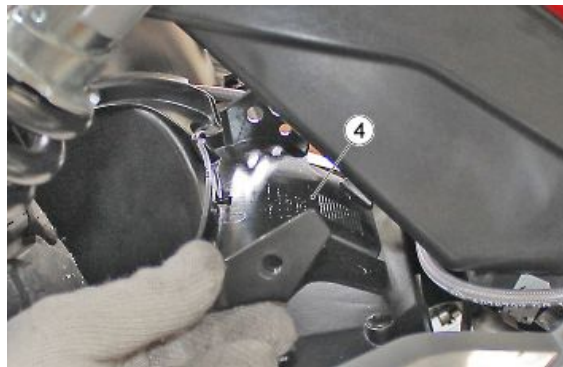
- Undo and remove the screw (2)



- Remove the cable grommet (3)



- Remove the rear brake hose guide (4)



UNDER-SADDLE COMPARTMENT/BATTERY BOX REMOVAL

- Remove the side fairing panels
- Remove the licence plate holder bracket
- Remove the fuse box (1)



- Unscrew and remove the screws (2)



- Unscrew and remove the screws (3)



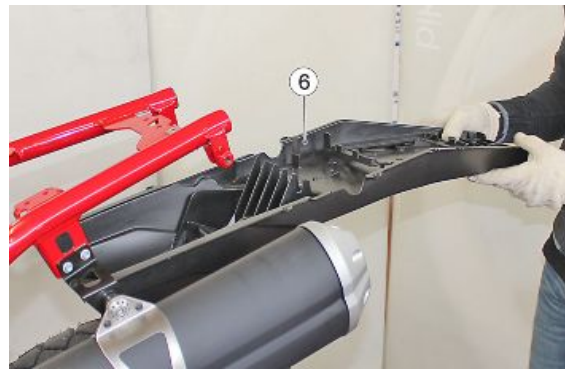
- Unscrew and remove the screws (4)



- Unscrew and remove the screws (5)



- Remove the under-saddle compartment/battery box (6)



License plate holder

LICENCE PLATE HOLDER BRACKET REMOVAL

- Remove the luggage rack
- Unscrew and remove the screws (1)



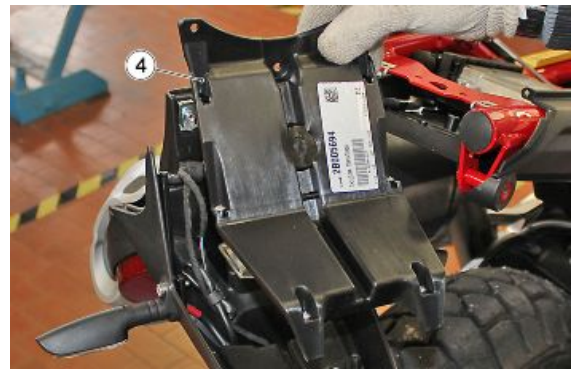
- Unscrew and remove the screws (2)



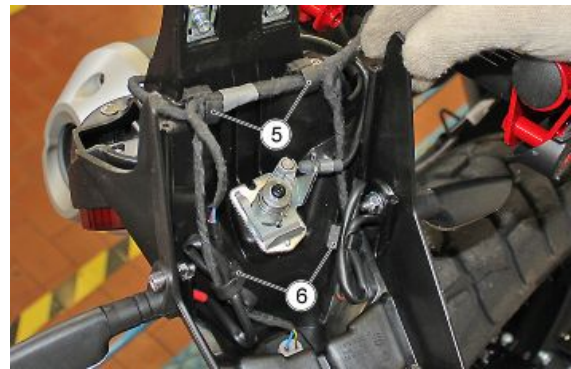
- Support the licence plate bracket
- Unscrew and remove the screws (3)



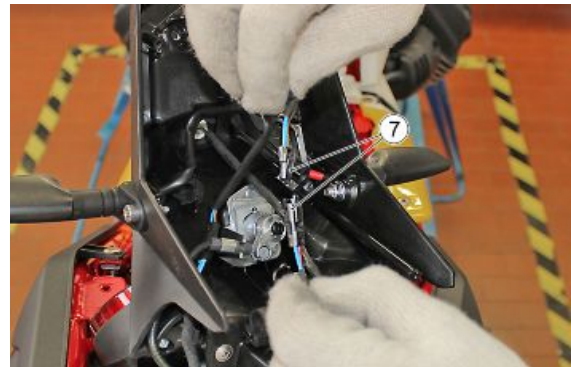
- Remove the licence plate bracket cover (4)



- Remove the wiring from the cable glands (5)
- Remove the wiring from the cable glands (6)



- Disconnect the right turn indicator connector (7)



- Disconnect the left turn indicator connector (8)



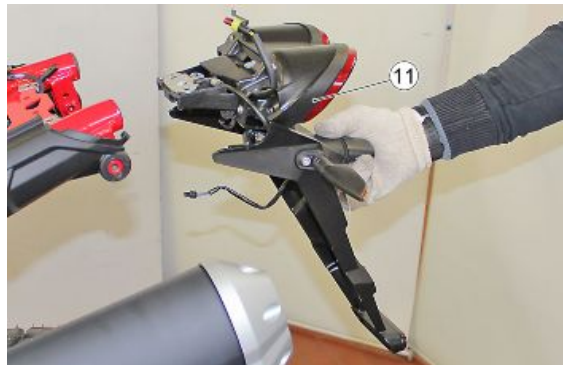
- Disconnect the connector (9)



- Remove the licence plate light (10)



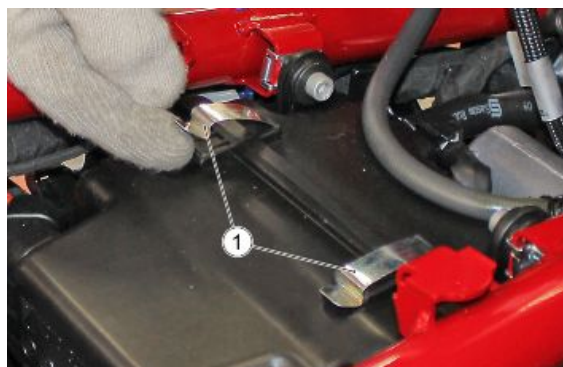
- Remove the licence plate holder (11) complete with rear light assembly and rear turn indicators
- Remove the rear light cluster
- Remove the rear turn indicators



Air box

REMOVAL

- Remove the saddle
- Remove the glove compartment
- Remove the side fairing panels
- Unhook and remove the four springs (1) located around the airbox filter, two in the upper area, one on the left side and one on the right side



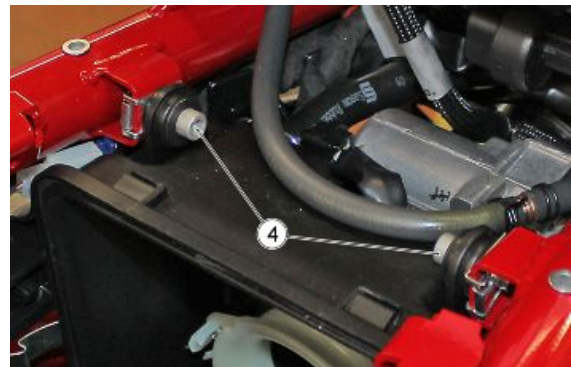
- Remove the filter box (2)



- Unscrew the screws (3)



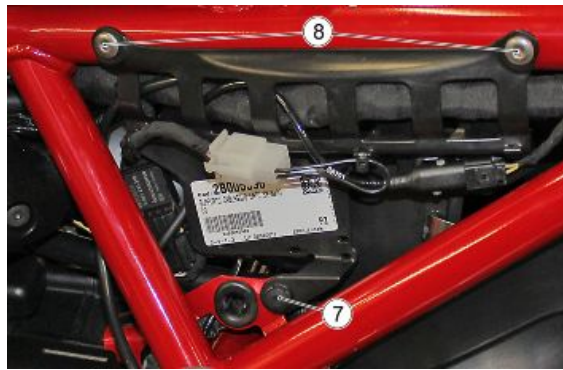
- Unscrew and remove the screws (4)



- Loosen the clamp (5)
- Disconnect the pipe (6)



- Remove the plastic rivet (7)
- Unscrew and remove the screws (8)



- Disconnect the connector (9)
- Momentarily remove the support bracket (10) from the frame



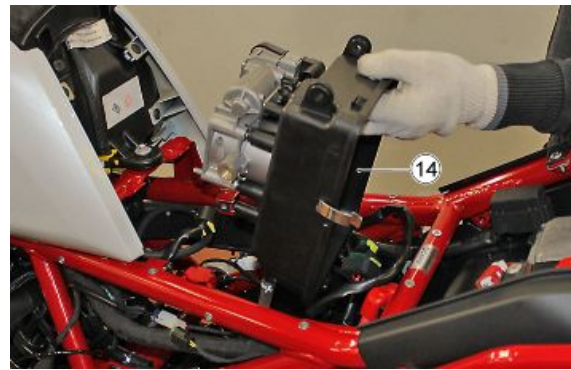
- Loosen the clamp (11)
- Disconnect the pipe (12)



- Disconnect the connector (13)



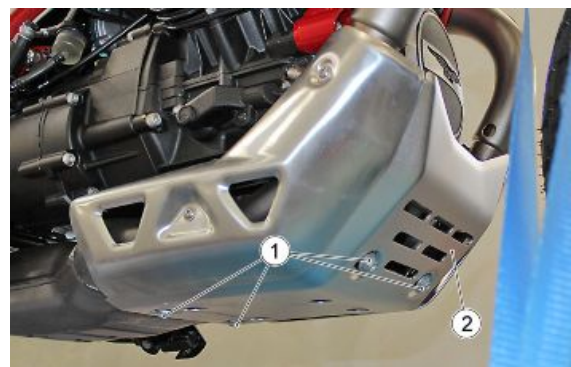
- Remove the filter box cover (14) complete with throttle body
- Slide the throttle body out and remove it



Sump guard

REMOVAL

- Unscrew and remove the screws (1)
- Remove the sump guard (2)



Fuel tank

- Remove the ignition switch assembly gasket (1)



- Undo and remove the screw (2)



- Undo and remove the screw (3)



- Remove the ignition switch assembly cover (4)



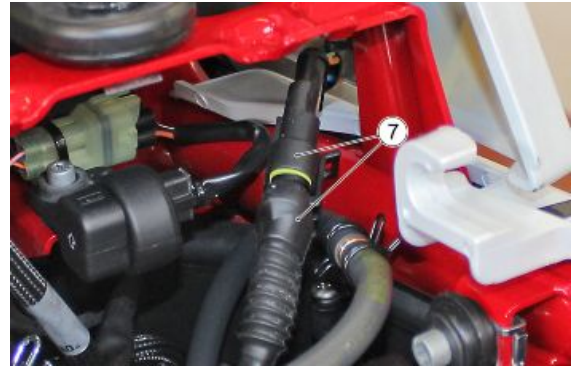
- Unscrew and remove the screws (5)



- Undo and remove the screw (6)



- Disconnect the connector (7)



- Disconnect the fuel pump hose (8)



- Loosen the clamp (9) and disconnect the hose (10)



- Lifting the front part of the fuel tank, loosen the clamp (11) and disconnect the hose (12)



- Remove the fuel tank (13)



TANK FILLER CAP REMOVAL

- Open the tank filler cap
- Unscrew and remove the screws (1)



- Remove the tank filler cap (2)

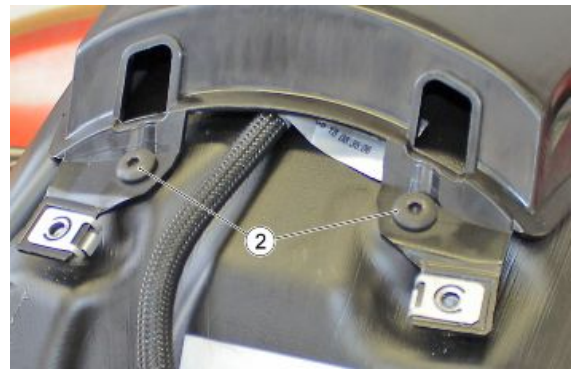


CENTRAL TANK FAIRING REMOVAL

- Undo and remove the screw (1)



- Unscrew and remove the screws (2)



- Undo and remove the screw (3)



- Unscrew and remove the screws (4)



- Remove the central tank fairing (5)



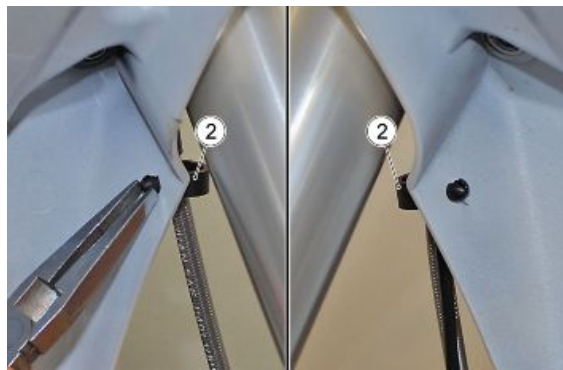
Front mudguard

REMOVAL

- Unscrew and remove the nuts (1)



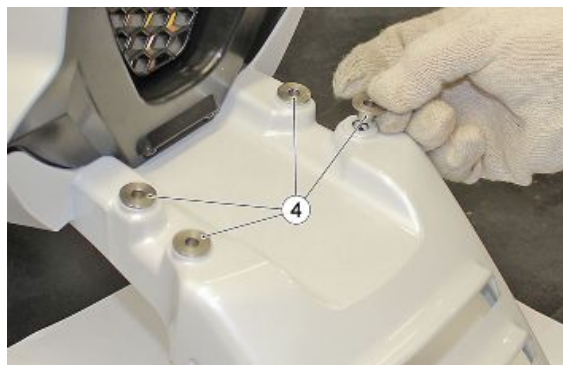
- Remove the cable grommets from both sides of the mudguard (2)



- Remove the complete front mudguard (3)



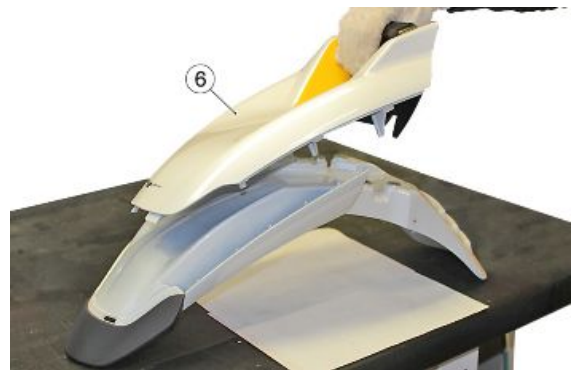
- Retrieve the bushings (4)



- Unscrew and remove the screws (5)



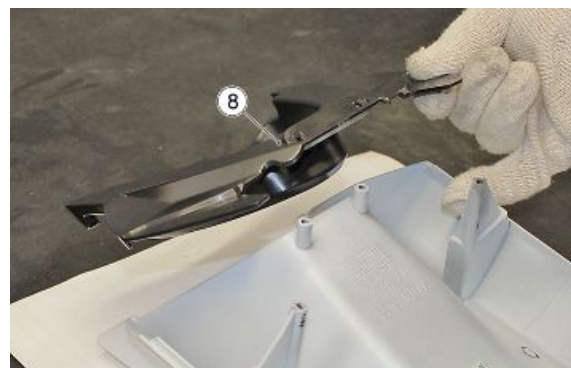
- Remove the mudguard cover (6)



- Undo and remove the screws (7)



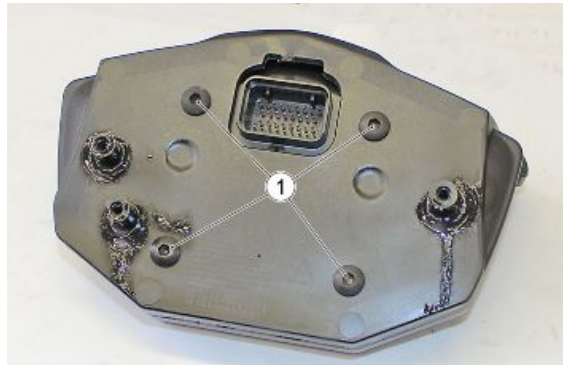
- Remove the grille (8)



Instrument cluster support

REMOVAL

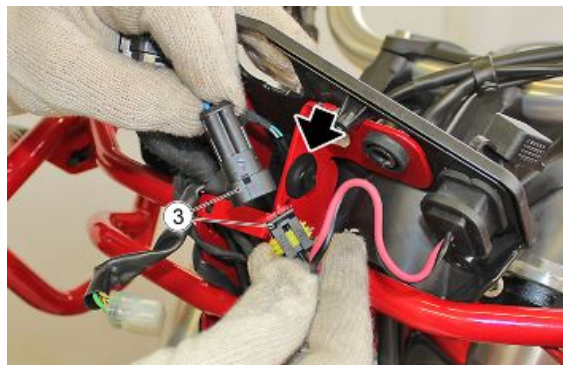
- Remove the instrument panel
- Unscrew and remove the screws (1)



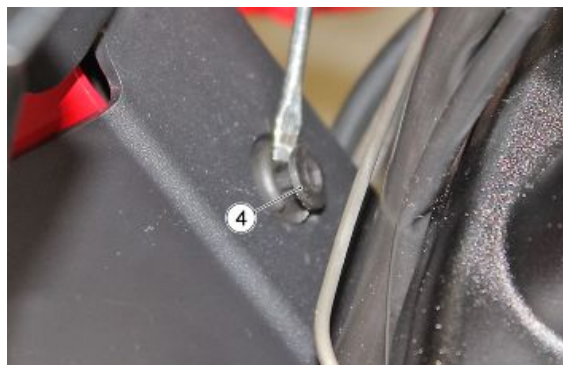
- Remove the instrument panel bracket (2)



- Remove the connector (3) from the guide indicated in the figure
- Disconnect the connector (3)



- Remove the plastic rivet (4)



- Remove the plastic rivets from both sides of the vehicle (5)



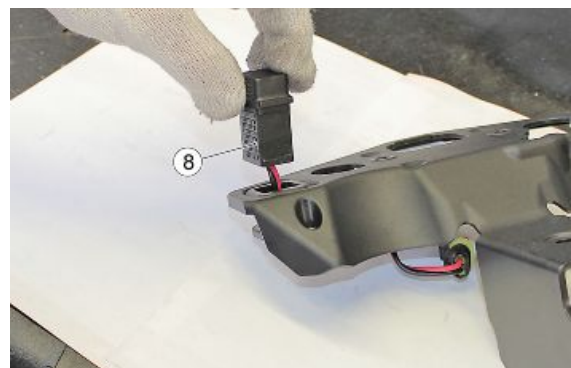
- Unscrew and remove the screws (6)



- Remove the support (7)



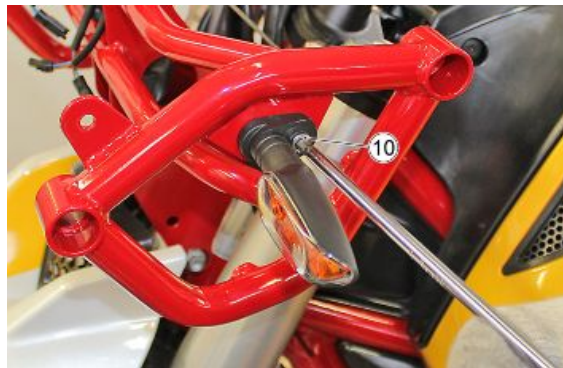
- Remove the USB socket (8)



- Disconnect the front turn indicator connectors (9)



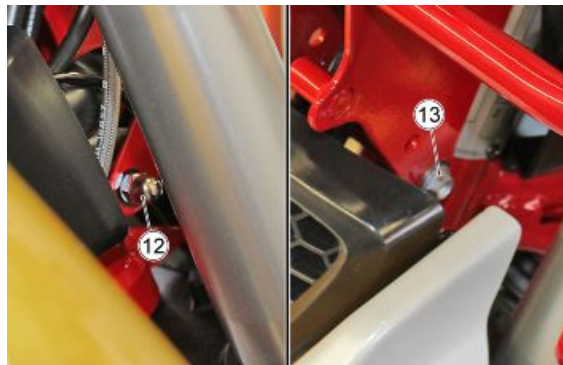
- Unscrew the two screws (10) from both sides of the vehicle



- Remove the front turn indicators from both sides of the vehicle (11)



- Block the nut (12) so that it cannot rotate and remove the screw (13)



- Remove the connector (14) from the guide indicated in the figure
- Disconnect the connector (14)



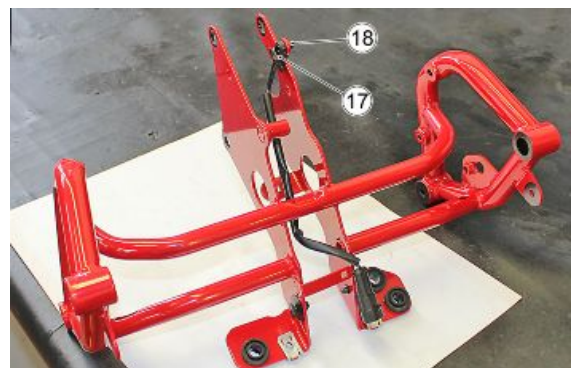
- Remove the main wiring harness (15) from the bracket



- Remove the support (16)



- Remove the clamp (17)
- Remove the air temperature sensor (18)



Battery

REMOVAL

- Remove the glove compartment
- Undo and remove the screw (1)
- Remove the negative cable from the battery (2)
- Refit the screw (1) along with the yoke in the specific seat



- Lift the protective boot (3)
- Undo and remove the screw (4)
- Remove the positive cable (5)
- Refit the screw (4) along with the yoke in the specific seat



- Remove the battery (6)



Tail guard

REAR FAIRINGS REMOVAL

- Remove the luggage rack
- Unscrew and remove the screws (1)
- Unscrew and remove the screws (2)



- Remove the rear fairing (3)



- Undo and remove the screw (4)



- Remove the right rear fairing (5)



- Undo and remove the screw (6)



- Remove the left rear fairing (7)



Copertura terminale

REMOVAL

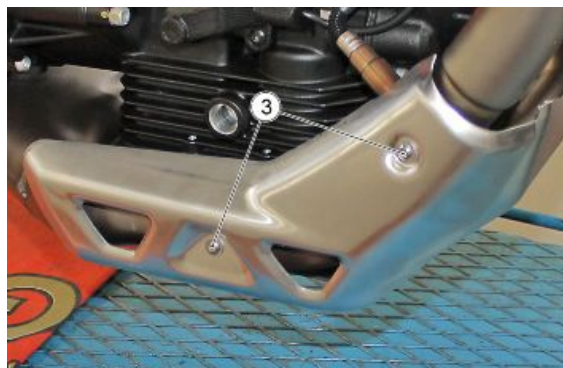
- Unscrew and remove the screws (1)



- Remove the left cover (2)



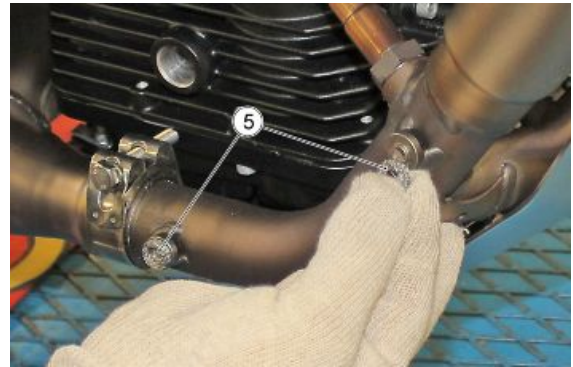
- Unscrew and remove the screws (3)



- Remove the terminal cover (4)



- Retrieve the washers (5)



INDEX OF TOPICS

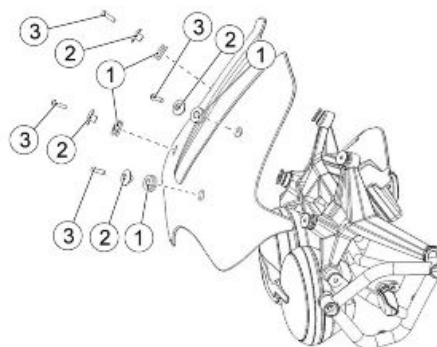
PRE-DELIVERY

PRE DE

Specific operations for the vehicle

WINDSHIELD KIT ASSEMBLY

- The box containing the windshield is in the vehicle packaging. The installation hardware is mounted on the windshield bracket assembled to the vehicle
- Installation begins with the removal of the mounting hardware from the windshield bracket (for each of the four fastening points, made up of: rubber piece, bushing and screw)
- Subsequently, the four rubber pieces (1) are fitted in the respective holes on the windshield, avoiding the use of tools that can damage or scratch the component
- The bushings (2) should be inserted in the holes of the rubber pieces from the front side of the windshield
- The windshield should then be rested on the relative bracket on the vehicle and, supporting it firmly, the screws should be fastened (3), tightening them to the torque indicated on the chart

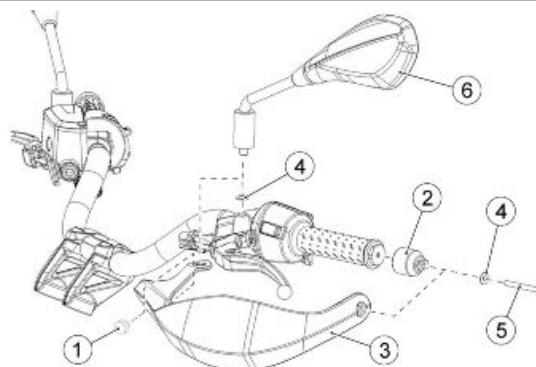


WINDSHIELD KIT TIGHTENING TORQUES

Tightening torque chart	Tightening torques Nm (lbf ft)	Residual torque Nm (lbf ft)
Windshield fastening to windshield bracket	10 Nm (7.38 lbf ft)	8 Nm (5.90 lbf ft)

HANDGUARDS AND REAR VIEW MIRRORS KIT ASSEMBLY

- The box containing the right and left handguards, the anti-vibration weights and the hardware required for assembling the aforementioned components is in the vehicle packaging
- There is also a box containing the rear view mirrors



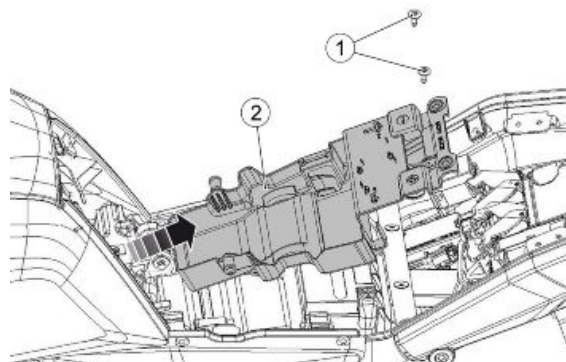
- Installation of the handguards begins with the insertion of the rubber piece (1) in the specific cylindrical lodging on the internal side of the handguards.
- Then, rest the anti-vibration weight (2) in correspondence to the end of the handlebar and on this handguard (3), taking care to line up the inside with the shape of the anti-vibration weight; then, the "T" bushing (4) should be inserted on the handguard and the screw (5) inserted without tightening it all the way.
- Then, insert the other "T" bushing from below on the second handguard fastening hole and screw in the rear view mirror (6)
- Then, tighten the screw (5), observing the tightening torque indicated on the attached chart
- Repeat the same procedure to mount the handguard/rear view mirror on the opposite side

HANDGUARDS/REAR VIEW MIRRORS KIT TIGHTENING TORQUES

Tightening torque chart	Tightening torques Nm (lbf ft)	Residual torque Nm (lbf ft)
Fastening handguard / anti-vibration weight to handlebar	6 Nm (4.43 lb ft)	4.8 Nm (3.54 lb ft)

BATTERY COVER ASSEMBLY

- Remove the saddle, acting on the lock positioned on the licence plate holder and lift it from the rear part, unhooking it from its lodgings in correspondence to the fuel tank
- Remove the screws (1) and extract the battery cover (2) from the front lodgings, sliding it toward the rear



- Place the battery in the appropriate lodging and connect it, taking care to observe the polarity
- Refit the battery cover, inserting it in the appropriate lodgings as indicated in figure "C"
- Insert the screws (1) in the appropriate holes, observing the tightening torque indicated on the attached chart
- Refit the saddle, hooking it in the front part in the appropriate lodgings in correspondence to the fuel tank and lower it at the rear, ensuring that the saddle lock has clicked.

BATTERY COVER KIT TIGHTENING TORQUES

Tightening torque chart	Tightening torques Nm (lbf ft)	Residual torque Nm (lbf ft)
Fastening batter cover to frame	10 Nm (7.38 lb ft)	8 Nm (5.90 lb ft)

A

ABS:

Air filter: 22

B

Battery: 254

Bulbs:

C

Clutch: 28

E

Electrical system: 8, 32

Exhaust: 155, 157

Exhaust manifold: 157

F

Fairings: 212, 234

Fork: 94–96, 102, 111

Front wheel: 122

Fuel: 85, 243

Fuel pump: 85

Fuses: 64

H

Handlebar: 90

Headlight: 29, 216, 221

Horn: 219

I

Identification: 7

Instrument panel: 215

K

Keys: 62

L

License plate holder: 238

M

Maintenance: 16, 176

Mirrors: 214

Mudguard: 248

O

Oil filter: 21

R

Rear wheel: 131

Recommended products: 17

S

Scheduled maintenance: 16

Shock absorbers: 119

Side fairings: 212, 234

Side stand: 152

Spark plug: 17

Spark plugs:

Stand: 152

T

Tank: 243

Transmission: 8

Turn indicators: 219

Tyres: 10

W

Windshield:

Wiring diagram: 59